

Technische Daten: Art.-Nr.: 870710

Wandaußenmaß: 360 x 360 cm

Bohlenstärke: 70 mm



Durch Kunden farblich behandelt

Kontrolliert durch:

Achtung: Alle angegebenen Maße sind ca.-Maße!

3D-Darstellung und Grundriss 870710

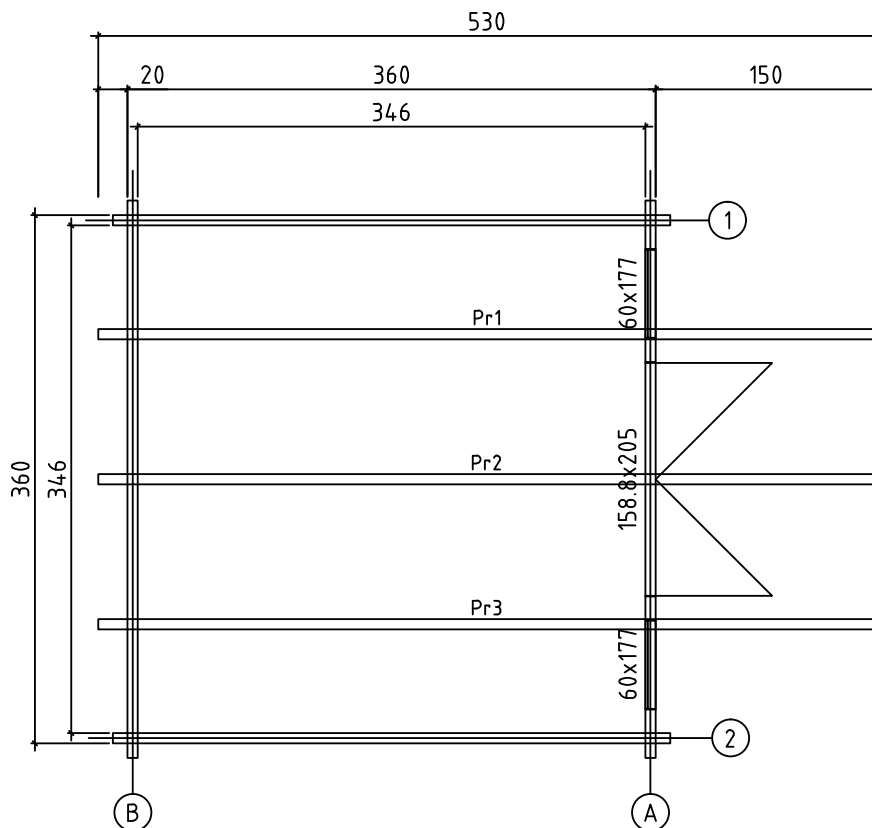
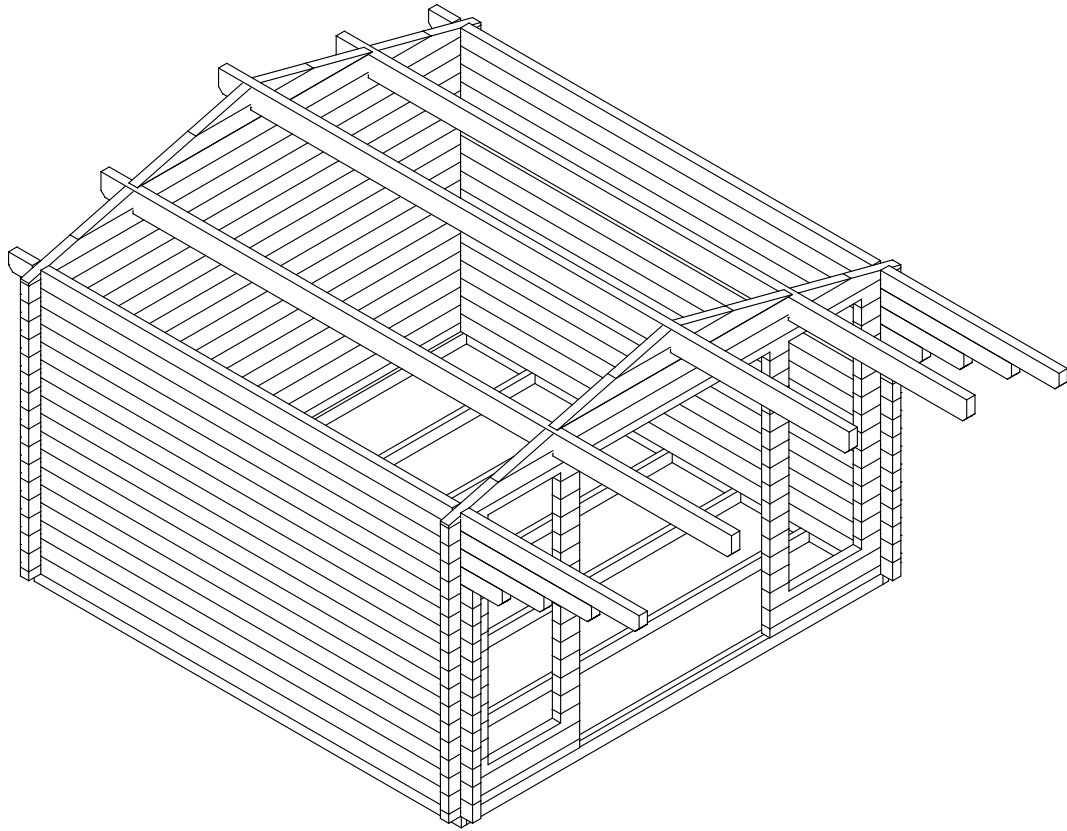



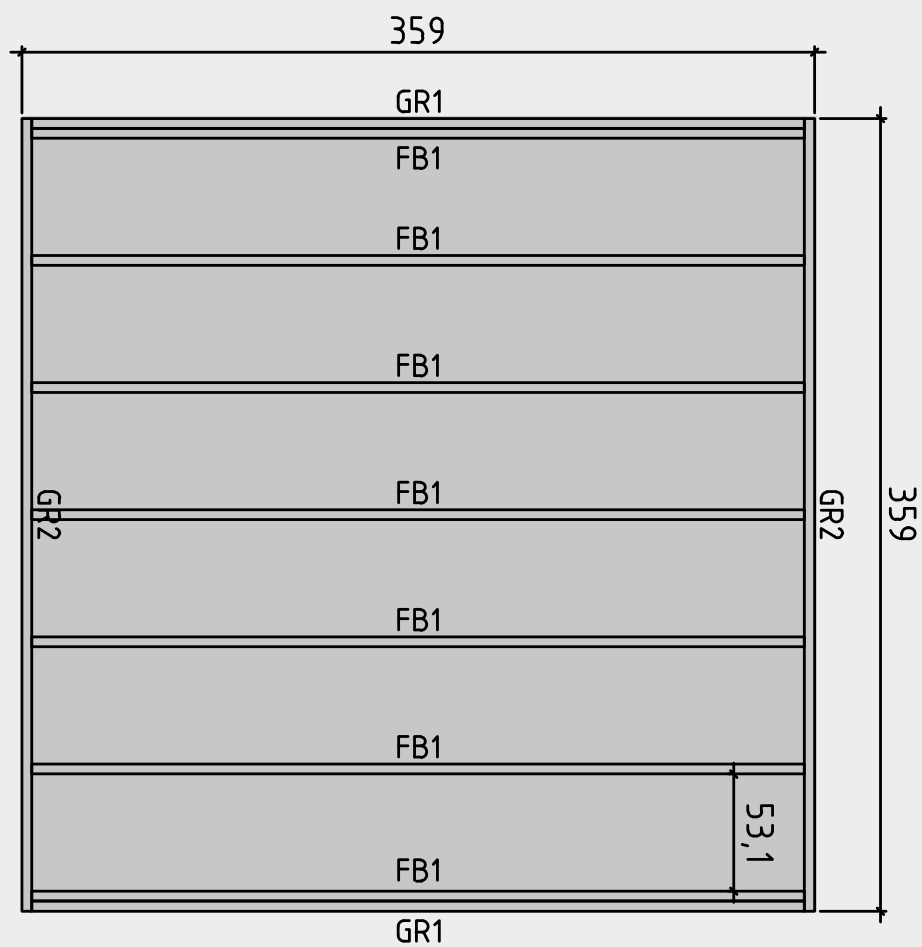

Lagerholzplan und Fundamentplan 870710

Wir empfehlen als Fundament für Ihr Gartenhaus eine vollflächig,
festgegründete gepflasterte oder betonierte Fläche.
Wahlweise ist auch ein Punkt- oder Streifenfundament möglich.

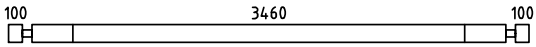
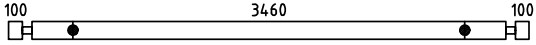
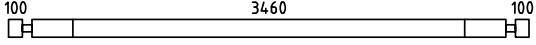
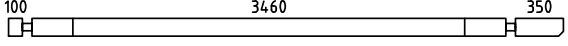
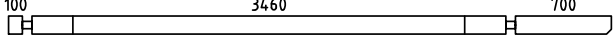
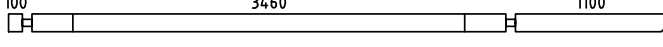
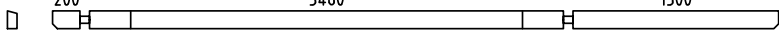
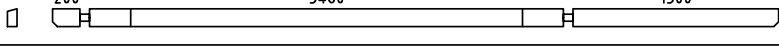
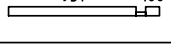
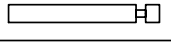
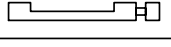

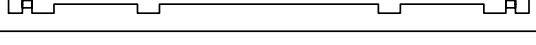
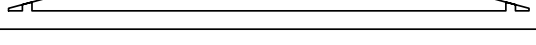
Teileliste 1 870710

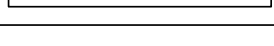
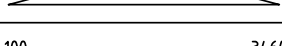
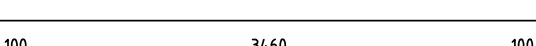
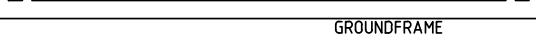
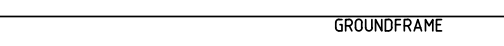
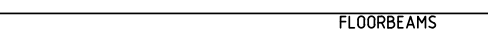
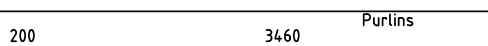
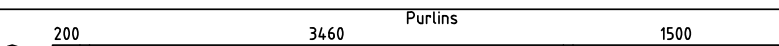
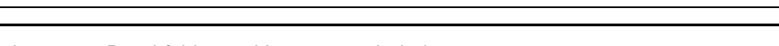
Pos		Quantity	Profil (mm)	Lenght (mm)
001		2	70x130	3800
002		2	70x130	3800
003		22	70x130	3800
004		2	70x130	4050
005		2	70x130	4400
006		2	70x130	4800
007		1	70x130	5300
008		1	70x130	5300
009		2	70x65	1101
010		2	70x130	1101
011		2	70x130	1101
012		26	70x130	331
013		26	70x130	160
014		1	70x130	3800
015		2	70x130	3800
016		8	70x122	464
017		2	70x130	1917
018		2	70x130	1977
019		1	70x65	3800
020		16	70x130	3800
GR2	GROUNDFRAME 	2	45x90	3590
GR1	GROUNDFRAME 	2	45x90	3500
FB1	FLOORBEAMS 	7	45x90	3500
Pr1	Purlins 	1	70x170	5300
Pr2	Purlins 	1	70x170	5300

Teileliste 3

870710

POS	ST.	B	H	L	Teileliste
FB1	Vt. spetsi				FUNDMENTHOLZER
F1	12 m ²	28		3455	FUSSBODENBRETTER 40/31/26
PR	3	70	170	5300	DACHBALKEN
RB1	22,5 m ²	20		2120	DACHBRETTER 122/94/78
R1	2	20	120	5300	Traufenbretter
R2	2	45	65	5300	Traufenbretter
R3	4	20	120	2300	Giebelabschlussleiste
R4	4	20	90	2300	Giebelabschlussleiste
WN06	2	600	1770		<p style="margin-top: 10px;">Sliding slats 30x30x1575 mm - 4 pcs.</p>
DR16	1	1588	2050		
P1	15 m	20	40		Fußbodenleiste
P2	6+6	20	90	2030	Türleiste DR 16, Fensterleiste WN 06
P3	1+1	20	90	3440	Türleiste DR 16, Fensterleiste WN 06
P4	2+2	20	90	540 570	Fensterleiste WN 06

Wandplan 1 und 2 870710

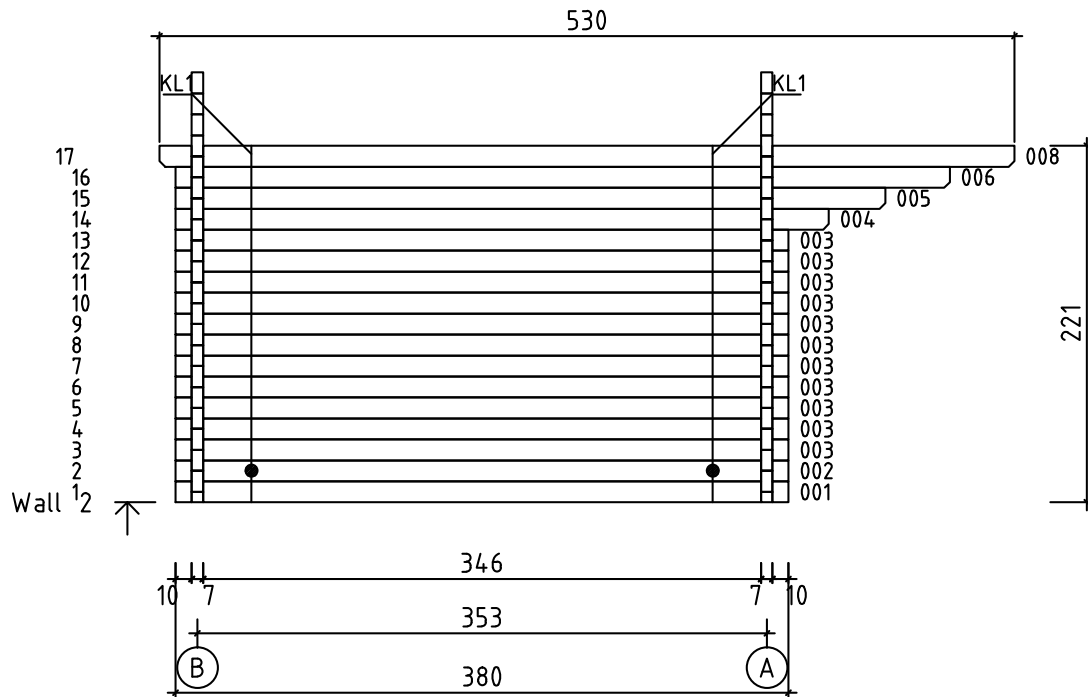
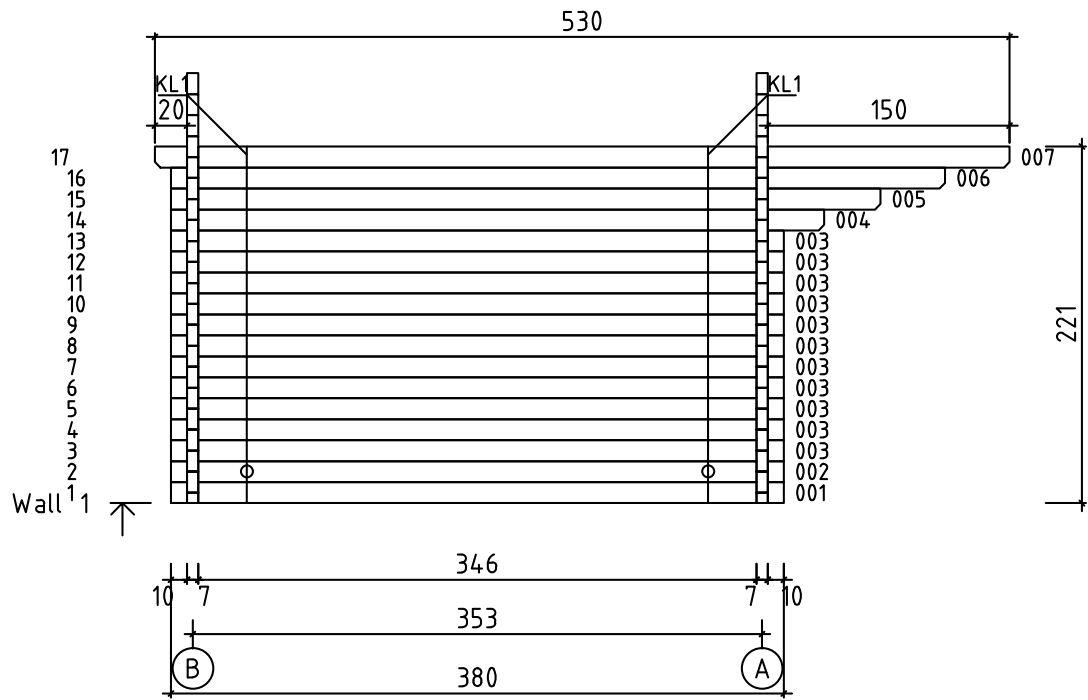

Wandplan A und B 870710

