

# Technische Daten: Art.-Nr.: 870700

Wandaußenmaß: 360 x 300 cm

Bohlenstärke: 70 mm



Hammerfest 70-B. Durch Kunden farblich behandelt

Kontrolliert durch:

Achtung: Alle angegebenen Maße sind ca.-Maße!

# 3D-Darstellung und Grundriss 870700

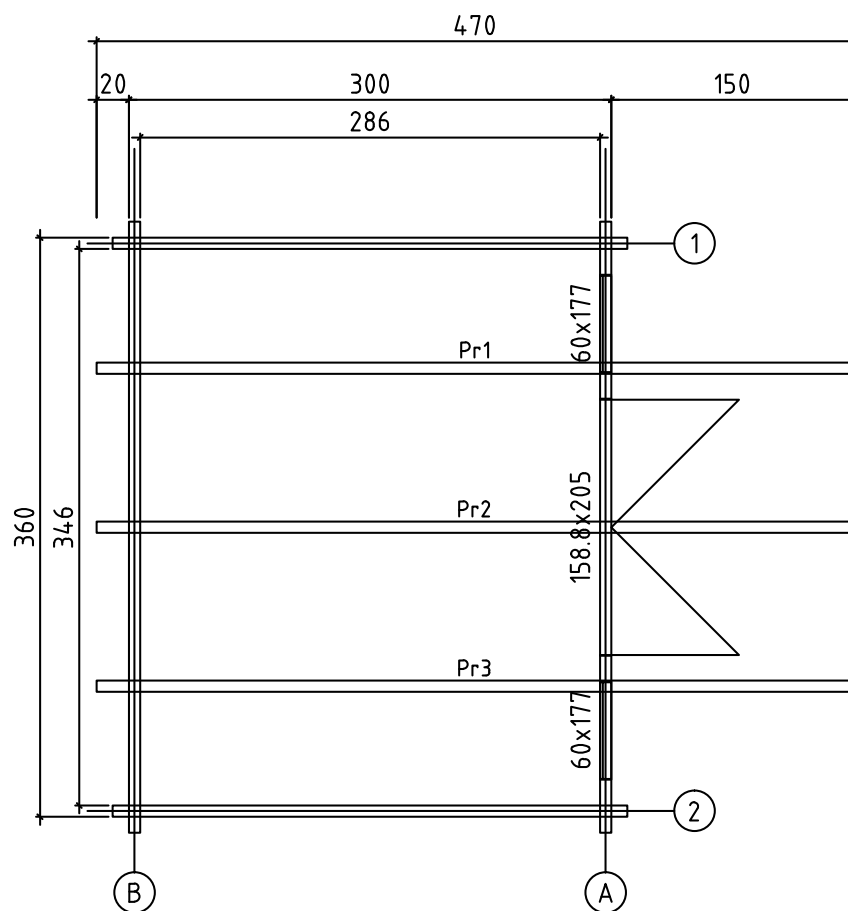
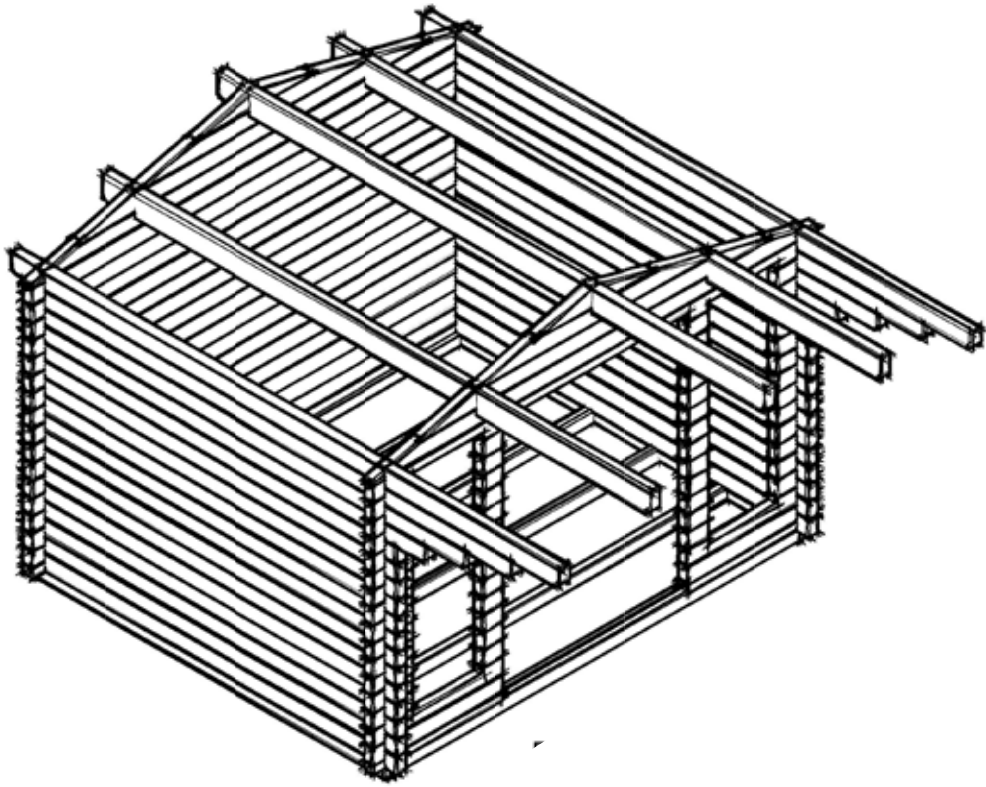





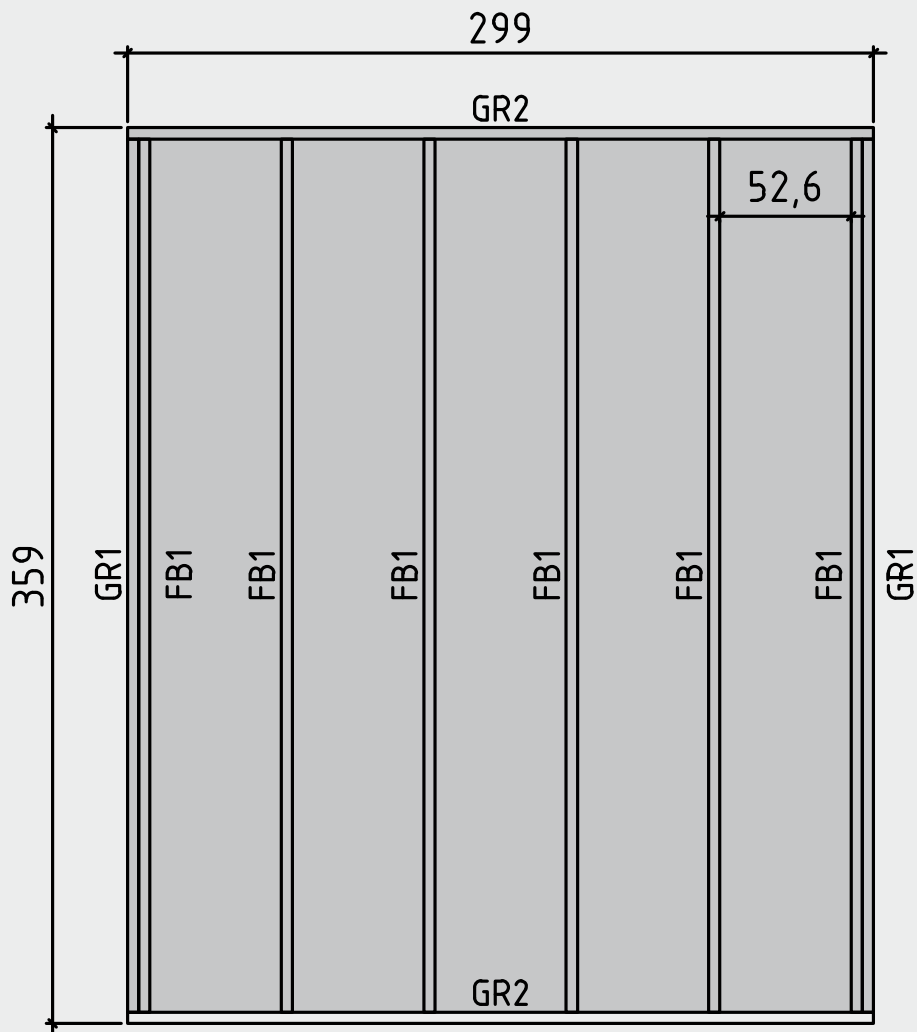

# Lagerholzplan und Fundamentplan 870700

Wir empfehlen als Fundament für Ihr Gartenhaus eine vollflächig,  
festgegründete gepflasterte oder betonierte Fläche.  
Wahlweise ist auch ein Punkt- oder Streifenfundament möglich.

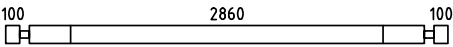
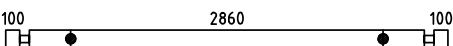
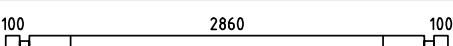
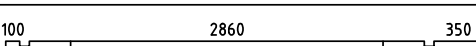
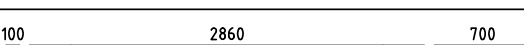
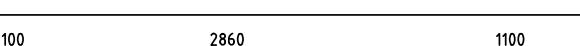
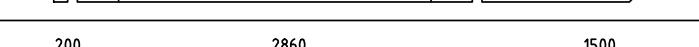
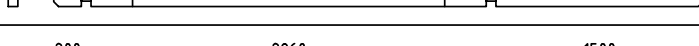
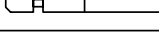
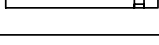
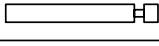

# Teileliste 1

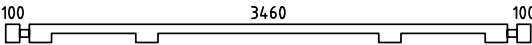
## 870700

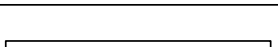
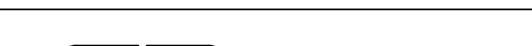
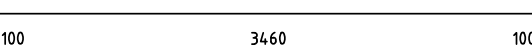
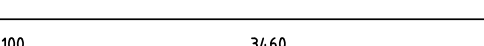
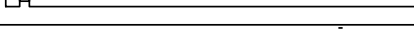
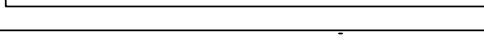
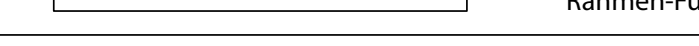
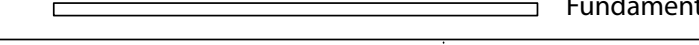
Pos		Quantity	Profil (mm)	Lenght (mm)
001		2	70x130	3200
002		2	70x130	3200
003		22	70x130	3200
004		2	70x130	3450
005		2	70x130	3800
006		2	70x130	4200
007		1	70x130	4700
008		1	70x130	4700
009		2	70x65	1101
010		2	70x130	1101
011		2	70x130	1101
012		26	70x130	331
013		26	70x130	160
014		1	70x130	3800
015		2	70x130	3800
016		8	70x122	464
017		2	70x130	1917
018		2	70x130	1977
019		1	70x65	3800
020		16	70x130	3800
GR1	 Rahmen-Fundamentholz	2	45x90	3500
GR2	 Rahmen-Fundamentholz	2	45x90	2990
FB1	 Fundamentholz	6	45x90	3500
Pr1	 Pfetten	1	70x170	4700
Pr2	 Pfetten	1	70x170	4700



# Teileliste 3

## 870700

POS	ST.	B	H	L	Teileliste
FB1	Vt. spetsi				FUNDMENTHOLZER
F1	9,89 m <sup>2</sup>	28		2855	FUSSBODENBRETTER 40/31/26
PR	3	70	170	4700	DACHBALKEN
RB1	19,92 m <sup>2</sup>	20		2120	DACHBRETTER 122/94/78
R1	2	20	120	4700	Traufenbretter
R2	2	45	65	4700	Traufenbretter
R3	4	20	120	2300	Giebelabschlussleiste
R4	4	20	90	2300	Giebelabschlussleiste
WN06	2	600	1770		<p>Schiebelamellen 30x30x1575 mm - 4 pcs.</p>
DR16	1	1588	2050		
P1	14 m	20	40		Fußbodenleiste
P2	6+6	20	90	2030	Türleiste DR 16, Fensterleiste WN 06
P3	1+1	20	90	3440	Türleiste DR 16, Fensterleiste WN 06
P4	2+2	20	90	540 570	Fensterleiste WN 06

# Details 870700

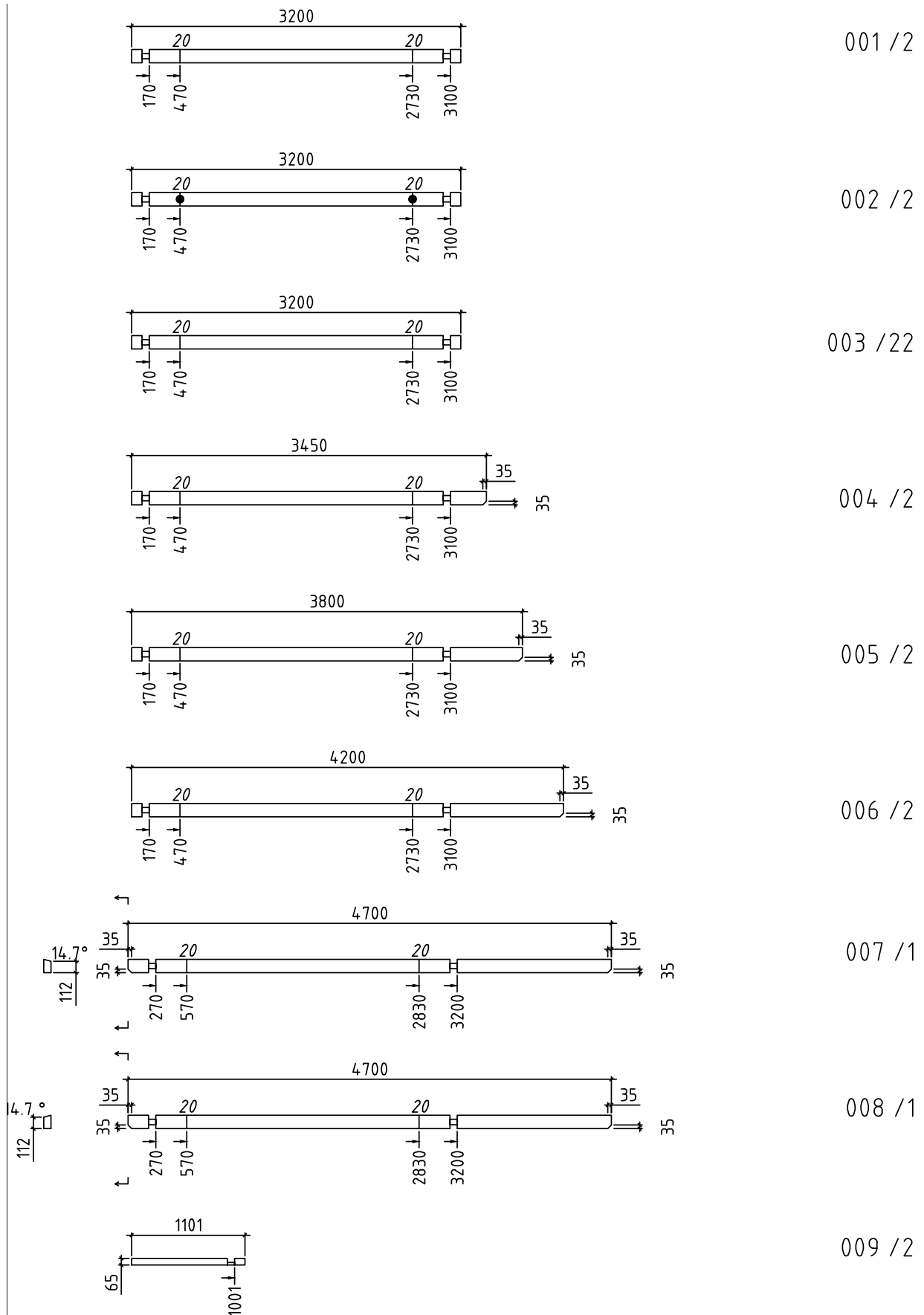

# Details 870700

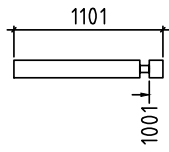

010 / 2

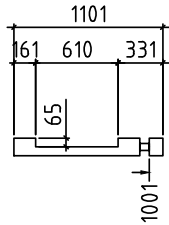

011 / 2

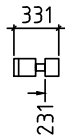

012 / 26



013 / 26

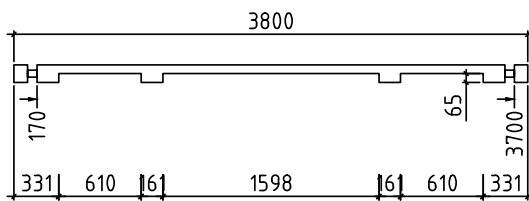

014 / 1

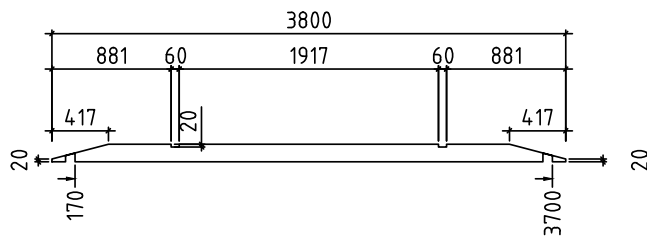

015 / 2

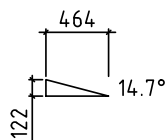

016 / 8

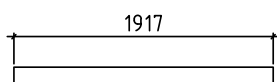

017 / 2

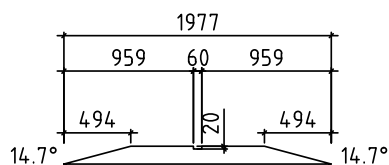

018 / 2



# Details 870700

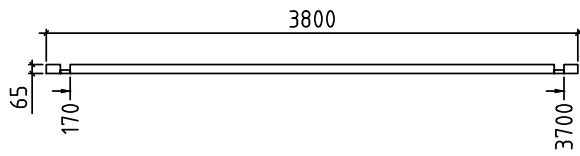

019 / 1

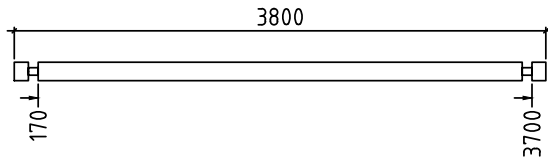

020 / 16

# Details 870700

## Rahmen-Fundamentholz

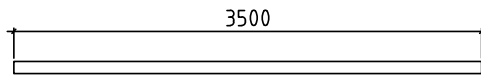

GR1 / 2  
45x90

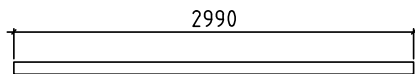

GR2 / 2  
45x90

## Fundamentholz

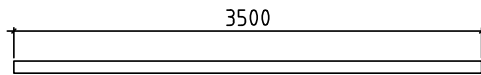

FB1 / 6  
45x90

## Pfetten

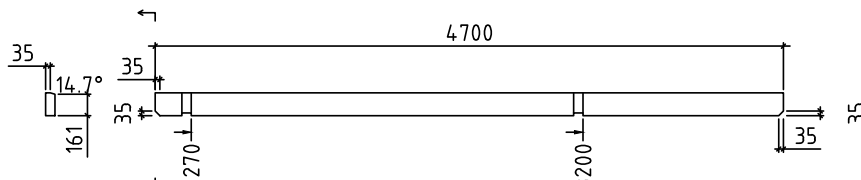

Pr1 / 1  
70x170(60x150)

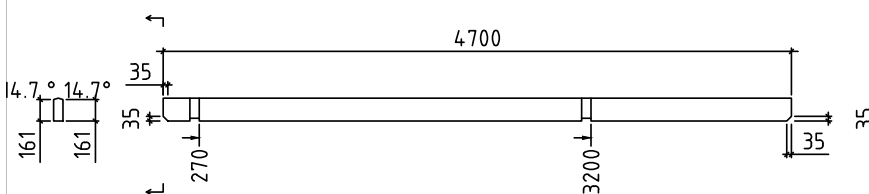

Pr2 / 1  
70x170(60x150)

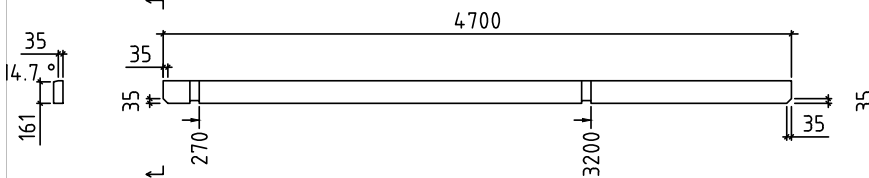

Pr3 / 1  
70x170(60x150)

# Wandplan 1 und 2 870700

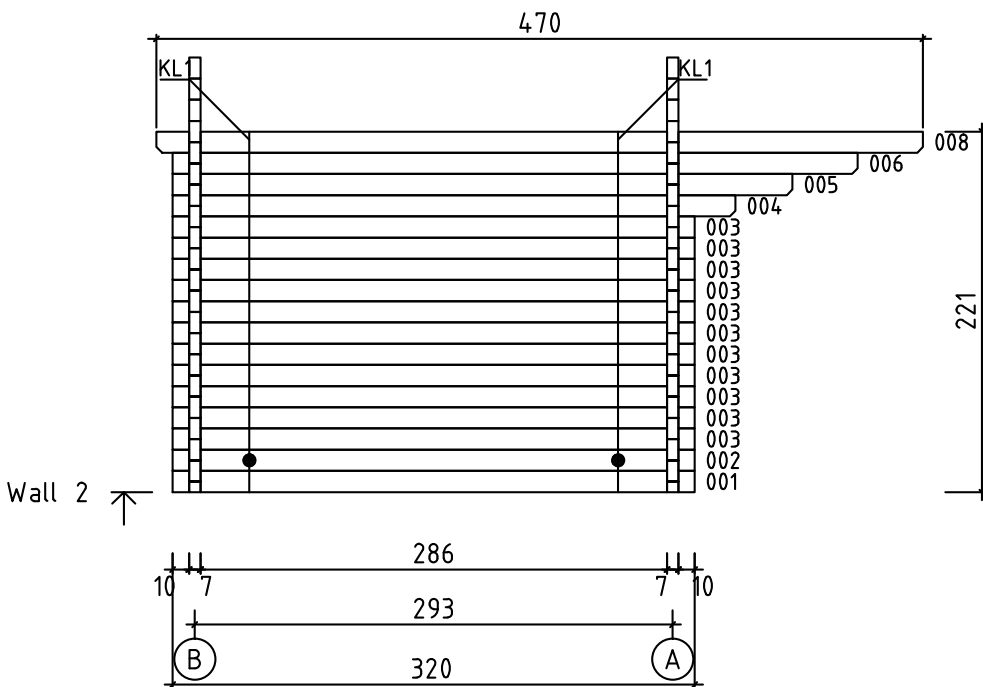
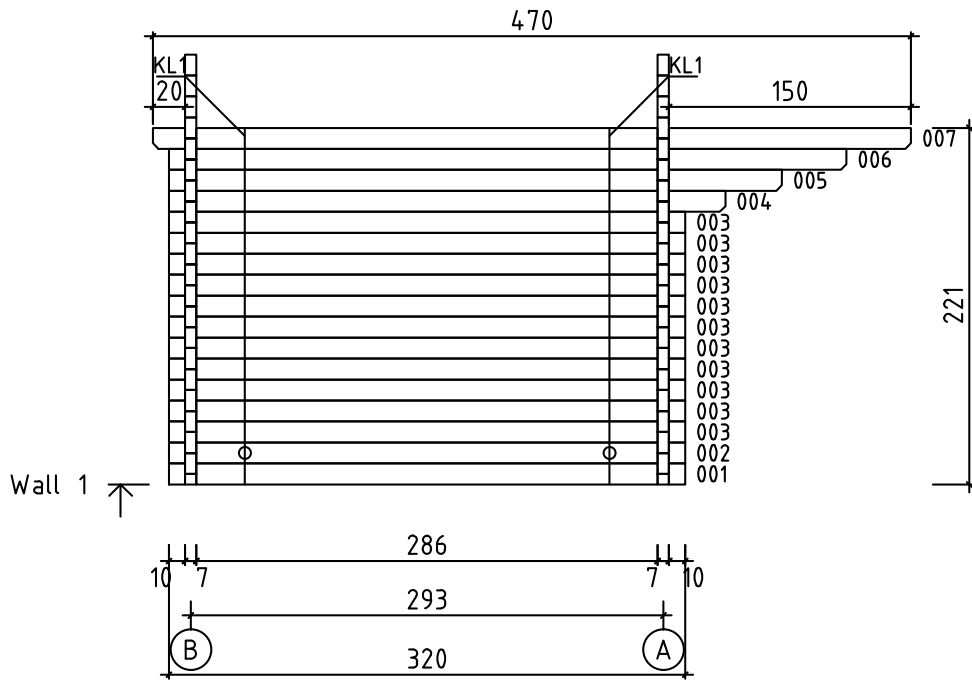

# Wandplan A und B 870700

