

Technische Daten



Durch Kunden farblich behandelt.

Artikelnummer:

527 010

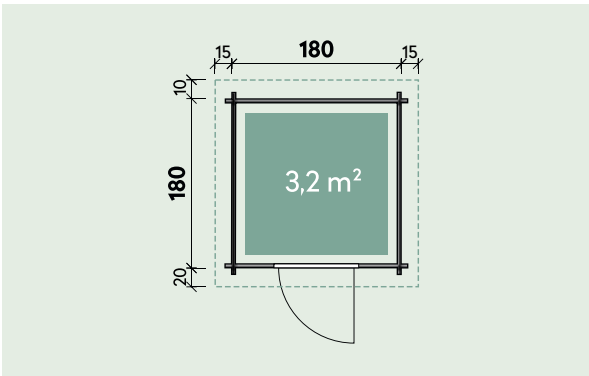

Kontrolliert durch:

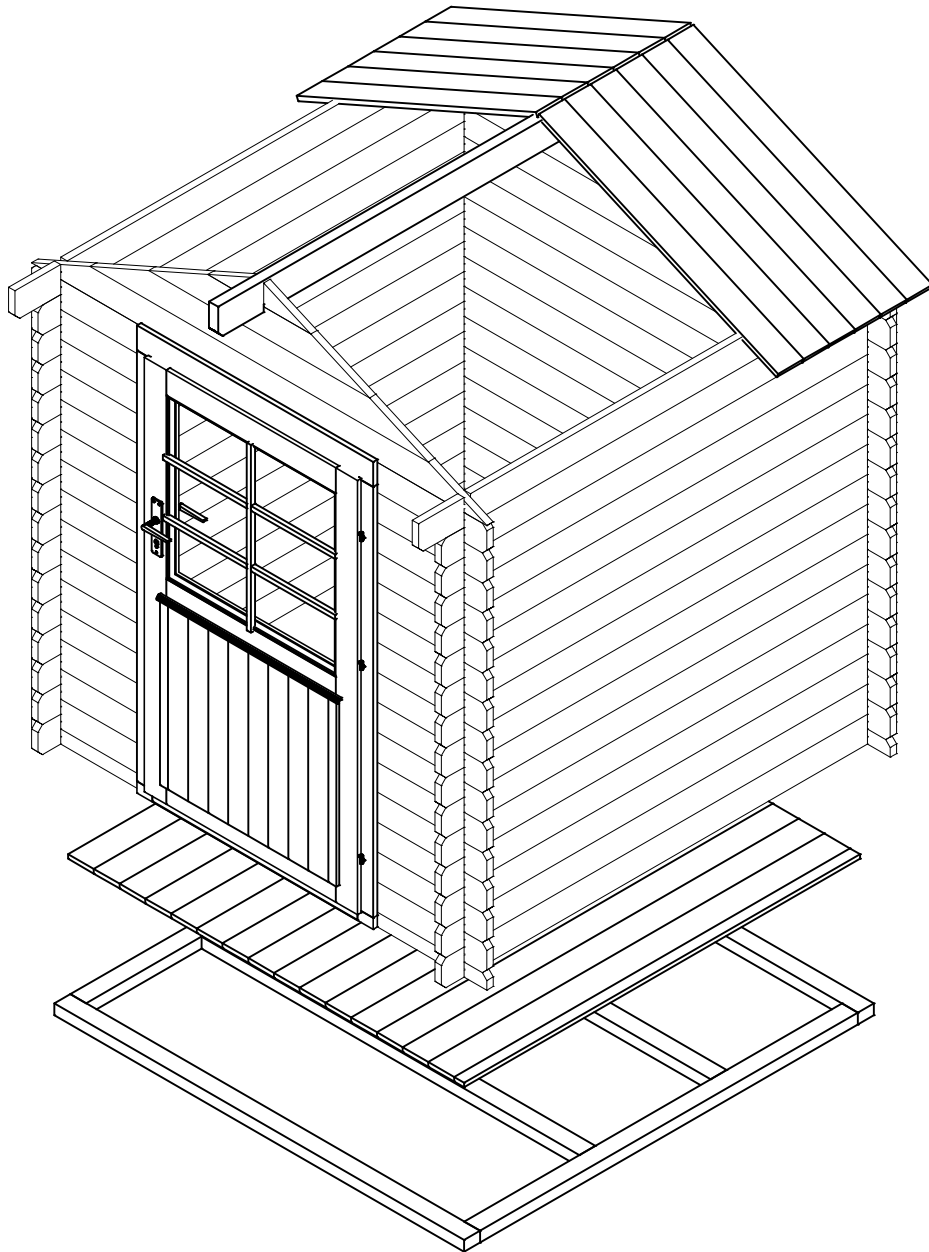

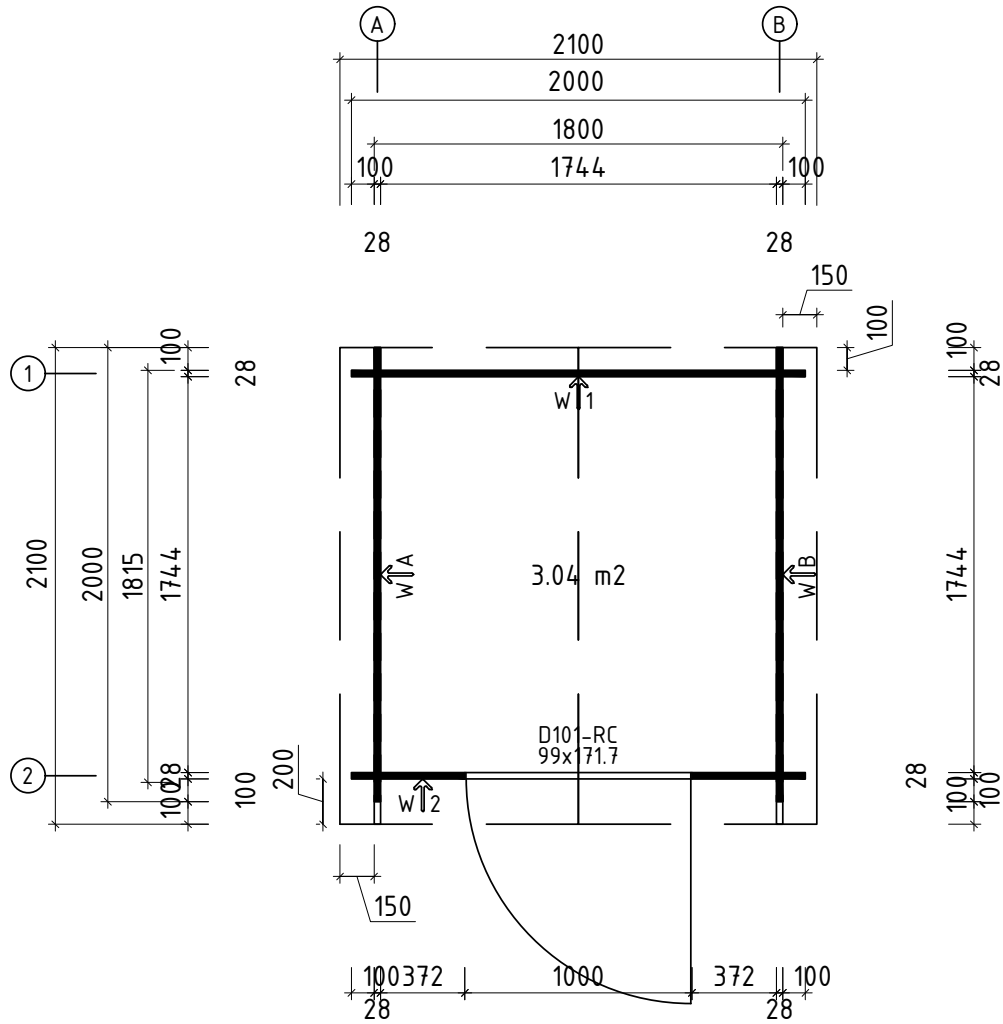

*Fenster und Türen sind mit Sprossen





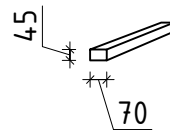
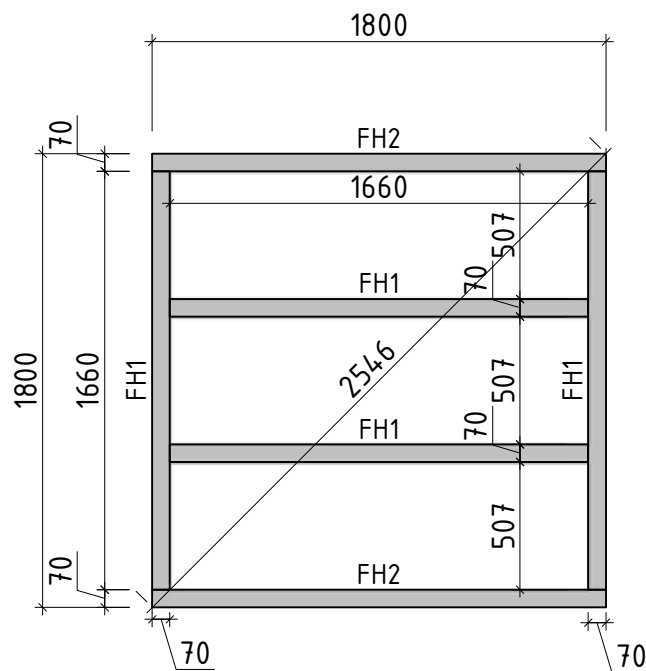

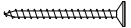

Q2 – Qualitätsklasse für Fenster und Türen

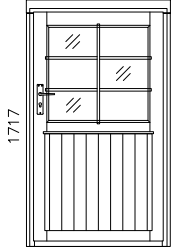
Wir empfehlen als Fundament für Ihr Gartenhaus eine vollflächig festgegründete, gepflasterte oder betonierte Fläche. Wahlweise ist auch ein Punkt- oder Streifenfundament möglich.



Nr.		Stck.	Profil (mm)	Länge (mm)
001		1	28x114	2100
002		1	28x114	2100
004		1	28x57	2000
005		45	28x114	2000
008		2	28x57	500
009		30	28x114	500
W1-1		1		
W2-1		1		
FH2	FUNDAMENTHÖLZER (imprägniert) 	2	70x45	1800
FH1	FUNDAMENTHÖLZER (imprägniert) 	4	70x45	1660
PF1	PFETTEN 	1	40x120	2100
	DACHBRETTER	38+1	113x18	1150
	FUSSBODENBRETTER	16+1	113x18	1740
	FUSSBODENLEISTEN		18x40	8.0lfm
G02-1	GIEBELBRETTER 18x120	4	18x120	1230
G06-1	GIEBELDECKLEISTEN 18x58	4	18x58	1230
T06-1	TRAUFELEISTEN 18x40	2	18x40	2100
T01-1	TRAUFENBRETTER 18x95	2	18x95	2100
SM-1	Sturmleisten	4	18x40	1710
GS	Giebelsegment	2		
SH	Schlaghölzer	3		
NG2 550	NÄGEL 2.5x50 Dachbretter	152		
NG2 550	NÄGEL 2.5x50 Fussbodenbretter	128		

Nr.		Stck	Profil (mm)	Länge (mm)
SR3 030	SCHRAUBEN 3.0x30 Fussbodenleisten 	14		
SR3 030	SCHRAUBEN 3.0x30 Traufenleisten 	12		
SR3 545	SCHRAUBEN 3.5x45 Giebelbretter 	16		
SR3 545	SCHRAUBEN 3.5x45 Giebeldeckleisten 	16		
SR3 545	SCHRAUBEN 3.5x45 Giebelsegment 	4		
SR3 545	SCHRAUBEN 3.5x45 Traufenbretter 	12		
SR5 0100	SCHRAUBEN 5.0x100 Fundamenthölzer 	24		
SS013	Schloßschrauben M8x60 Mutter M8 U-Scheibe Ø25 - Befestigung für Sturmleisten 	12		

Nr.		Stck.	Profil (mm)	Länge (mm)
	<p style="text-align: center;">TÜR 990x1717 D2-S28R-56C-09901717</p> <div style="display: flex; justify-content: space-between;"> <div style="text-align: center;"> <p>Q2 D101-RC 990</p>  </div> <div style="border: 1px solid black; padding: 5px; width: 150px;"> <p>Right handed / DIN rechts / paremakäeline</p> </div> </div> <div style="display: flex; justify-content: space-between; margin-top: 10px;"> <div style="text-align: center;"> <p>Clear opening/ durchgangsmaß/ ava suurus 902x1629mm</p>  </div> </div> <div style="display: flex; justify-content: space-between; margin-top: 10px;"> <div style="text-align: center;"> <p>Clear float glass klares Floatglas kirgas klaas 739x695mm</p>  </div> </div>	1		
PROSS H1-1	Q2-Q3-1 Muntins - Sprossen - Prossid horizontal 18x18 	2	18x18	764
PROSS V2-1	Q2-Q3-2 Muntins - Sprossen - Prossid vertical 18x18 	1	18x18	720
SR30 22-01	3.0x20ÜP Muntins - Sprossen - Prossid 	6		
UL-Q 2-Q3	Q2-Q3 Door handle - Türgriff - Ukselink 	1		
LS-Q4	Q4 Cylinder lock - Zylinderschloss - Lukusüdamik 	1		
	✓ - bitte selber anpassen (falls nötig)!			

