

Benennung:  
 ACO DRAIN Multiline V 100 Gußstegrost Kl.C250  
 L= 0,5 m  
 Art.-Nr. 12670

	Datum	Name
Gez.	13.10.2003	Ebeling
Upd.	14.08.2007	debeling
Norm		



**ACO Tiefbau**

ACO Tiefbau Vertrieb GmbH  
 24755 Rendsburg, Postfach 320  
 Tel. 04331/ 354-500  
 FAX 04331/ 354-350  
 www.aco-tiefbau.de

Zeichnung-Nr.  
 G1-M01-949-3

Technische Änderungen vorbehalten

Schutzvermerk gemäß DIN 34

Ers. für:

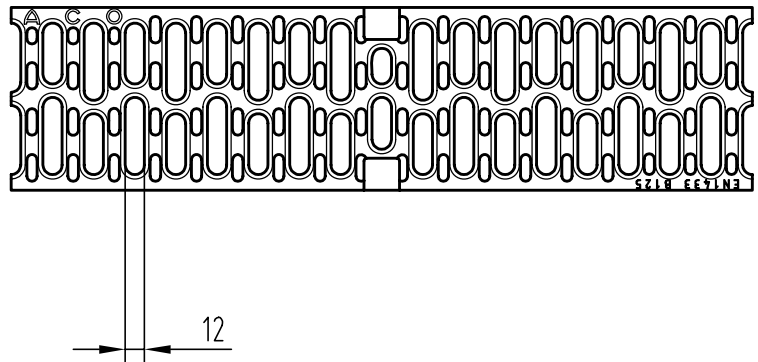
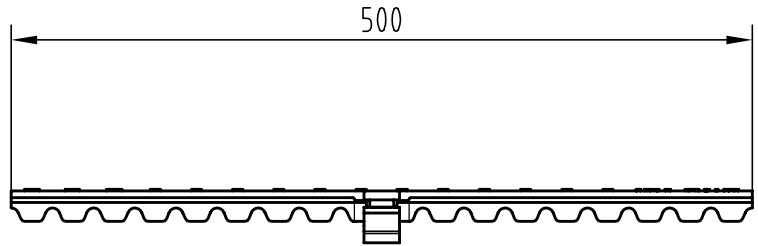
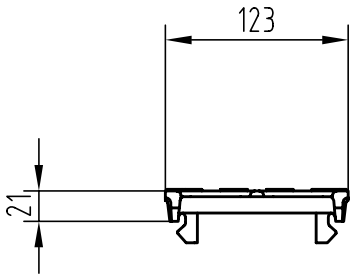

Benennung:  
**ACO DRAIN Multiline V100 Gußstegrost Kl.B125**  
 SK - Design, L= 0,5 m  
 Art.-Nr. 12676

	Datum	Name
Gez.	04.10.2006	debelinq
Upd.	14.08.2007	debelinq
Norm		



**ACO Tiefbau**

**ACO Tiefbau Vertrieb GmbH**  
 24755 Rendsburg, Postfach 328  
 Tel. 04331/ 354-580  
 FAX 04331/ 354-358  
 www.aco-tiefbau.de

Zeichnung-Nr.  
**G1-M01-1105-3**

Technische Änderungen vorbehalten

Schutzvermerk gemäß DIN 34

Ers. für:

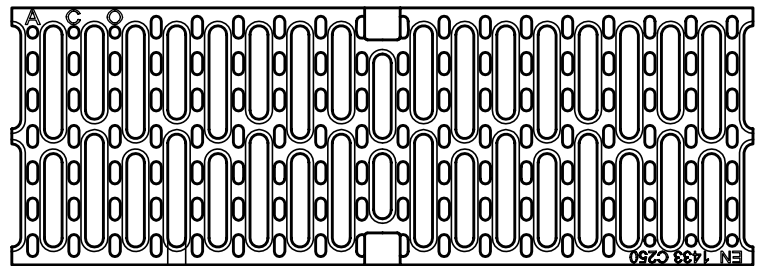
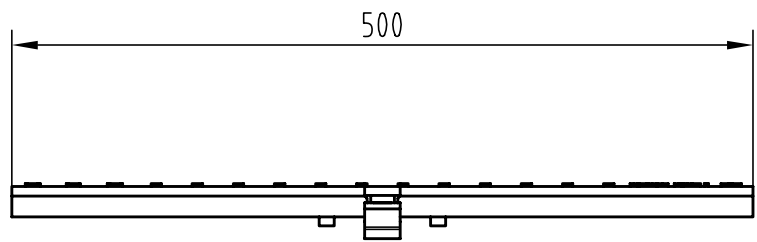
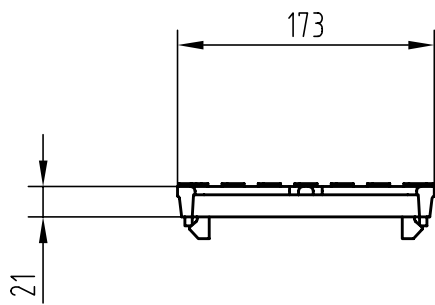

Benennung:  
**ACO DRAIN Multiline V 150 Gußrost Kl.C250**  
 0,5 m  
 Art.-Nr. 13070

	Datum	Name
Gez.	16.09.2004	debeling
Upd.	25.04.2007	debeling
Norm		



**ACO Tiefbau**

**ACO Tiefbau Vertrieb GmbH**  
 24755 Rendsburg, Postfach 328  
 Tel. 04331 / 354-580  
 FAX 04331 / 354-358  
 www.aco-tiefbau.de

Zeichnung-Nr.  
**G1-M01-994-3**

Technische Änderungen vorbehalten

Schutzvermerk gemäß DIN 34

Ers. für:

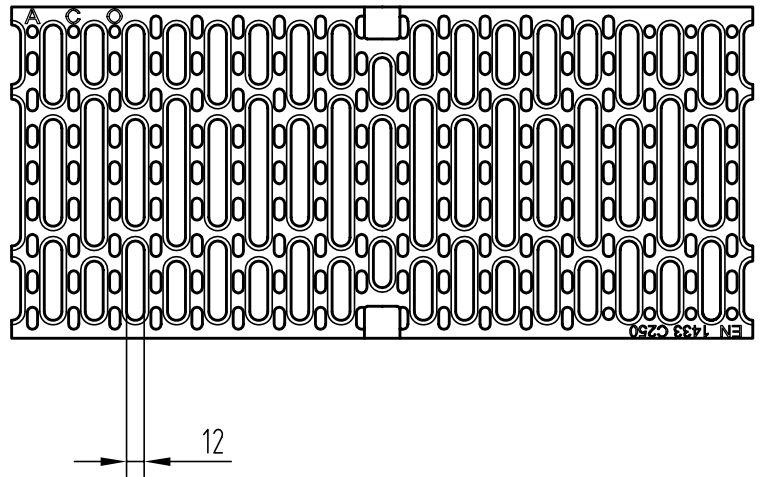
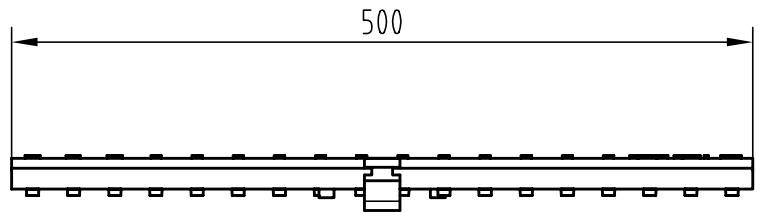
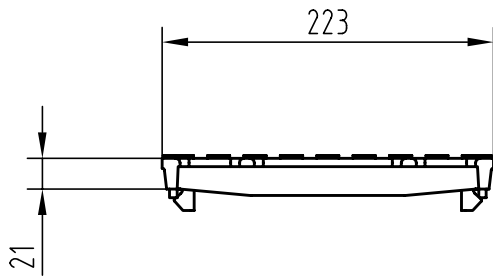

Benennung:  
**ACO DRAIN Multiline V 200 Guss Stegrost Kl.C250**  
 0,5 m  
 Art.-Nr. 13470

	Datum	Name
Gez.	12.02.2004	Ebeling
Upd.	08.05.2007	debeling
Norm		



**ACO Tiefbau**

**ACO Tiefbau Vertrieb GmbH**  
 24755 Rendsburg, Postfach 328  
 Tel. 04331 / 354-580  
 FAX 04331 / 354-358  
 www.aco-tiefbau.de

Zeichnung-Nr.  
**G1-M01-966-3**

Technische Änderungen vorbehalten

Schutzvermerk gemäß DIN 34

Ers. für:

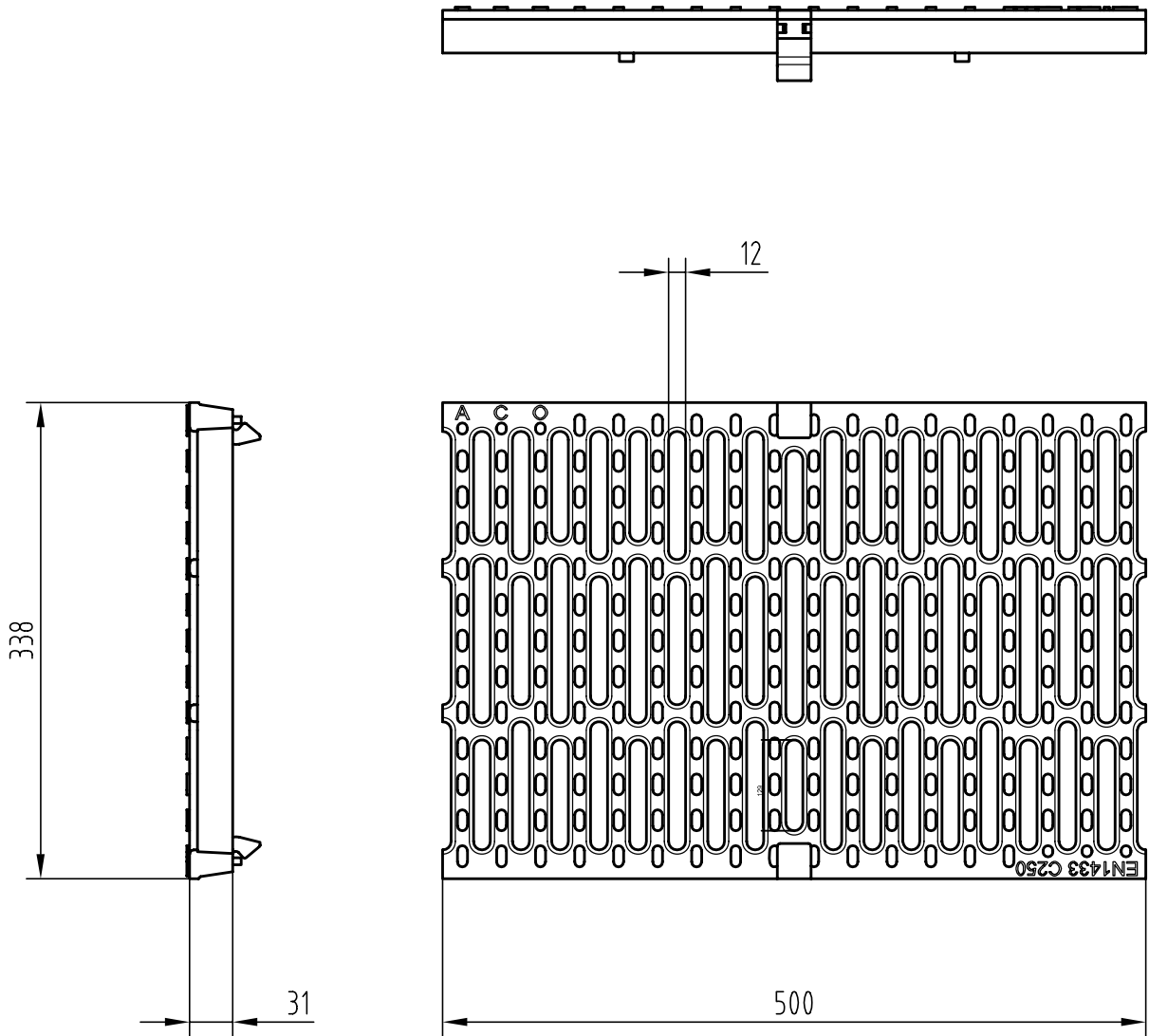

Benennung:  
**ACO DRAIN Multiline V 300 Guss-Stegrost Kl.C250**  
 0,5 m  
 Art.-Nr. 13870

	Datum	Name
Gez.	29.08.2005	debeling
Upd.	15.05.2007	debeling
Norm		



**ACO Tiefbau**

**ACO Tiefbau Vertrieb GmbH**  
 24755 Rendsburg, Postfach 328  
 Tel. 04331 / 354-580  
 FAX 04331 / 354-358  
 www.aco-tiefbau.de

Zeichnung-Nr.  
**G1-M01-1036-3**

Technische Änderungen vorbehalten

Schutzvermerk gemäß DIN 34

Ers. für:

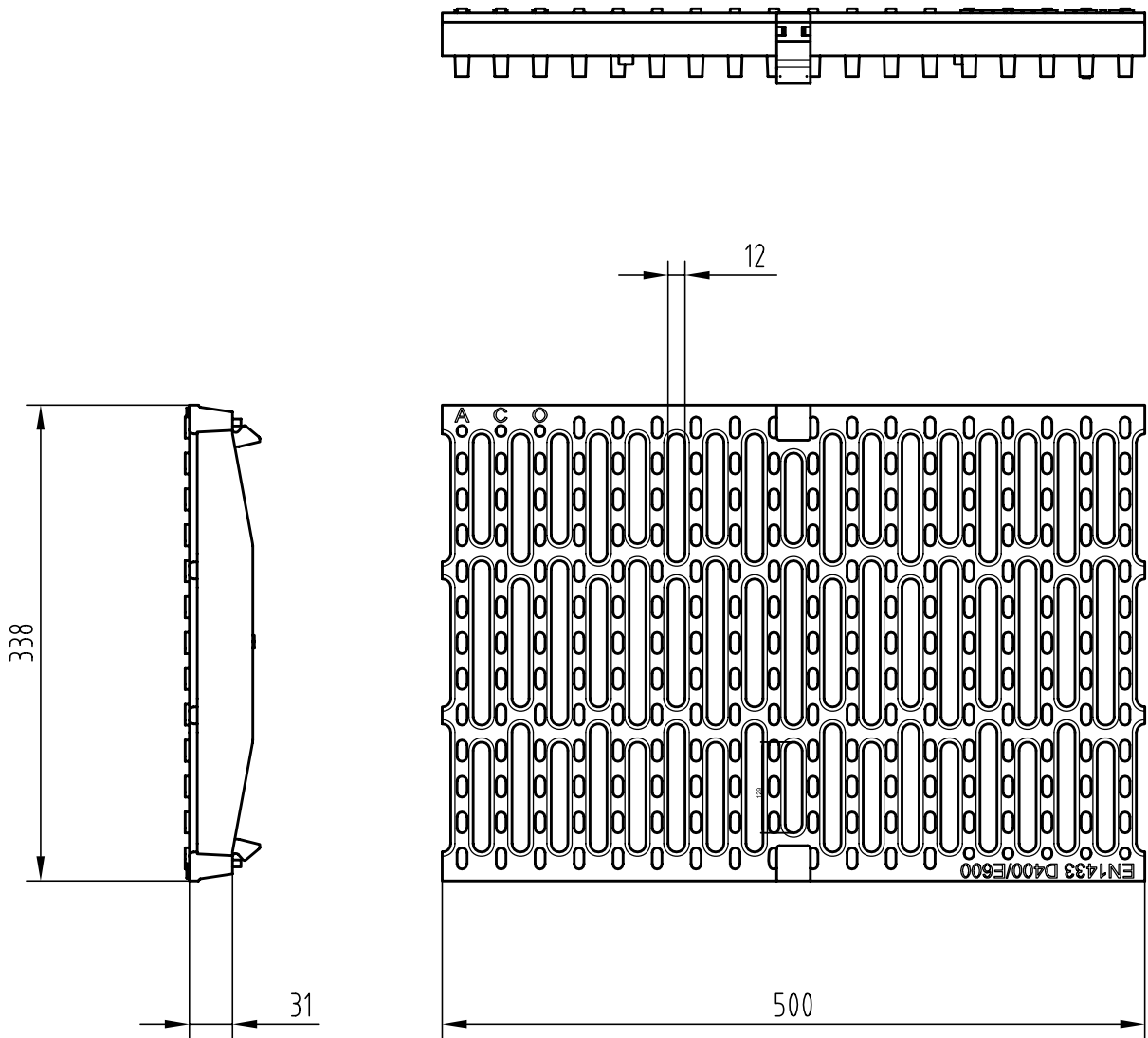

Benennung:  
**ACO DRAIN Multiline V 300 Guss-Stegrost Kl.E600**  
 0,5 m  
 Art.-Nr. 13871

	Datum	Name
Gez.	29.08.2005	debeling
Upd.	15.05.2007	debeling
Norm		



**ACO Tiefbau**

**ACO Tiefbau Vertrieb GmbH**  
 24755 Rendsburg, Postfach 328  
 Tel. 04331 / 354-580  
 FAX 04331 / 354-358  
 www.aco-tiefbau.de

Zeichnung-Nr.  
**G1-M01-1037-3**

Technische Änderungen vorbehalten

Schutzvermerk gemäß DIN 34

Ers. für:

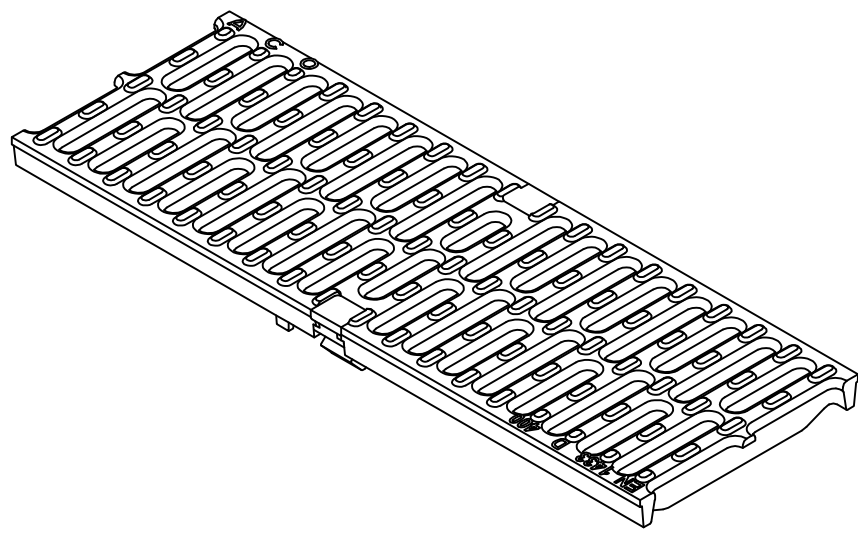
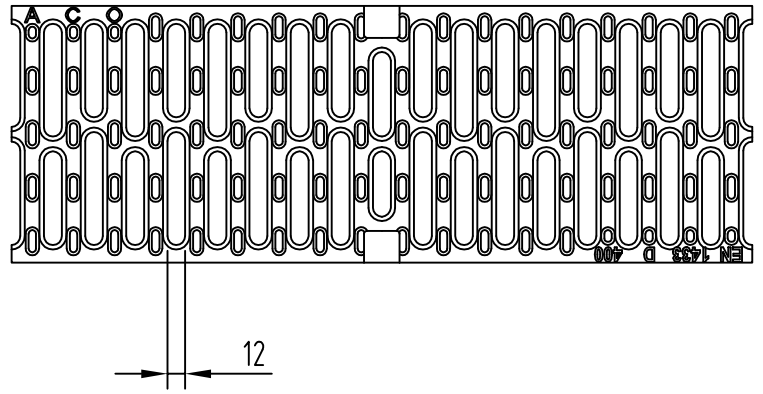
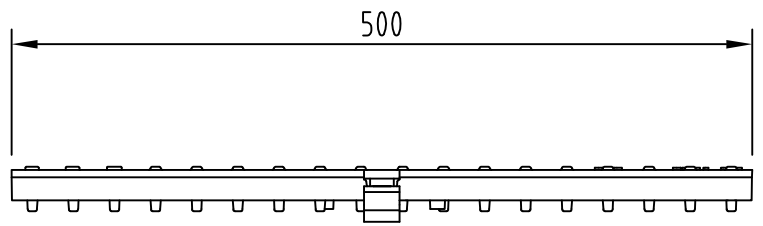
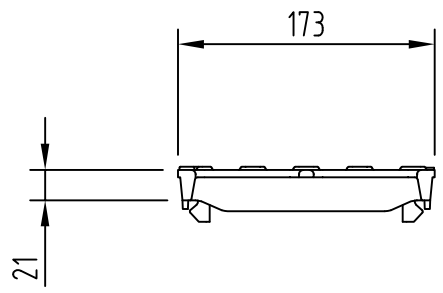

Benennung:  
 ACO DRAIN Multiline V 150 Guss Stegrost EN-GJS  
 L=0,5 m, Kl. D400  
 Art.-Nr. 23164

	Datum	Name
Gez.	04.08.2014	debeling
Upd.	20.01.2015	debeling
Norm		



ACO Tiefbau Vertrieb GmbH  
 24755 Rendsburg, Postfach 320  
 Tel. 04331 / 354-500  
 FAX 04331 / 354-350  
 www.aco-tiefbau.de

Zeichnung-Nr.  
 G1-M01-1470-3

Index  
 000

Technische Änderungen vorbehalten

Schutzvermerk gemäß DIN 34

Ers. für:

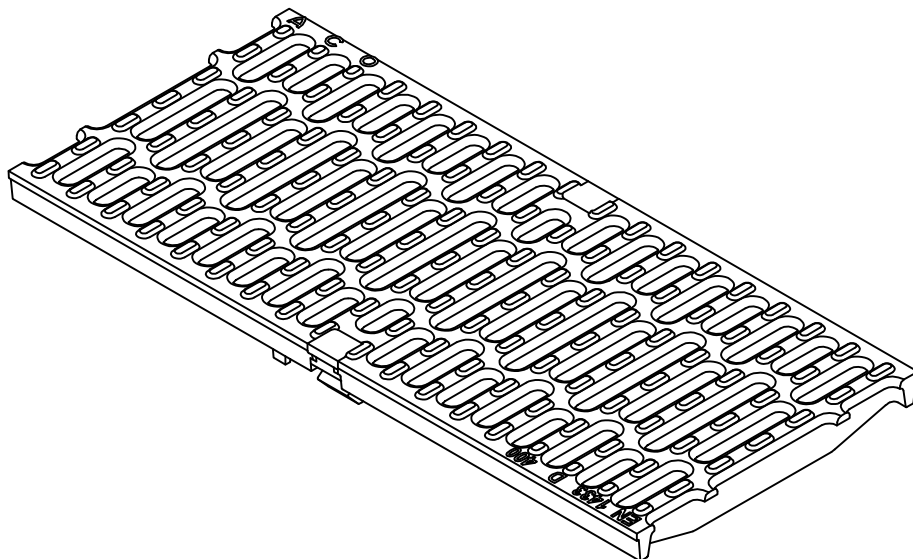
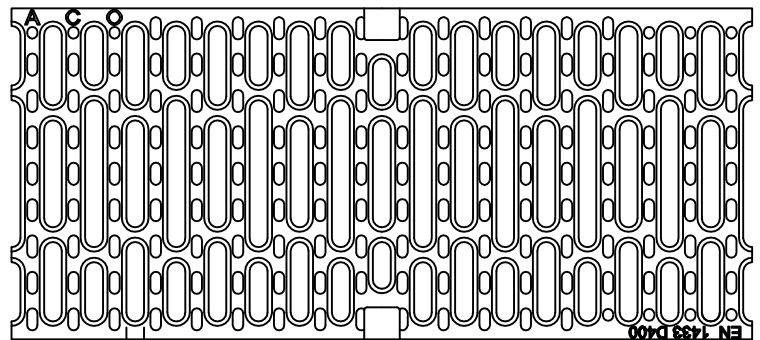
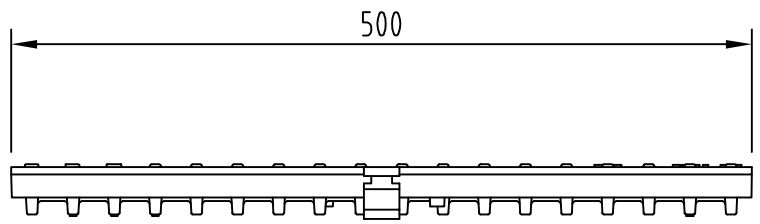
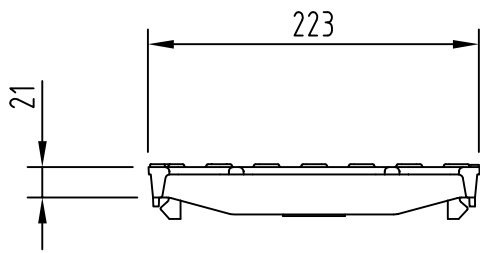

Benennung:  
 ACO DRAIN Multiline V 200 Guss Stegrost EN-GJS  
 L=0,5 m, Kl. D400  
 Art.-Nr. 23224

	Datum	Name
Gez.	05.08.2014	debeling
Upd.	21.01.2015	debeling
Norm		



**ACO Tiefbau**

ACO Tiefbau Vertrieb GmbH  
 24755 Rendsburg, Postfach 320  
 Tel. 04331 / 354-500  
 FAX 04331 / 354-350  
 www.aco-tiefbau.de

Zeichnung-Nr.  
 G1-M01-1471-3

Index  
 000

Technische Änderungen vorbehalten

Schutzvermerk gemäß DIN 34

Ers. für:



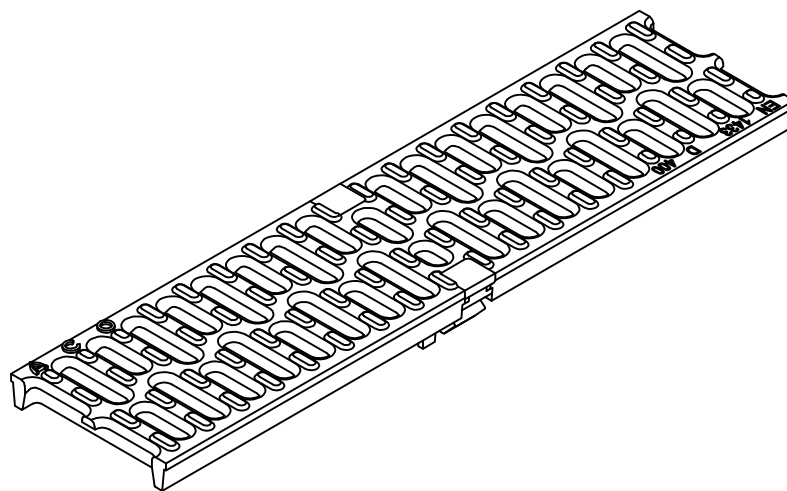
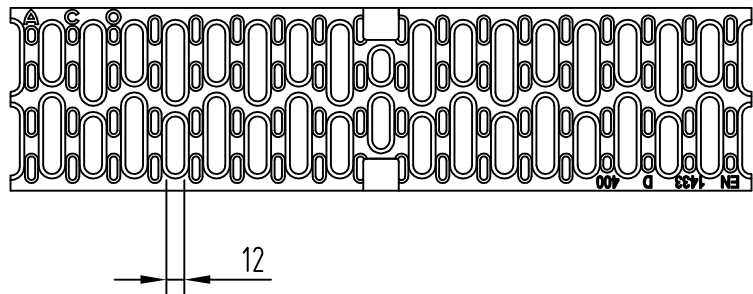
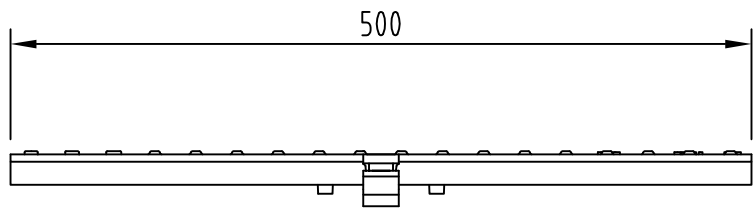
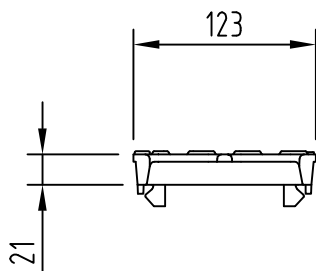

Benennung:  
ACO DRAIN V 100 Guss Stegrost EN-GJS  
L=0,5 m, Kl. D400  
Art.-Nr. 23408

	Datum	Name
Gez.	31.07.2014	debeling
Upd.	21.01.2015	debeling
Norm		



**ACO Tiefbau**

ACO Tiefbau Vertrieb GmbH  
24755 Rendsburg, Postfach 320  
Tel. 04331 / 354-500  
FAX 04331 / 354-350  
www.aco-tiefbau.de

Zeichnung-Nr.  
G1-M01-1469-3

Index  
001

Technische Änderungen vorbehalten

Schutzvermerk gemäß DIN 34

Ers. für:

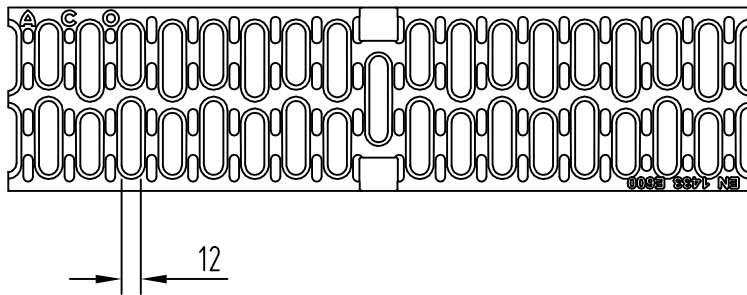
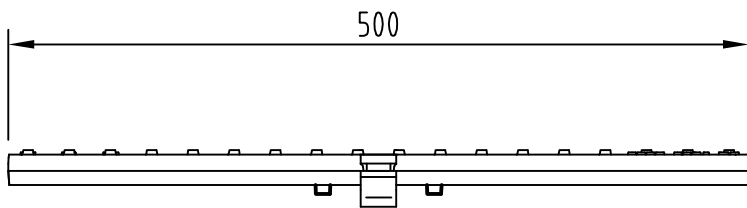
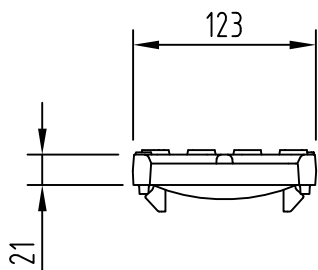

Benennung:  
 ACO DRAIN V 100 Gußstegrost Kl. E600  
 L=0,5 m, aus Kugelgraphitgusseisen  
 Art.-Nr. 132865

	Datum	Name
Gez.	13.03.2007	juitt
Upd.	29.05.2017	debeling
Norm		



**ACO Tiefbau**

ACO Tiefbau Vertrieb GmbH  
 24755 Rendsburg, Postfach 320  
 Tel. 04331/ 354-500  
 FAX 04331/ 354-350  
 www.aco-tiefbau.de

Zeichnung-Nr.  
 G1-M01-950-3

Index  
 003

Technische Änderungen vorbehalten

Schutzvermerk gemäß DIN 34

Ers. für:

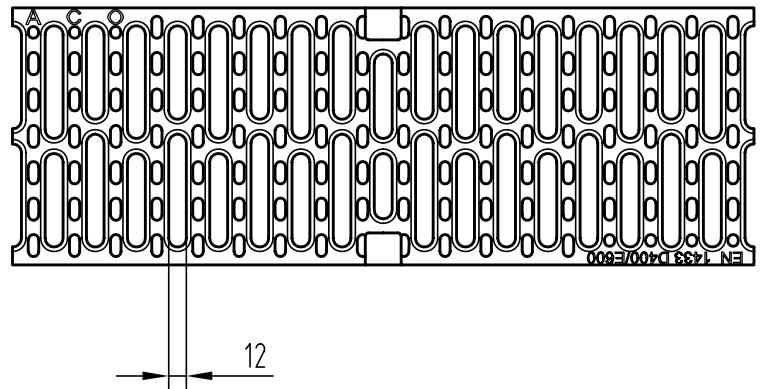
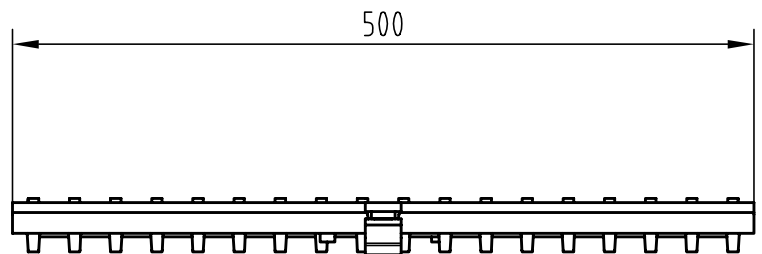
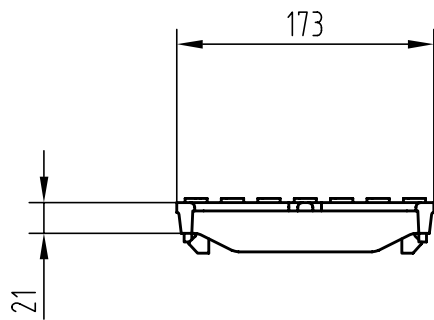

Benennung:  
**ACO DRAIN Multiline V 150 Gußrost Kl.E600**  
 0,5 m  
 Art.-Nr. 13071

	Datum	Name
Gez.	16.09.2004	debeling
Upd.	03.05.2007	debeling
Norm		



**ACO Tiefbau**

**ACO Tiefbau Vertrieb GmbH**  
 24755 Rendsburg, Postfach 328  
 Tel. 04331 / 354-580  
 FAX 04331 / 354-358  
 www.aco-tiefbau.de

Zeichnung-Nr.  
**G1-M01-995-3**

Technische Änderungen vorbehalten

Schutzvermerk gemäß DIN 34

Ers. für:

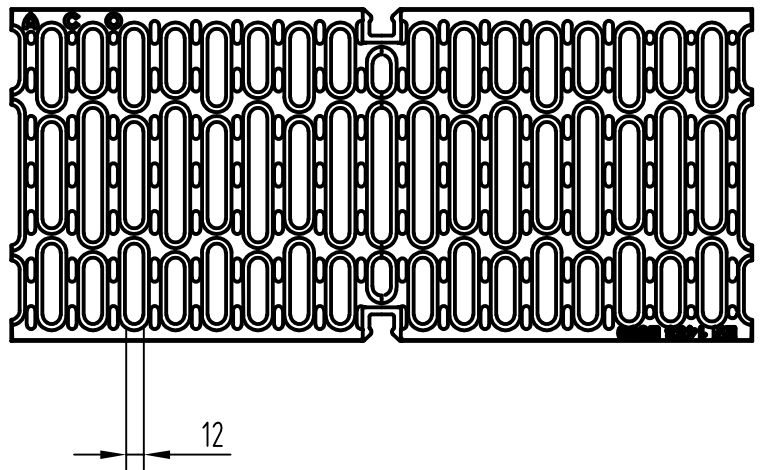
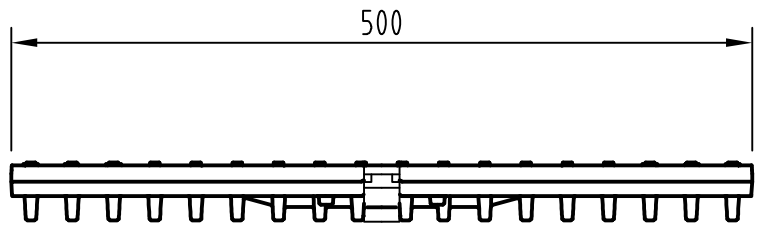
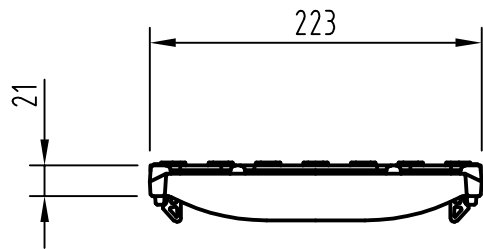

Benennung:  
ACO DRAIN Multiline V 200 Stegrost Kl.E600  
L=0,5 m, aus Kugelgraphitgusseisen  
Art.-Nr. 133666

	Datum	Name
Gez.	01.07.2019	debeling
Upd.		
Norm		



**ACO Tiefbau**

ACO Tiefbau Vertrieb GmbH  
24755 Rendsburg, Postfach 328  
Tel. 04331/ 354-590  
FAX 04331/ 354-358  
www.aco-tiefbau.de

Zeichnung-Nr.

Technische Änderungen vorbehalten

Schutzvermerk gemäß DIN 34

Ers. für: