



Montage-, Bedienungs- und Wartungsanleitung

en	ASSEMBLY, USER AND MAINTENANCE INSTRUCTIONS
fr	NOTICE DE MONTAGE, D'UTILISATION ET D'ENTRETIEN
it	ISTRUZIONI DI MONTAGGIO, USO E MANUTENZIONE
nl	MONTAGE-, BEDIENINGS- EN ONDERHOUDSHANDLEIDING



Infrarotliegekabine

- CLASSIC -



Art.-Nr.: 547.2012.03.00

Infrarotsauna
Kombi-Liegekabine

- CLASSIC KOMBI -

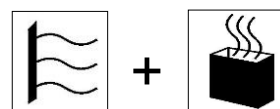

Art.-Nr.: 547.2012.13.00

- de -

Sehr geehrte Kundin, sehr geehrter Kunde,
danke, dass Sie sich für ein weka – Produkt entschieden haben.

Lesen Sie diese Anleitung vor dem Aufbau bitte vollständig durch, um Montagefehler oder Beschädigungen zu vermeiden.

WICHTIG!

Prüfen Sie bitte sofort anhand der Packliste, ob das weka -Produkt vollständig und unbeschädigt bei Ihnen angekommen ist.

Bitte vernichten Sie die Packliste erst nach Ablauf der Garantiezeit. Diese Liste dient Ihnen zur Kontrolle auf Vollständigkeit der Einzelteile und ist mit dem Kaufbeleg aufzubewahren. Eventuelle Beanstandungen können mit Hilfe dieser Liste problemlos behoben werden.

Die Pos.-Nummern der Packliste stimmen nicht mit den Pos.-Nummern folgender Montageanleitung überein. Weiterentwicklungen im Sinne des technischen Fortschritts behalten wir uns vor.

So können geringfügige Abweichungen in den Darstellungen oder Beschreibungen entstehen.

Verpackungsmaterial nicht einfach wegwerfen! Papier-, Pappe- und Wellpappeverpackungen, sowie Kunststoffverpackungsteile sollten in die entsprechenden Sammelbehälter gegeben werden.

Werkstoff Holz

Gesunde Äste, leichte Verfärbungen und kleine Risse sind für Holz charakteristisch, verleihen der Kabine ein natürliches Aussehen und sind kein Reklamationsgrund.

Vor der Montage

Für das Aufstellen der Kabine wird eine **Mindestraumhöhe von 220 cm** benötigt.

Der Wandabstand muss mindestens 10 cm betragen.

Der Fußboden muss eben und waagrecht sein, da es sonst zu Funktionsstörungen kommen kann.

Wir empfehlen Ihnen, die Montage mit zwei Personen durchzuführen.

Zur Verhütung von Unfällen ist zu vermeiden, dass sich Kinder während der Montage in unmittelbarer Nähe befinden.

Zum Aufbau des Kabinenkörpers benötigen Sie rund um die Kabine eine Montagefreiheit von ca. 60 cm.

Tipps zur Sicherheit (547.2012.13.00)

Achten Sie darauf, dass sich keine Kinder unbeaufsichtigt in der Kabine aufhalten!

Legen Sie keine Gegenstände auf dem Saunaofen ab. - **BRANDGEFAHR!**

Vergewissern Sie sich bereits vor Beginn der Heizphase, dass sich keine brennbaren Gegenstände in der Nähe des Ofens befinden.

Verwenden Sie Sauna - Aufgusskonzentrate nur in verdünnter Form. Hinweise über die richtige Handhabung finden Sie auf den Behältern.

Verwenden Sie keine chemischen Klebstoffe im Inneren der Kabine, sondern allenfalls Holzleim.

Nach Nutzung der Sauna lassen Sie diese bei geöffneter Tür auskühlen. Sorgen Sie stets für eine gute Durchlüftung des Raumes, in dem sich die Sauna befindet.

Elektroinstallation (547.2012.13.00)

Die Elektroinstallation darf nur von einem zugelassenen Elektrofachmann unter Beachtung der VDE-und EVU-Richtlinien ausgeführt werden.

Hinweise zur Montage des Saunaofens und des Steuergerätes entnehmen Sie bitte den dort beiliegenden Montageanleitungen.

Nutzungs- und Sicherheitshinweise

Für die Nutzung dieser Infrarotkabine gibt es keine Altersbegrenzung. Prinzipiell kann jeder gesunde Mensch die Infrarotkabine benutzen.

Bei gesundheitlichen Einschränkungen ist vor der Nutzung ein Arzt zu befragen.

Konsultieren Sie ebenfalls Ihren Arzt

- bei Schwangerschaft
- bei Erkrankungen wie Lähmungen, Epilepsie, Bluthochdruck
- wenn Sie Implantatträger sind
- bei Hauterkrankungen, Sensibilitätsstörungen oder nach Behandlungen der Haut
- bei Einnahme von Medikamenten

Nutzen Sie die Infrarotkabine nicht

- bei Fieber oder akuten Infektionen
- Thrombosen, Entzündungen oder offenen Wunden
- bei Stoffwechselkrisen
- unter Alkohol- oder Drogeneinfluss

Kinder, ältere sowie hitzeunempfindliche Menschen oder Behinderte dürfen sich nicht alleine in der Infrarotkabine aufhalten.

Prüfen Sie vor dem Aufheizen, dass sich keine Haustiere in der Kabine aufhalten.

Die Infrarotkabine ist ausschließlich für die Wärmeanwendung vorgesehen. Eine unsachgemäße Nutzung (z.B. zum Wäschetrocknen o.Ä.) ist strengstens verboten.

Da es bei Erstbetrieb zu Geruchsbildung kommen kann, ist die Kabine vor der ersten Nutzung mindestens 1 Stunde lang aufzuheizen und danach gut zu lüften.

Gemäß VDE 0100 dürfen Installationen und Wartung an der Wärmekabine mit elektronischer Steuerung nur von einer Elektrofachkraft durchgeführt werden!

Beim Umgang mit 230V Netzspannung besteht Lebensgefahr!

ACHTUNG - WARNUNG!

Im Bodenelement und in den Wandelementen befinden sich großflächige Heizsysteme mit 230V Netzspannung.

Nach erfolgtem Aufbau der IR – Kabine gemäß Montageanleitung ist das Einbringen von Schrauben, Nägeln, Heftklammern etc. in die Kabinenelemente sowie das teilweise oder ganzflächige Bedecken der Heizflächen (zum Beispiel mit Handtuch, Kissen) strengstens verboten!

BRANDGEFAHR, LEBENSGEFAHR!

Pflegehinweise

Wir empfehlen, in der Kabine auf Saunatüchern zu sitzen, damit der Schweiß nicht auf die Holzteile läuft.

Lassen Sie die Kabine nach jeder Nutzung gut durchlüften.

Sorgen Sie auch für eine gute Durchlüftung des Raumes, in dem sich die Kabine befindet.

Die Heizflächen im Kabineninneren sind wartungsfrei. Sie dürfen nicht abgedeckt oder mit Feuchtigkeit in Berührung kommen. Hartnäckige Schmutzeinwirkungen auf dem Holz können mit Schmirgelpapier entfernt werden.

Geringer Harzausfluss an der Holzoberfläche ist unvermeidbar. Die trockenen Harzrückstände können mit feinem Schleifpapier entfernt werden.

Verwenden Sie keine chemischen Klebstoffe im Inneren der Kabine, sondern allenfalls Holzleim.

Sitzflächen und Bodenrost sollten mindestens einmal halbjährlich außerhalb der Kabine mit einer weichen Bürste und klarem Wasser gründlich gereinigt werden. .

Technische Hinweise

Voraussetzungen zum Anschluss der Infrarotkabine: Eine mit 16A separat abgesicherte Steckdose Bedienung und Anschluss der IR-Steuerung entnehmen Sie bitte der Montageanleitung der Bedienungseinheit und der IR-Steuerung FL.

Der Folienfühler wurde bereits von uns montiert und befindet sich in einem Rückwandelement.

Die Leistung der Glühlampe zur Kabinenbeleuchtung darf maximal 40W betragen!

Achten Sie darauf, dass die Steckdose jederzeit zugänglich sein muss.

Die mitgelieferte Netzanschlussleitung ist im Falle eines späteren Austausches nur über den weka-Kundendienst zu beziehen.

Um das Gerät allpolig vom Netz zu trennen, ist der Netzstecker aus der Steckdose zu ziehen.

Am Leistungsteil befinden sich unter anderem jeweils 2 Buchsen für die Heizkreise 1-3..

Beim Anschluss der Strahlerleitungen ist es ohne Bedeutung, welche der beiden Buchsen genutzt werden.

Um ein Absenken der Glastür vorzubeugen, ziehen Sie die Inbusschrauben der Beschläge fest an.

Türflügel

Die Verstellexzenter Pos. 42 ermöglichen jederzeit auch nachträglich eine einfache Justierung des Glastürblattes. Dazu werden die Innenteile der Türbeschläge abmontiert und die Exzenter in die entsprechende Richtung gedreht.

Bei der Montage der Türgriffe ist darauf zu achten, dass sich das Griffstück aus Metall auf der Außenseite der Tür befindet.

Empfehlungen zum Aufbau

Bohren Sie alle Schraubverbindungen vor, um Beschädigungen an den Holzteilen zu vermeiden! Folgendes Zeichen macht Sie während der Anleitung nochmals darauf aufmerksam:

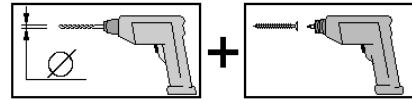

Technische Daten:

- Außenmaße B x T x H: 212 x 121 x 199 cm
- Leistung im Infrarot- Betrieb: 3336 W
- Leistung im Sauna- Betrieb: 3600 W
- Anschluss: 230 V~16A

- Vorheizzeit Infrarot-Betrieb: ca.45 min. bei 20°C Umgebungstemperatur
- Energieverbrauch Infrarot-Betrieb: ca. 2,7 KWh bei 90 min. Anwendungsdauer

- Vorheizzeit Sauna-Betrieb: ca.30 min. bei 20°C Umgebungstemperatur
- Energieverbrauch Sauna-Betrieb: ca. 10,8 KWh bei 4 Stunden. Anwendungsdauer

Werkzeug

Folgendes Werkzeug sollten Sie vor Beginn der Montage zurecht gelegt haben.

Wasserwaage

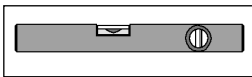

Rollmaß

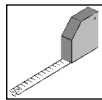

Bohrmaschine

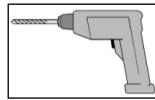

Elektroschrauber

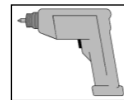

Bleistift

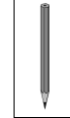

Schraubendreher



Feinsäge / Handkreissäge

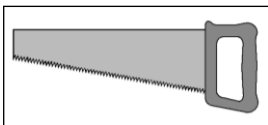

Inbusschlüssel

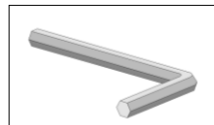

Universalmesser

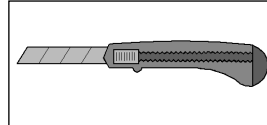

Hammer



Abkürzungen / Symbole:

cm
mm
ca.

Zentimeter
Millimeter
circa



Zuluftöffnung



Abluftöffnung



Aufbauvarianten

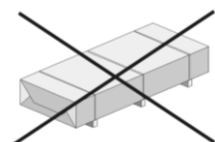

Nicht im Lieferumfang enthalten!

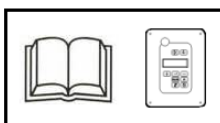

Bedienungsanleitung der IR-Steuerung beachten!

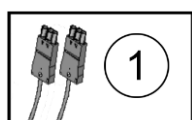

Leitungen von Pos.1 = Bodenelement

Garantiebestimmungen der weka Holzbau GmbH

Wir gewähren Ihnen zu nachfolgenden Konditionen – jedoch nur auf die Holzteile unserer Produkte (weka-Produkt genannt), nicht auf damit verbundene Bauteile oder Bestandteile des weka-Produkts aus anderem Material als Holz – ab Lieferdatum 5 Jahre Garantie auf Funktion. Innerhalb der Garantiezeit werden fehlerhafte Teile oder fehlende Teile der Ware oder die Ware selbst nach unserer Wahl ersetzt. Vom Garantiefumfang erfasst ist lediglich der kostenlose Ersatz des jeweils mangelhaften oder defekten Holzteils. Nicht im Garantiefumfang enthalten sind Folge- oder Zusatzkosten, insbesondere keine Liefer- und Auf- oder Umbaukosten.

Die Garantie ist ausgeschlossen, wenn:

- von der jeweiligen Montageanleitung abgewichen wurde,
- Veränderungen (zusätzliche An- oder Umbauten) an dem Produkt im Vergleich zur Montageanleitung vorgenommen wurden,
- die jeweils angegebenen Belastungsgrenzen (z.B. Schneelast usw.) überschritten wurden,
- das weka-Produkt falsch gegründet (Fundament / Bodenplatte o.Ä.) wurde, insbesondere bei Verstößen gegen die Regeln der Baukunst,
- unterlassene oder nicht ausreichende Pflege (Wartung: Holzschutz, Holzanstrich usw.) des Holzes vorgenommen wurde.
- Windgeschwindigkeiten über Stärke 7, Naturkatastrophen oder gewaltsame Einwirkungen den Schaden am weka-Produkt verursacht haben.
- der Mangel in holztypischen Farbveränderungen, Rissbildungen, Verwerfungen, Schwinden, Quellen oder ähnlichen normalen, in der Natur des Werkstoffes „Holz“ begründeten Veränderungen besteht.

Garantieansprüche können nur in Verbindung mit Originalpackzettel und Originalkaufbeleg in Anspruch genommen werden und müssen innerhalb der Garantiezeit schriftlich, per Telefax oder per e-Mail geltend gemacht werden. Anspruchsvoraussetzung ist eine unverzügliche Anzeige des Mangels bzw. des Schadens in Form einer geordneten Darstellung des Schadens in Bild und Text.

Garantieansprüche sind zu richten an:

weka Holzbau GmbH, Johannesstraße 16, 17034 Neubrandenburg
Fax: 0395/42908-83; e-Mail: info@weka-holzbau.com

Montagebedingungen für weka - Montageteam

Wenn Sie Montagehilfe in Anspruch nehmen und dazu ein weka - Montageteam rufen, wird die weka Holzbau GmbH für Sie wie folgt tätig:

Montage bedeutet das anleitungsgemäße Zusammenfügen (Aufbau) der gelieferten Einzelteile der Ware ohne Anstrich, Lieferung und Montage von Zubehör und Zubehörteilen. Elektrische Anschlüsse sind in den Montageleistungen nicht enthalten.

Die aufzubauende Ware muss sich am Aufbauort/Standort/Standfläche befinden. Transport des Artikels oder der Einzelteile über eine Entfernung von 10-15m hinaus oder in ein anderes Geschoss sind im angebotenen Montagepreis nicht enthalten. Der Untergrund muss tragfähig, horizontal und eben sein. Im Zweifel gilt für die Ebenheit: DIN 18202 „Ebenheitstoleranzen im Hochbau“, Tab.3, Zeile 3, mit einer maximalen Höhendifferenz der am weitesten von einander entfernten Punkten von ca. 10 bis 11mm. Alle vorbereitenden Arbeiten müssen gemäß den technischen Regeln vor Beginn der Montage ausgeführt sein. Die von Ihnen gefertigten oder gewählten Untergründe/Fußböden/Fundamente müssen für die Montage geeignet sein.

- en -

Dear customer

Thank you very much for choosing a weka product.

Read these instructions through completely before assembling your product in order to avoid errors in assembly or damage.

IMPORTANT

Please use the enclosed packing list to check immediately that your weka product has been delivered complete and intact.

Please do not dispose of the packing list before the guarantee period has expired. This list enables you to check that all the individual parts are present. It should be retained along with the proof of purchase. Any complaints which may arise can probably be easily rectified with this list. The item numbers on the packing list do not correspond to the item numbers in the following assembly instructions.

We reserve the right to make further technological developments.

This means that there may be minor deviations in the illustrations.

Please do not simply throw away the packaging material.

Paper, card and corrugated board as well as

plastic packaging materials should be placed in the correct collection containers.

Wood

Healthy knots, light discoloration and small cracks are characteristic of the wood, lending the cabin its natural appearance. They are therefore not grounds for complaint.

Prior to assembly

A minimum room height of 220 cm is required to install the cabin.

The wall clearance should be at least 10 cm.

The floor must be flat and horizontal; otherwise malfunctions may occur.

We recommend that assembly be carried out by two persons.

In order to prevent accidents, we recommend that children be kept out of the direct vicinity during assembly.

When installing the body of the cabin, you need a free area of approx. 60 cm around the cabin in which to work.

Safety tips (547.2012.13.00)

Please note that children should not be permitted unsupervised in the cabin.

Do not place any objects on the sauna furnace – **THERE IS A FIRE RISK!**

Before the heating phase begins, ensure that no flammable objects are located in the vicinity of the furnace. Only use the sauna infusion concentrate in diluted form. Information on correct usage can be found on the containers.

Do not use any chemical adhesives inside the sauna. Only wood glue may be used.

After using the sauna, leave the door open to allow it to cool down. Ensure that the room in which the sauna is located is well ventilated.

Installation of the electrics (547.2012.13.00)

The electrics may only be installed by a qualified electrician in accordance with the VDE and EVU guidelines.

Information on assembly of the sauna furnace and the control device can be found in the enclosed assembly instructions.

Usage and safety information

There is no age restriction for the use of this infrared cabin. In principle, every healthy person can use the infrared cabin.

If a person's health is compromised, a doctor should be consulted before the cabin is used.

Also consult a doctor

- in case of pregnancy
- in case of diseases such as paralysis, epilepsy and high blood pressure
- if you have an implant
- in case of skin diseases and sensitivity disorders or after skin treatments
- when taking medication

Do not use the infrared cabin

- in case of fever or acute infection
- if suffering from thrombosis, infections or open wounds
- if suffering from a metabolic crisis
- under the influence of alcohol or drugs

Children, the elderly and persons not sensitive to heat, as well as handicapped persons, must not be permitted to stay in the infrared cabin by themselves.

Before it is heated up, ensure that there are no pets in the cabin.

The infrared cabin is to be used exclusively for the thermal application. Improper usage (e.g. for drying of laundry or the like) is prohibited under all circumstances.

Since odours may be generated during initial start-up, the cabin must be heated for at least one hour and then well ventilated before being used for the first time.

According to VDE 0100, installation and maintenance of the thermal cabin with electronic controls may only be carried out by a professional electrician.

There is a risk of serious injury or death from exposure to 230 V mains voltage.

WARNING!

Extensive heating systems with 230 V mains voltage are located in the floor and wall elements.

After the infrared cabin has been set up in accordance with the assembly instructions, it is strictly prohibited to install screws, nails, staples and the like in the cabin elements, as well to partially or completely cover the heating surfaces (with towels or pillows, for example).

FIRE HAZARD, RISK OF FATAL INJURY!

Instructions for care

We recommend that you sit on sauna towels in the cabin so that the sweat does not run onto the wood parts. Air out the cabin well after each session.

Also always ensure that the room in which the cabin is located is well ventilated.

The heating surfaces inside the cabin are maintenance free. They should not be covered or allowed to come into contact with moisture. Stubborn stains on the wood can be removed with emery paper.

It is unavoidable that small amounts of resin will appear on the surface of the wood. The dry resin residues can be removed with fine sandpaper.

Always use wood glue, never chemical adhesives, inside the cabin.

The bench and slatted floor should be thoroughly cleaned at least once per year outside of the cabin using a soft brush and clear water.

Technical information

Prerequisite for connecting the infrared cabin: a socket with a separate 16 A fuse

For information on the operation and connection of the IR controller, see the assembly instructions of the control panel and the IR controller.

The film sensor has already been fitted by us and is located in one of the rear wall elements.

The maximum wattage of the bulb used for cabin lighting should not be more than 40 W.

Ensure that the socket is accessible at all times.

If it needs to be replaced at a later date, the included mains cable must be ordered from weka customer service.

In order to ensure all-pole disconnection of the unit from the mains, the plug must be removed from the socket.

Two sockets for heating circuits 1-3 are located on the power element.

When connecting the radiant heater cables, it doesn't matter which of the two sockets is used.

In order to prevent the glass door from sagging, screw down the Allen screw of the fittings tightly.

Door leaf

The adjustable eccentric, item 42, permits easy adjustment of the glass door leaf even at a later point in time.

The internal parts of the door fittings are removed, and the eccentric is rotated in the appropriate direction.

During installation of the door grips, ensure that the metal grip piece is on the outside of the door.

Installation recommendations

Pre-drill all screw connections in order to avoid damaging the wood parts.
The following symbol will remind you to do this in the instructions:

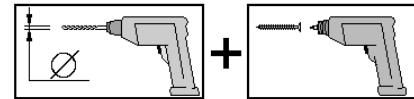

Technical data:

- | | |
|---|---|
| - External dimensions W x D x H : | 212 x 121 x 199 cm |
| - Power in infrared operation: | 3336 W |
| - Power in sauna operation: | 3600 W |
| - Connection : | 230 V~16 A |
|
 | |
| - Pre-heating time infrared operation: | approx. 45 min. at 20°C ambient temperature |
| - Energy consumption infrared operation: | approx. 2.7 KWh for 90 minutes of use |
|
 | |
| - Pre-heating time sauna operation: | approx. 30 min. at 20°C ambient temperature |
| - Energy consumption sauna operation: approx. | 10.8 KWh for 4 hours of use |

Tool

You should have the following tools to hand before beginning assembly:

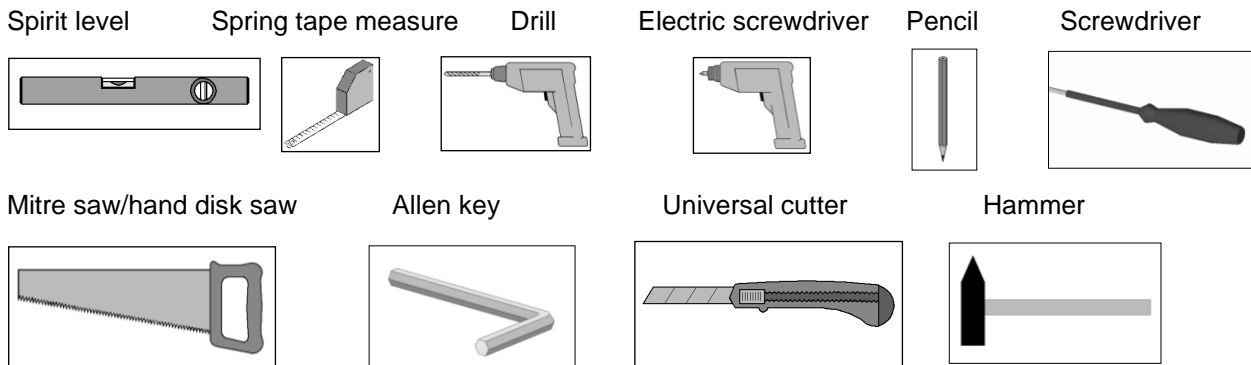

Abbreviations / Symbols

cm	Centimetre
mm	Millimetre
ca.	approximately/approx.



Supply air



Outgoing air



Design variant

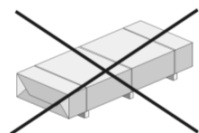

Not included in delivery!

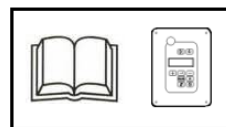

Follow the operating instructions of the IR controller!

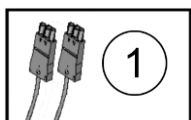

Cable from item 1 = floor element

Warranty terms of weka Holzbau GmbH

We guarantee the function of our products for 5 years from the date of delivery based on the following conditions – however only on the wooden parts of our products (hereinafter weka product) and not on connected components or parts of the weka product made of another material besides wood. Within the warranty period defective parts or missing parts of the product or the product itself will be replaced at our discretion. The warranty extends only to the free-of-charge replacement of the respective faulty or defective wooden part. The warranty does not cover any consequential or additional costs, in particular no delivery and installation or modification costs.

The warranty is void in case of:

- failure to follow the assembly instructions,
- changes (additions or modifications) made to the product diverging from the assembly instructions,
- load limits (e.g. snow load, etc.) having been exceeded,
- the weka product having been installed on an incorrect foundation or floor plate, etc., in particular in case of violation of the rules of architecture,
- lack of or insufficient care of the wood (maintenance measures such as preservation or painting of the wood),
- wind speeds stronger than force 7 (moderate gales), natural catastrophes or brute force having caused the damage to the weka product,
- the deficiency consisting in changes which are typical for wood, such as discoloration, formation of cracks, warping, shrinking, swelling or similar normal effects on the material "wood".

Warranty claims must be accompanied by the original packing slip and the original sales receipt and must be submitted within the warranty period in writing or by fax or e-mail. A further prerequisite for a claim is the immediate notification of the defect or damage in the form of pictures and a written description of the defect.

Address all warranty claims to:

weka Holzbau GmbH, Johannesstraße 16, 17034 Neubrandenburg
Fax: 0395/42908-83; E-mail: info@weka-holzbau.com

Assembly conditions for a weka assembly team

If you wish for help assembling your cabin and choose to employ a weka assembly team, weka Holzbau GmbH will carry out the following services for you:

Assembly means putting together (installation) of the individual parts supplied. It does not include treating them with a wood protection agent, the delivery and assembly of accessories and accessory parts. Electrical connections are not included in the assembly service.

The items to be assembled must be located at the installation site/location/base area. Transport of the article or the individual parts over a distance greater than 10-15m or to another level is not included in the assembly price quoted. The substrate must be stable, horizontal and level.

In the event of doubt, reference should be made to DIN 18202 'Level tolerances in building construction', tab. 3, row 3, with a maximum height difference at the furthest points of approx. 10 to 11 mm.

All preparatory work must have been carried out in accordance with the technical regulations before assembly begins. The substrates/floors/foundations constructed or selected by you must be suitable for the assembly.

- fr -

Chère Cliente, cher Client

Nous vous remercions d'avoir choisi un produit weka.

Lisez entièrement la présente notice avant de procéder à l'assemblage afin d'éviter les erreurs et les dommages.

IMPORTANT !

Veuillez vérifier immédiatement, à l'aide de la liste des pièces, si le produit weka est arrivé complet et en bon état.

Ne détruisez la liste des pièces qu'une fois la garantie écoulee. Cette liste vous permet de vérifier si les pièces détachées sont complètes et doit être conservée avec le justificatif d'achat. Elle vous permettra de faire valoir aisément d'éventuelles réclamations. Les numéros de pos. de la liste des pièces ne sont pas identiques aux numéros de pos. de la présente notice de montage.

Nous nous réservons le droit d'apporter aux produits des modifications dans le cadre de l'évolution technique.

De légères différences sont par conséquent possibles par rapport aux illustrations.

Ne pas jeter simplement le matériel d'emballage! Les emballages en papier, carton et carton ondulé doivent être déposés dans le container de tri correspondant.

Le bois

Les noeuds robustes, les légères décolorations et les petites fissures sont typiques du bois, confèrent aux cabines leur aspect naturel et ne constituent pas un motif de réclamation.

Préalablement au montage

Pour mettre en place la cabine, vous devez disposer d'une **hauteur de plafond minimum de 220 cm**.

La distance aux murs doit être d'au moins 10 cm.

Le sol doit être plat et parfaitement horizontal, sous peine dans le cas contraire de perturber le fonctionnement de la cabine.

Nous vous recommandons d'effectuer le montage à deux.

Pour prévenir les accidents, faites en sorte que les enfants ne se situent pas à proximité durant le montage. Prévoyez pour le montage un espace libre d'env. 60 cm autour de la cabine.

Conseils de sécurité (547.2012.13.00)

Veillez à ce que les enfants ne restent pas dans la cabine sans surveillance !

Ne déposez pas d'objets sur le four du sauna. - **DANGER D'INCENDIE !**

Assurez-vous, dès le début de la phase de chauffe, qu'aucun objet inflammable ne se trouve à proximité du four.

N'utilisez les concentrés pour sauna que sous forme diluée. Les informations nécessaires pour leur bonne utilisation figurent sur les récipients.

N'utilisez pas de colles chimiques à l'intérieur du sauna mais tout au plus de la colle à bois.

Après l'utilisation, laissez le sauna refroidir avec la porte ouverte. La pièce dans laquelle se trouve le sauna doit toujours être bien aérée.

Installation électrique (547.2012.13.00)

L'installation électrique doit être effectuée uniquement par un électricien agréé, en respect des normes de l'union des électriciens allemands VDE et de l'entreprise de fourniture d'électricité.

Pour les informations relatives au montage du four du sauna et de l'unité de commande, veuillez vous référer aux notices de montage correspondantes.

Consignes d'utilisation et de sécurité

Il n'existe pas de limite d'âge concernant l'utilisation de cette cabine à infrarouge. En principe, toutes les personnes en bonne santé peuvent s'en servir.

En cas de problèmes de santé, il convient de demander l'avis d'un médecin avant toute utilisation.

Consultez également votre médecin

- en cas de grossesse
- en cas de paralysie ou si vous souffrez d'hypertension artérielle et d'épilepsie
- si vous avez des implants
- en cas d'affections de la peau, de troubles de la sensibilité ou après des traitements cutanés
- en cas de prise de médicaments

N'utilisez pas la cabine à infrarouge

- en cas de fièvre ou d'infections aiguës
- en cas de thromboses, d'inflammations ou de plaies ouvertes
- en cas de crises métaboliques
- sous l'influence de l'alcool ou de la drogue

Il est interdit aux enfants, aux personnes d'un certain âge, aux personnes insensibles à la chaleur et à celles souffrant d'un handicap de rester seuls dans la cabine à infrarouge.

Avant de la faire chauffer, vérifiez qu'aucun de vos animaux ne s'y trouve.

La cabine à infrarouge est exclusivement prévue pour l'utilisation de chaleur. Une utilisation non conforme (par ex. pour sécher du linge etc.) est formellement interdite.

Du fait de l'apparition possible d'odeurs pouvant lors de la mise en service, il est recommandé de faire chauffer la cabine pendant au moins 1 heure puis de bien l'aérer avant la première utilisation.

Conformément à la norme VDE 0100, les travaux d'installation et de maintenance de la cabine thermique à commande électronique doivent être effectués exclusivement par un électricien.

Une erreur de manipulation à une tension d'alimentation de 230 V est synonyme de danger de mort !

ATTENTION !

De larges systèmes de chauffage fonctionnant à une tension d'alimentation de 230 V se trouvent dans l'élément de sol et dans les éléments de paroi.

Une fois la cabine IR – conformément à la notice de montage – assemblée, il est formellement interdit de fixer des vis, clous, agrafes, etc. dans les éléments de la cabine ainsi que de recouvrir en partie ou intégralement les surfaces de chauffage (par exemple avec des serviettes de bain, des coussins) !

RISQUE D'INCENDIE, DANGER DE MORT !

Entretien

Nous recommandons d'utiliser des serviettes de sauna pour s'asseoir dans la cabine afin d'éviter que la transpiration ne coule sur les éléments en bois.

Aérez intégralement la cabine après chaque utilisation.

Veillez aussi à bien aérer la pièce dans laquelle vous avez installé la cabine à infrarouge.

Les surfaces de chauffage à l'intérieur de la cabine ne nécessitent pas d'entretien particulier. Elles ne doivent pas être recouvertes ou entrer en contact avec l'humidité. Vous pouvez éliminer les saletés les plus tenaces en frottant le bois avec du papier émeri.

De faibles coulures de résine à la surface du bois sont inévitables. Les résidus de résine séchés peuvent être retirés à l'aide d'un papier émeri fin.

N'utilisez aucune colle chimique à l'intérieur de la cabine, uniquement de la colle à bois.

La banquette et le caillebotis de sol doivent être sortis de la cabine pour être intégralement nettoyés avec une brosse souple et de l'eau claire, au moins une fois tous les six mois.

Consignes techniques

Conditions nécessaires au branchement de la cabine infrarouge : une prise électrique protégée par fusible distinct 16A

Reportez-vous à la notice de montage de l'unité de commande et de la commande IR pour le fonctionnement et le raccordement de la commande IR.

Le capteur en film a été monté en usine et se trouve dans l'un des éléments de la paroi arrière.

L'ampoule utilisée pour l'éclairage de la cabine ne doit pas dépasser une puissance de 40 W !

Veillez à ce que la prise soit accessible à tout moment.

Le câble d'alimentation fourni ne peut être obtenu, dans le cas d'un échange ultérieur, qu'auprès de notre service clientèle weka.

Afin de couper l'alimentation de l'appareil sur tous les pôles, il est nécessaire de retirer la fiche secteur de la prise électrique.

Sur le bloc secteur se trouvent, entre autres, 2 prises pour les circuits de chauffage 1-3..

Lors du raccordement des câbles des radiateurs, vous pouvez utiliser indifféremment l'une ou l'autre des deux prises.

Afin d'éviter un éventuel affaissement de la porte, serrez solidement les vis à six pans creux des ferrures.

Battant de porte

Les excentriques de positionnement, pos. 42, permettent d'ajuster simplement et à tout moment, même a posteriori, le panneau mobile de la porte vitrée. Pour cela, les parties intérieures des ferrures sont démontées et les excentriques tournés dans la direction désirée.

Lors du montage des poignées de porte, bien veiller à ce que la pièce de préhension en métal soit positionnée sur le côté extérieur de la porte.

Recommandations en vue de l'assemblage

Pré-percez tous les assemblages vissés afin d'éviter d'endommager les éléments en bois ! Ceci vous est rappelé par le symbole suivant dans la notice :

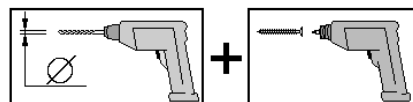

Caractéristiques techniques :

- | | |
|---|---|
| - Dimensions extérieures L x P x H : | 212 x 121 x 199 cm |
| - Puissance en fonctionnement infrarouge : | 3336 W |
| - Puissance en fonctionnement sauna : | 3600 W |
| - Raccordement : | 230 V~16A |
| - Temps de préchauffage en fonctionnement infrarouge : | env. 45 min. pour une température ambiante de 20°C. |
| - Consommation d'énergie en fonctionnement infrarouge : | env. 2,7 kWh pour une durée d'utilisation de 90 min. |
| - Temps de préchauffage en fonctionnement sauna : | env. 30 min. pour une température ambiante de 20°C. |
| - Consommation d'énergie en fonctionnement sauna : | env. 10,8 kWh pour une durée d'utilisation de 4 heures. Durée d'utilisation |

Outil

Pour le montage, nous vous recommandons de préparer les outils suivants :

Niveau à bulle

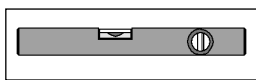

décimètre à ruban

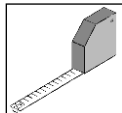

perceuse

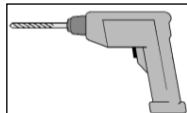

visseuse électrique

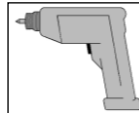

Tournevis

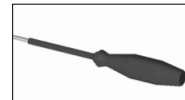

scie à denture fine / scie circulaire

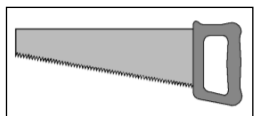

clé pour vis à six pans creux

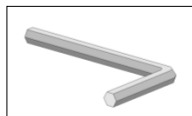

couteau universel

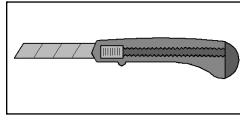

marteau crayon



Abréviations / Symboles :

cm
mm
ca.

centimètres
millimètres
environ / env.

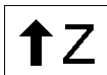

air amené



air sortant



variante de montage

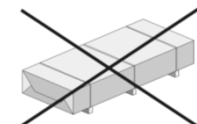

Non compris dans la livraison!

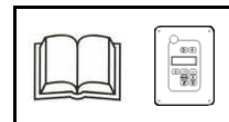

Respecter la notice d'utilisation de la commande IR !

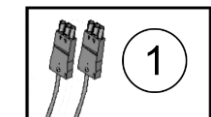

Câble de rep.1 = élément de sol

Conditions de garantie de la weka Holzbau GmbH

Nous vous accordons, aux conditions qui suivent, 5 ans de garantie à compter de la date de livraison sur le bon fonctionnement des pièces en bois de nos produits exclusivement (désignés produits weka), à l'exclusion des pièces qui leur sont associées et à l'exclusion des composants du produit weka fabriqués en un matériau autre que le bois. Pendant la durée de la garantie, les pièces défectueuses, ou les pièces de la marchandise manquantes ou la marchandise elle-même seront remplacées suivant notre choix. L'étendue de la garantie se limite au remplacement gratuit de la pièce en bois défectueuse ou comportant un vice. Sont exclus de l'étendue de la garantie les coûts consécutifs ou supplémentaires et singulièrement les coûts de livraison, de montage ou de transformation.

La garantie est exclue dans les cas suivants :

- La notice de montage n'a pas été respectée,
- Le produit a été modifié (par des pièces rapportées ou des transformations) par rapport à ce qui est dit dans la notice de montage,
- Les limites de charge indiquées (par exemple le poids de la neige etc) ont été dépassées,
- Le produit weka a été monté sur des mauvaises fondations (dalle, plancher ou autre) et notamment en cas de non respect des règles de construction,
- L'entretien du bois a été négligé ou est insuffisant (entretien : protection du bois, peinture, etc.).
- Le vent de force supérieure à 7, les catastrophes naturelles ou des manifestations de violence ont endommagé le produit weka.
- Le défaut consiste en des modifications inhérentes à la nature du matériau « bois », comme par exemple les changements de couleur caractéristiques pour le bois, les fissures, le gauchissement, le rétrécissement, ou le gonflement ou autres.

Le recours à la garantie ne peut se faire qu'avec le bordereau de colisage d'origine et le document d'achat d'origine pendant la période de garantie par écrit, par fax ou par courriel. Il est subordonné à la dénonciation immédiate du vice ou du défaut sous forme d'une description explicite du dommage par le texte et l'image.

Le recours à la garantie sera adressé à :

weka Holzbau GmbH, Johannesstrasse 16, 17034 Neubrandenburg
Télécopie : 0395/42908-83; e-Mail : info@weka-holzbau.com

Conditions de montage pour l'équipe de montage weka

Si vous décidez de vous faire aider pour le montage et que vous faites appel à l'équipe de montage weka, weka Holzbau GmbH prendra en charge les éléments suivants à votre place :

Le montage, ce qui signifie l'assemblage conforme aux instructions (montage) des pièces détachées livrées pour la marchandise sans application de produit, la livraison et le montage des accessoires. Les raccordements électriques ne sont pas compris dans les prestations de montage.

La marchandise à installer doit se trouver sur le lieu de montage/d'implantation/de pose. Le transport de l'article ou des pièces détachées à une distance de plus de 5 m ou à un autre étage n'est pas compris dans le prix du montage. Le sous-sol doit être solide, horizontal et plan.

En cas de doute sur la planéité, voir : DIN 18202 "Toleranzen im Hochbau" (Tolérances pour les constructions), tableau 3, ligne 3, avec une différence de hauteur maximale entre les points les plus éloignés de 10 à 11 mm.

Tous les travaux préparatoires doivent avoir été faits avant le montage conformément aux règles de l'art. Les sous-sols/planchers/fondations réalisés par vous-même doivent être appropriés pour le montage.

- it -

Egregi clienti,
ci congratuliamo con voi per avere scelto un prodotto weka.

Prima del montaggio leggete con cura le presenti istruzioni al fine di evitare errori di montaggio o danni.

IMPORTANTE !

Controllate subito con l'ausilio della lista di imballaggio che il prodotto weka sia stato fornito completo e senza danni.

Vi preghiamo di conservare la lista di imballaggio solo alla scadenza del periodo di garanzia. Questa lista serve per controllare la completezza della fornitura e deve essere conservata insieme allo scontrino. Con l'ausilio della lista è possibile risolvere eventuali reclami. I numeri di posizione della lista di imballaggio non corrispondono con i numeri di posizione delle seguenti istruzioni di montaggio.

Ci riserviamo di apportare modifiche ai fini del progresso tecnologico. Per tale motivo è possibile che nelle rappresentazioni vengano a crearsi lievi differenze.

Non gettare via il materiale di imballaggio! La carta, il cartone normale e ondulato cosiccome gli imballaggi in plastica devono essere smaltiti negli appositi contenitori di raccolta.

Il legno come materiale

Questo legno di abete rosso è caratterizzato da nodi sani, lievi scolorimenti e piccole incrinature, che donano alla cabina il suo aspetto naturale e che non costituiscono alcun motivo di reclamo.

Prima del montaggio

Per l'installazione della cabina è necessaria un'**altezza dell'ambiente minima di 220 cm**.

La distanza delle pareti deve essere di almeno 10 cm.

Il pavimento deve essere piano e ben livellato; in caso contrario non sono da escludere anomalie di funzionamento.

Raccomandiamo di eseguire le operazioni di montaggio sempre in due.

Per la prevenzione di infortuni è necessario evitare la presenza di bambini nelle immediate vicinanze dei lavori di montaggio.

Per il montaggio del corpo della cabina occorre disporre di una libertà di montaggio di circa 60 cm intorno alla cabina stessa.

Suggerimenti per la sicurezza (547.2012.13.00)

Assicurarsi che i bambini non sostino nella cabina senza sorveglianza!

Non appoggiate nessun oggetto sul forno della sauna. - **PERICOLO DI INCENDIO !**

Assicuratevi già prima di iniziare a riscaldare che nelle vicinanze del forno non si trovino oggetti infiammabili. Utilizzate esclusivamente concentrati per sauna diluiti. Delle indicazioni sull'uso corretto sono riportate sui contenitori.

All'interno della sauna non utilizzare collanti chimici, al massimo collante per legno.

Fate in modo di aerare bene anche la stanza in cui si trova la sauna.

Installazione elettrica (547.2012.13.00)

L'installazione elettrica deve essere eseguita esclusivamente da personale elettrico qualificato e autorizzato in pieno rispetto delle direttive VDE e EVU.

Per indicazioni sul montaggio del forno per sauna e della centralina consultare le istruzioni di montaggio fornite.

Avvertenze sull'uso e sulla sicurezza

Per l'utilizzo di questa cabina a raggi infrarossi non ci sono limiti di età; in linea di principio può essere utilizzata da tutte le persone sane.

Prima dell'utilizzo è necessario consultare un medico in caso di problemi di salute.

Rivolgersi inoltre ad un medico

- in caso di gravidanza
- in caso di malattie, quali paralisi, epilessia, ipertensione
- se si è stati sottoposti ad impianti
- in caso di malattie cutanee, perdita di sensibilità oppure in seguito a trattamenti cutanei
- in caso di assunzione di farmaci

Non utilizzare la cabina a raggi infrarossi

- in caso di febbre o infezioni acute
- in presenza di trombosi, infiammazioni o ferite aperte
- in caso di crisi metaboliche
- sotto l'effetto di alcool o droghe.

Bambini, anziani e persone sensibili al calore o diversamente abili non devono restare soli nella cabina a raggi infrarossi. Prima del riscaldamento controllare che non ci siano animali domestici in cabina.

La cabina a raggi infrarossi è concepita esclusivamente per l'utilizzo del calore. È severamente proibito qualsiasi utilizzo non appropriato (ad es. per asciugare la biancheria, ecc.). Poiché in occasione della messa in esercizio può svilupparsi odore, prima del primo utilizzo la cabina deve essere riscaldata per 1 ora, poi ben areata.

Conformemente alla norma VDE 0100, gli interventi di installazione e di manutenzione sulla cabina termica con comando elettronico possono essere realizzati esclusivamente da elettricisti specializzati. Pericolo di morte in caso di contatto con la tensione di rete da 230 V!

AVVERTENZA!

Nell'elemento pavimento e negli elementi parete si trovano sistemi riscaldanti di grandi dimensioni con tensione di rete da 230 V.

Dopo il montaggio della cabina a raggi infrarossi in base alle istruzioni, è rigorosamente vietato applicare sugli elementi della cabina viti, chiodi, punti metallici, ecc. e coprire parzialmente o totalmente le superfici riscaldanti (ad esempio con asciugamani, cuscini)!

PERICOLO DI INCENDIO, PERICOLO DI MORTE!

Avvertenze per la manutenzione

All'interno della cabina è consigliabile sedersi su asciugamani per saune, per evitare che il sudore si depositi sul legno.

Dopo ogni utilizzo, ventilare opportunamente la cabina.

Fare in modo che anche l'ambiente in cui si trova la cabina a raggi infrarossi sia ben ventilato.

Le superfici riscaldanti presenti all'interno della cabina sono esenti da manutenzione. Non devono essere coperte o entrare in contatto con l'umidità. Lo sporco ostinato che agisce sul legno può essere rimosso con carta abrasiva.

È comunque inevitabile un lieve efflusso di resina dalla superficie del legno. I residui di resina essiccata possono però essere eliminati con della carta abrasiva fine.

Non utilizzare in nessun caso collanti chimici all'interno della cabina, bensì esclusivamente collanti per legno.

Panche e griglie pavimento devono essere pulite almeno una volta ogni sei mesi all'esterno della cabina con una spazzola morbida, quindi sciacquate a fondo con acqua.

Avvertenze tecniche

Presupposti per il collegamento della cabina a raggi infrarossi: presa protetta separatamente con un fusibile da 16 A.

Per informazioni sull'uso e il collegamento del comando IR, consultare le istruzioni di montaggio dell'unità di comando e del comando IR.

Il sensore a membrana è già stato montato in fabbrica e si trova in uno degli elementi della parete posteriore.

La potenza della lampadina per l'illuminazione della cabina deve essere di max. 40 W!

Fare in modo che la presa sia accessibile in qualsiasi momento.

Il cavo di allacciamento alla rete in dotazione, in caso di sostituzione deve essere acquistato solo tramite il servizio clienti weka.

Per staccare l'apparecchio dalla rete scollegando tutti i poli, estrarre il connettore di rete dalla presa.

Sulla parte di potenza si trovano tra le altre cose 2 prese per i circuiti di riscaldamento 1-3.

Durante l'allacciamento dei cavi dei radiatori, non ha importanza quale dei due jack viene utilizzato.

Per evitare un abbassamento della porta in vetro, stringere a fondo le viti a esagono cavo delle bandelle.

Battente della porta

Gli eccentrici di regolazione (pos. 42) consentono di regolare facilmente e in qualsiasi momento, anche a posteriori, l'anta della porta di vetro. A tale scopo le parti interne delle cerniere della porta vengono smontate e gli eccentrici ruotati nella direzione corrispondente.

In fase di montaggio delle maniglie accertarsi che il pezzo in metallo della maniglia si trovi sul lato esterno della porta.

Suggerimenti per il montaggio

Per evitare danni agli elementi in legno, si raccomanda di pre-forare tutti i punti di collegamento a vite! Il presente simbolo richiama l'attenzione su tale particolare nel corso delle istruzioni:

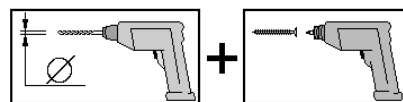

Dati tecnici:

- dimensioni esterne, larg. X prof. X alt.: 212 x 121 x 199 cm
- potenza nel modo a raggi infrarossi: 3336 W
- potenza nel modo sauna: 3600 W
- collegamento: 230 V~16A

- tempo di preriscaldamento nel modo a raggi infrarossi: ca. 45 min. ad una temperatura ambiente di 20°C
- consumo energetico nel modo a raggi infrarossi: ca. 2,7 KWh in caso di durata d'impiego di 90 min.

- tempo di preriscaldamento nel modo sauna: ca. 30 min. ad una temperatura ambiente di 20°C
- consumo energetico nel modo sauna: ca. 10,8 KWh in caso di durata d'impiego di 4 ore

utensile

Prima di iniziare con il montaggio tenere a portata di mano i seguenti utensili:

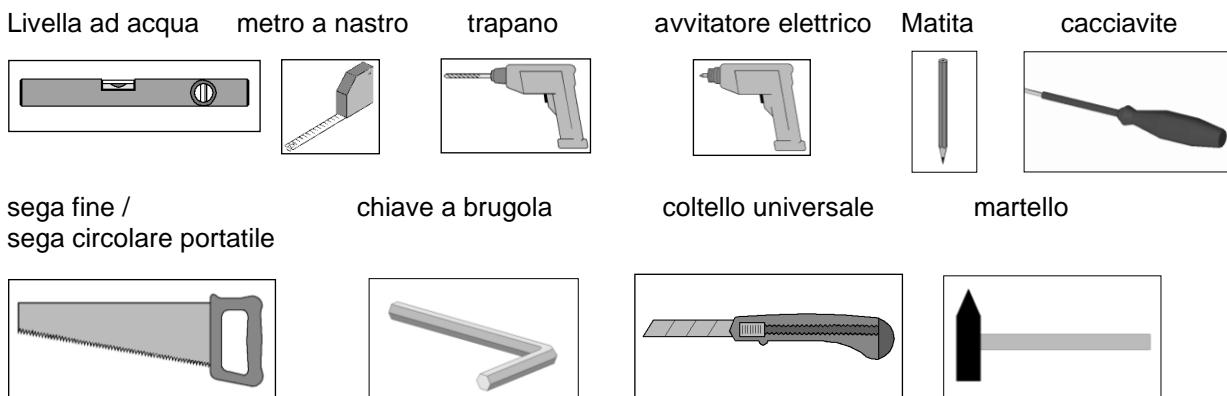

Abbreviazioni / Simboli

cm Centrimetri
 mm Millimetri
 ca. circa / ca.

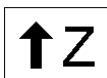

Aerazione



Scarico



variante costruttiva

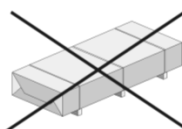

Non compreso nella fornitura!

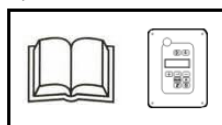

rispettare le istruzioni per l'uso del comando IR!

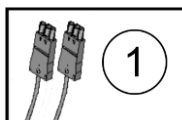

cavo da pos. 1 = elemento pavimento

Condizioni di garanzia di weka Holzbau GmbH

Concediamo alle seguenti condizioni – tuttavia soltanto sulle parti in legno dei nostri prodotti (qui di seguito designate prodotto weka), non sui componenti o gli elementi del prodotto weka a queste collegati – una garanzia di funzionalità di 5 anni dalla data di consegna. Per tutta la durata della garanzia sostituiamo, a nostra discrezione, le parti difettose o mancanti della merce o la merce stessa. La portata della garanzia comprende esclusivamente la sostituzione gratuita della parte in legno guasta o difettosa. La garanzia non copre invece i costi conseguenti o aggiuntivi, in particolare le spese di consegna, installazione e modifica.

La garanzia è esclusa se:

- non ci si è attenuti alle istruzioni per il montaggio,
- sono state apportate modifiche (aggiunte o cambiamenti) al prodotto rispetto alle istruzioni per il montaggio,
- sono stati superati i limiti di sollecitazione indicati (ad es. carico da neve ecc.),
- le fondazioni del prodotto weka sono state realizzate in maniera non corretta (fondamenta / piastra base o similare), in particolare se sono state violate le regole dell'architettura,
- il legno non è stato curato o è stato curato in misura insufficiente (manutenzione: protettivo o vernice per legno ecc.),
- velocità del vento superiori a forza 7, catastrofi naturali o azioni violente che hanno causato il danno al prodotto weka,
- il difetto consiste in alterazioni cromatiche, crepe, imbarcamenti, ritiri, rigonfiamenti o simili modificazioni che sono normali, in quanto legate alla natura del materiale „legno“.

I diritti di garanzia possono essere fatti valere soltanto unitamente alla distinta di imballo originale e al giustificativo d'acquisto originale e devono essere rivendicati per iscritto oppure mediante fax o e-mail entro la durata della garanzia. Premessa per la rivendicazione è la tempestiva segnalazione del difetto o del danno sotto forma di rappresentazione ordinata dello stesso tramite testo e figure.

Le richieste di garanzia devono essere rivolte a:

weka Holzbau GmbH, Johannesstraße 16, 17034 Neubrandenburg
Fax: 0395/42908-83; e-mail: info@weka-holzbau.com

Condizioni di montaggio per weka – squadra di montaggio

Se avete bisogno di aiuto per il montaggio e chiamate perciò una squadra di montaggio weka, weka Holzbau GmbH interverrà alle seguenti condizioni:

Per montaggio si intende l'assemblaggio conforme alle istruzioni (installazione) dei singoli componenti forniti senza verniciatura, consegna e montaggio di accessori o parti di accessori. L'allacciamento elettrico non è compreso nel montaggio.

I pezzi da montare devono trovarsi sul luogo/superficie/terreno di montaggio. Il trasporto dell'articolo o del componente singolo per oltre 10-155m all'aperto o su un altro piano non è incluso nel prezzo di montaggio. La base di appoggio deve essere stabile, orizzontale e piana.

In caso di dubbio spianare il terreno in case a: DIN 18202 "Tolleranze di planarità nell'edilizia", tab.3, riga 3, con una differenza massima di livello tra i due punti più lontani da ca. 10 a 11mm.

Tutti i lavori preparatori devono essere eseguiti allo stato dell'arte prima dell'inizio del montaggio. I sottofondi/pavimenti/le fondamenta che avete preparato o scelto devono essere idonei per il montaggio.

- nl -

Geachte klant,

Wij zijn u erkentelijk dat u voor een product van weka hebt gekozen.

Lees deze handleiding vóór de montage helemaal om montagefouten of schade te vermijden.

BELANGRIJK!

Gelieve onmiddellijk aan de hand van de paklijst te controleren of het weka-product volledig en onbeschadigd bij u aangekomen is.

Vernietig de paklijst pas na afloop van de garantieperiode. Deze lijst is voor de controle op volledigheid van alle onderdelen en moet met de kassabon worden bewaard. Eventuele reclames kunnen met behulp van deze lijst probleemloos worden opgelost.

De pos.-nummers van de paklijst komen niet overeen met de pos.-nummers van de volgende montagehandleiding.

Ontwikkelingen ten behoeve van technische vooruitgang behouden wij ons voor.

Op deze wijze kunnen kleine afwijkingen in de afbeeldingen of beschrijvingen ontstaan.

Verpakkingsmateriaal niet zomaar weggooiën! Papier-, karton- of golfkartonverpakkingen alsook kunststofverpakkingsdelen moeten in de betreffende verzamelcontainer worden gedeponeerd.

Materiaal hout

Normale knoesten, kleine scheurtjes en lichte verkleuring zijn voor hout kenmerkend, geven de cabine een natuurlijk uiterlijk en zijn geen reden voor reclames.

Vóór de montage

Voor het plaatsen van de cabine is een **minimumhoogte van 220 cm** nodig.

De afstand tot de wand moet minstens 10 cm bedragen.

De vloer moet vlak en horizontaal zijn, omdat anders functiestoringen kunnen optreden.

Wij adviseren de montage met twee personen uit te voeren.

Om ongevallen te voorkomen, moet worden vermeden dat kinderen zich tijdens de montage in de directe nabijheid bevinden.

Om de cabine in elkaar te zetten hebt u ongeveer 60 cm vrije ruimte rond de cabine nodig.

Tips voor de veiligheid (547.2012.13.00)

Zorg ervoor dat kinderen alleen onder toezicht in de cabine verblijven!

Leg geen voorwerpen op de saunaoven. - **BRANDGEVAAR !**

Overtuig u ervan, dat er vóór het begin van de verwarmingsfase zich geen brandbare voorwerpen in de buurt van de oven bevinden.

Gebruik sauna- en gietconcentraat uitsluitend in verdunde vorm. Aanwijzingen over het juiste gebruik vindt u op de verpakking.

Gebruik geen chemische lijm in de cabine, maar eventueel houtlijm.

Na gebruik van de sauna laat u deze bij geopende deur afkoelen. Zorg steeds voor een goede ventilatie van de ruimte waarin de sauna zich bevindt.

Elektrische installatie (547.2012.13.00)

De elektrische installatie mag uitsluitend door een erkend elektrotechnisch vakman met inachtneming van de VDE- en EVU-richtlijnen uitgevoerd worden.

Aanwijzingen voor de montage van de saunaoven en het bedieningsapparaat vindt u in de meegeleverde montagehandleidingen.

Gebruiks- en veiligheidsvoorschriften

Voor het gebruik van deze infraroodcabine is er geen leeftijdsbeperking. Principieel kan elke gezonde mens de infraroodcabine gebruiken.

Bij beperkingen op het vlak van de gezondheid moet vóór gebruik een arts geconsulteerd worden:

Consulteer eveneens uw arts

- bij zwangerschap
- bij ziektes, zoals verlammingen, epilepsie, hoge bloeddruk
- als u drager van een implantaat bent
- bij huidziektes, gevoeligheidsstoringen of na behandelingen van de huid
- bij gebruik van medicijnen

Gebruik de infraroodcabine niet

- bij koorts of acute infecties
- trombozes, ontstekingen of open wonden
- bij verstoorde stofwisseling
- onder invloed van alcohol of drugs

Kinderen, oudere alsook voor hitte gevoelige mensen of gehandicapten mogen zich niet alleen in de infraroodcabine bevinden.

Controleer vóór het opwarmen of zich geen huisdieren in de cabine bevinden.

De infraroodcabine is uitsluitend voor de warmtebehandeling bestemd. Een ondeskundig gebruik (bijv. voor het drogen van de was e.d.) is ten strengste verboden.

Omdat er bij het eerste gebruik geurvorming kan ontstaan, moet de cabine vóór het eerste gebruik minstens 1 uur lang opgewarmd en daarna goed gelucht worden.

Overeenkomstig VDE 0100 (D) mogen installatie en onderhoud aan de warmtecabine met elektronische bediening alleen worden uitgevoerd door een elektrotechnisch vakman!

Bij de omgang met 230 V netspanning bestaat levensgevaar!

ATTENTIE - WAARSCHUWING!

In het vloerelement en in de wandelementen bevinden zich grote verwarmingssystemen met 230 V netspanning.

Is de IR-cabine eenmaal opgebouwd, dan is het ten strengste verboden om schroeven, spijkers, nietjes etc. in de cabine-elementen aan te brengen en de verwarmingspanelen gedeeltelijk of volledig te bedekken (met bijvoorbeeld handdoek, kussen)!

BRANDGEVAAR, LEVENSGEVAAR!

Onderhoudstips

We raden u aan om in de cabine op saunadoeken te zitten zodat het zweet niet op de houten delen loopt. Ventileer de cabine goed na elk gebruik.

Zorg ook voor een goede ventilatie van de ruimte waarin de cabine zich bevindt.

De verwarmingsoppervlakken in het interieur van de cabine zijn onderhoudsvrij. Ze mogen niet worden afgedekt of in contact komen met vocht. Hardnekkig vuil op het hout kan worden verwijderd met schuurpapier.

Enige uitloop van hars aan het houtoppervlak is onvermijdelijk. De droge harsresten kunnen met fijn schuurpapier worden verwijderd.

Gebruik geen chemische lijm in de cabine, maar eventueel houtlijm.

Zitvlakken en vloerrooster moeten minstens een keer om de zes maanden buiten de cabine met een zachte borstel en helder water grondig gereinigd worden. .

Technische tips

Voorwaarden voor het aansluiten van de infraroodcabine: een met 16A afzonderlijk beveiligd stopcontact
Informatie over bediening en aansluiting van de IR-besturing vindt u in de montagehandleiding van de bedieningseenheid en van de IR-besturing FL.

De folievoeler is al door ons gemonteerd en bevindt zich in een achterwandelement.

Het vermogen van de gloeilamp voor de cabineverlichting mag maximaal 40 W bedragen!

Zorg ervoor dat het stopcontact altijd vrij toegankelijk is.

De meegeleverde netaansluitleiding is in het geval van een latere vervanging alleen via de wekklantendienst te verkrijgen.

Om het apparaat helemaal van het net af te sluiten dient u de stekker uit het stopcontact te trekken.

Aan het vermogensdeel bevinden zich onder andere telkens 2 bussen voor de verwarmingscircuits 1-3.

Bij het aansluiten van de kabels voor de stralers is het niet belangrijk welke van de beide bussen gebruikt worden.

Om zakken van de glazen deur te voorkomen, zet u de inbusbouten van het beslag vast.

Deurvleugels

Met de verstelexcenters pos. 42 kunt u de glazen deurbladen ook naderhand altijd gemakkelijk bijstellen. Hiervoor worden de binnendelen van de deurbeslagen gedemonteerd en de excenters in de betreffende richting gedraaid.

Bij het monteren van de deurgrepen dient u erop te letten dat de stalen handgreep zich aan de buitenkant van de deur bevindt.

Instructies voor montage

Alle schroefverbindingen voorbereiden

om beschadiging van de houten delen te voorkomen.
Het volgende symbool maakt u in de handleiding nogmaals hierop opmerkzaam:

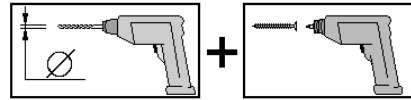

Technische gegevens:

- buitenafmetingen B x D x H : 212 x 121 x 199 cm
- Vermogen bij infraroodfunctie: 3336 W
- Vermogen bij saunafunctie: 3600 W
- Aansluiting: 230 V~16A

- Voorverwarmtijd infraroodfunctie: ca. 45 min. bij 20°C omgevingstemperatuur
- Energieverbruik infraroodmodus ca. 2,7 KWh bij 90 min. toepassingsduur

- Voorverwarmtijd saunafunctie: ca. 30 min. bij 20°C omgevingstemperatuur
- Energieverbruik saunamodus ca. 10,8 KWh bij 4 uur. Gebruiksduur

Gereedschap

Het volgende gereedschap moet u vóór het begin van de montage gereed hebben liggen.

**waterpas
schroevendraaier**

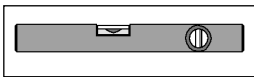

rolmaat

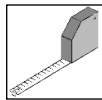

boormachine

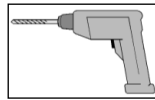

fittingschroevendraaier

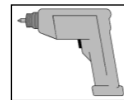

potlood

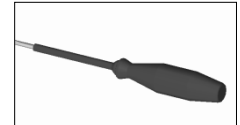
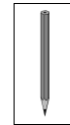

kapzaag / handcirkelzaag

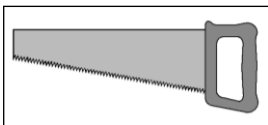

inbussleutel

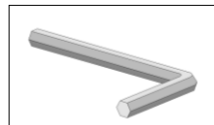

universeel mes

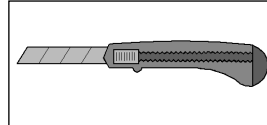

hamer



Afkortingen/Pictogrammen:

cm
mm
ca.

centimeter
millimeter
circa

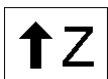

opening toevoerlucht



opening afvoerlucht



Opbouwvarianten

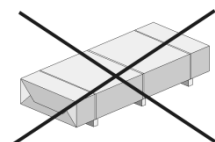

Niet inbegrepen bij de levering!

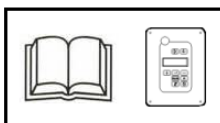

Bedieningshandleiding van de IR-besturing in acht nemen!

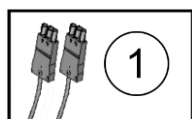

Leidingen van pos. 1 = vloerelement

Garantiebepalingen van weka Holzbau GmbH

Wij geven u vanaf leverdatum 5 jaar garantie op de werking van de houten onderdelen van onze producten (weka-product genoemd). Wij verlenen geen garantie op niet-houten componenten of onderdelen van het weka-product. Garantie wordt op de onderstaande voorwaarden verleend. Binnen de garantieperiode zorgen wij naar onze keuze voor vervanging of aanvulling van foutieve of ontbrekende onderdelen van het product of van het product zelf. Binnen de garantie valt alleen de gratis vervanging van het desbetreffende gebrekkige of defecte houten onderdeel. Niet binnen de garantie vallen gevolgbkosten of bijkomende kosten, in het bijzonder leverings-, montage- of verbouwkosten.

Garantie is uitgesloten als:

- van de bijbehorende montagehandleiding afgeweken werd,
- veranderingen (extra aan- of ombouwwerkzaamheden) aan het product afwijken van de montagehandleiding,
- de vermelde belastingsgrenzen (bijv. sneeuwbelasting etc.) zijn overschreden,
- het weka-product verkeerd gefundeerd (fundering/vloer e.d.) werd, in het bijzonder als dit in strijd is met de regels van de bouwkunst,
- er geen of ontoereikend onderhoud (onderhoud: houtbescherming, verfbehandeling etc.) van het hout uitgevoerd werd.
- Windsnelheden boven sterkte 7, natuurrampen of andere vormen van geweld de schade aan het weka-product veroorzaakt hebben.
- de fout uit voor hout kenmerkende kleurveranderingen, scheurvorming, kromtrekking, krimp, uitzetting of andere veranderingen die natuurlijk zijn voor dit materiaal bestaat.

Garantieclaims kunnen alleen in behandeling worden genomen samen met de originele pakbon en het originele aankoopbewijs en moeten binnen de garantieperiode schriftelijk, per fax of e-mail zijn ingediend. Voorwaarde voor het toekennen van een claim is dat de fout of de schade direct wordt gemeld in de vorm van een duidelijke beschrijving van de schade in woord en beeld.

Garantieclaims moeten worden gestuurd naar:

weka Holzbau GmbH, Johannesstraße 16, 17034 Neubrandenburg
Fax: 0395/42908-83; e-Mail: info@weka-holzbau.com



Voorwaarden voor montage voor weka-montageteam



Wilt u hulp bij het monteren en hebt u hiervoor een montageteam van weka besteld, dan gaat weka Holzbau GmbH voor u als volgt hiervoor te werk:

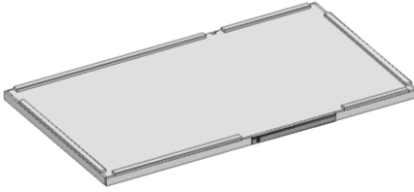
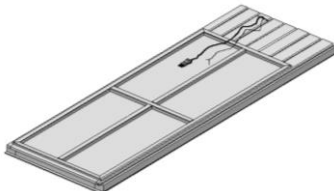
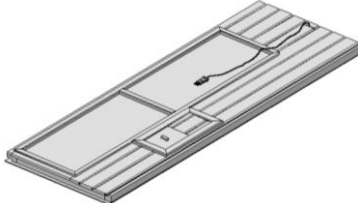
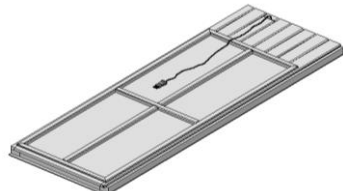
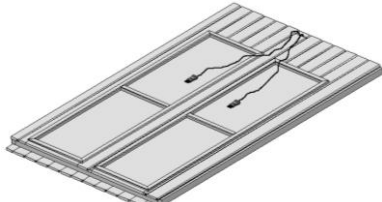
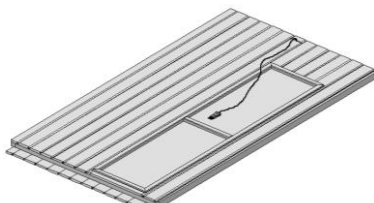
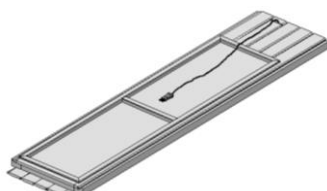

Monteren betekent het volgens de handleiding samenbouwen (opbouwen) van de geleverde productonderdelen zonder lakwerk, levering en montage van accessoires en onderdelen van accessoires. Elektrische aansluitingen vallen niet onder onze montagediensten.

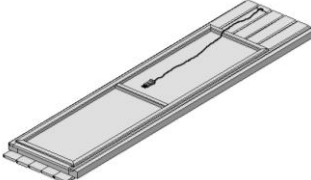
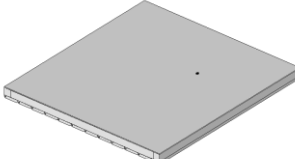
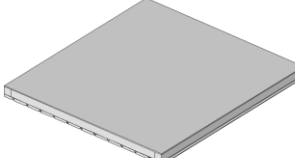
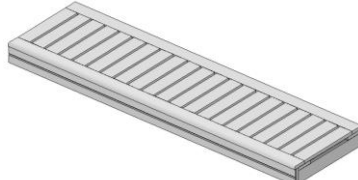
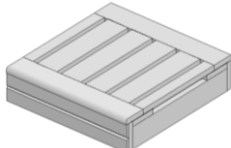
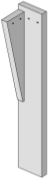

Het op te bouwen product moet zich op de plaats van opstelling bevinden. Vervoer van het product of zijn onderdelen over een afstand van meer dan 10-15m of naar een andere verdieping is niet inbegrepen in de aangeboden montageprijs. De ondergrond moet belastbaar, waterpas en vlak zijn. Voor de vlakheid geldt bij twijfel: DIN 18202 'Ebenheitstoleranzen im Hochbau' (vlakheidtoleranties in de hoogbouw), tab. 3, regel 3, met een maximaal hoogteverschil van ca. 10 tot 11 mm tussen de punten die het verst van elkaar af liggen.



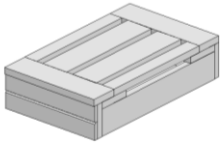
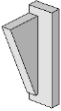

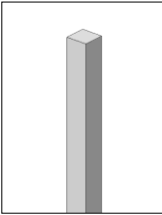
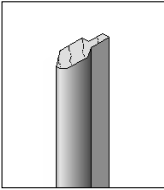
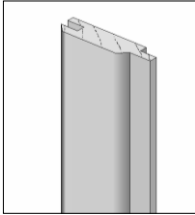
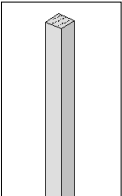
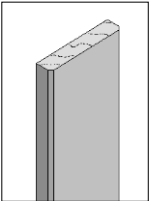
Alle voorbereidende werkzaamheden moeten conform de technische voorschriften voor aanvang van de montage zijn uitgevoerd. De door u gemaakte of gekozen ondergronden/vloeren/funderingen moeten geschikt zijn voor de montage.

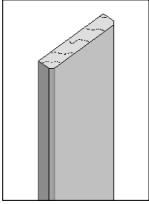
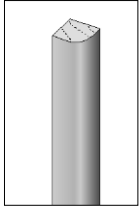
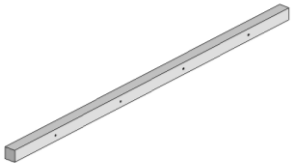

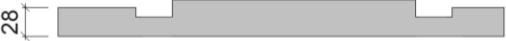
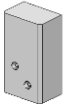
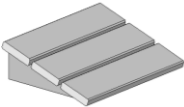

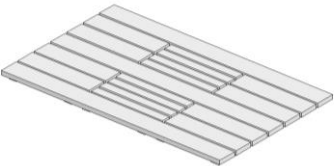
Pos	Bild	Abmessung	Anzahl	
			IR	KOMBI
①	B547.02.0023X 	2090 x 1180	1	1
②	B547.01.0066X RW1 	670 x 1942	1	1
③	B547.01.0067X RW2 	670 x 1942	1	1
④	B547.01.0070X RW3 	670 x 1942	1	1
⑤	B547.01.0068X SW1 	1100 x 1985	1	1
⑥	B547.01.0069X SW2 	1100 x 1985	1	1
⑦	B547.01.0071X FW1 	470 x 1985	1	1
⑧	B547.01.0072 T1 	646 x 1985	1	1

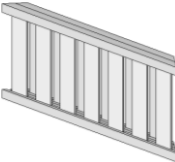



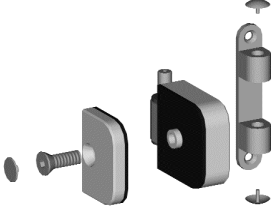

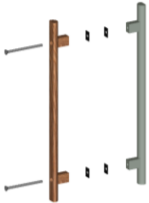
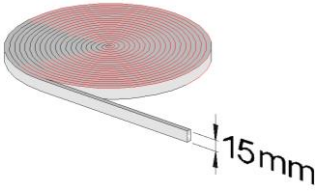
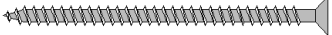
Pos	Bild	Abmessung	Anzahl	
			IR	KOMBI
9	B547.01.0073 FW2 	425 x 1985	1	1
10	B547.01.0074X FW3 	470 x 1985	1	1
11	B547.02.0002 	57/998/1065	1	1
12	B547.02.0003 	57/988/1065	1	1
13	B500.03.0084 	114/550/1960	1	1
14	C547.03.0001 	114/480/500	1	1
15	C547.03.0002 	88/80/483	2	2
16	C547.03.0003 	88/80/483	2	2





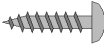

Pos	Bild	Abmessung	Anzahl	
			IR	KOMBI
17	C547.03.0007 	114/300/500	1	1
18	C547.03.0008 	88/80/170	2	2
19	C547.03.0009 	88/80/170	2	2
20	G547.01.0064 	40/40/1942	4	4
21	G547.01.0065 	14/35/1985	4	4
22	G547.01.0066 	14/57/1985	4	4
23	G547.01.0067 	10/10/970	2	2
24	G547.01.0068 	14/70/1985	4	4



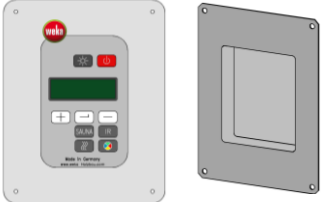

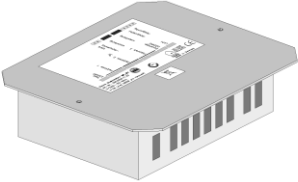

Pos	Bild	Abmessung	Anzahl	
			IR	KOMBI
25	G547.01.0069 	14/54/1985	2	2
26	G547.01.0070 	14/14/1942	4	4
27	G547.01.0012 	30/30/1012	2	2
28	G547.01.0013 	30/30/1985	2	2
29	G547.01.0062 	35/45/530	3	3
30	G547.01.0061 	35/45/530	1	1
31	G500.03.0071 	25/40/80	2	2
32	B500.03.0018 	100/240/325	1	1

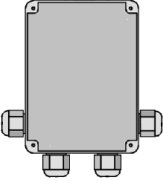
Pos	Bild	Abmessung	Anzahl	
			IR	KOMBI
33				
34				
35				
36	B500.03.0080 	33/614/1000	1	1
37	G547.01.0014 	19/24/395	30	30
38	G547.01.0015 	19/24/605	10	10
39	B500.03.0059 	30/230/410	1	1
40	K107.5520.0000 	8/550/1985	1	1

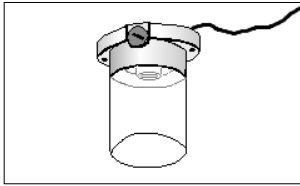
Pos	Bild	Abmessung	Anzahl	
			IR	KOMBI
40-1		10/27/35	2	2
41			2	2
42			2	2
43			1	1
44		10m	2	2
45		5,0 x 80	6	6
46		4,5 x 70	27	27
47		6,0 x 60	8	8

Pos	Bild	Abmessung	Anzahl	
			IR	KOMBI
48		4,0 x 60	6	6
49		4,0 x 50	18	18
50		3,5 x 35	64	64
51		3,0 x 30	80	80
52		3,5 x 15	20	20
53		1,6 x 30	70	70
54	<div style="border: 1px solid black; padding: 5px;"> <p style="text-align: center;">WARNUNG!</p> <p>Im Bodenelement und in den Wandelementen befinden sich großflächige Heizsysteme mit 230V Netzspannung. Nach erfolgtem Aufbau der IR-Kabine gemäß Montageanleitung ist das Einbringen von Schrauben, Nägeln, Heftklammer etc. in die Kabinenelemente, sowie das teilweise oder ganzflächige Bedecken der Heizflächen (zum Beispiel mit Handtuch, Kissen) strengstens verboten!</p> <p style="text-align: center;">BRANDGEFAHR, LEBENSGEFAHR !</p> </div>	120 x 40	2	2
55	<div style="border: 1px solid black; padding: 5px;"> <p style="text-align: center;">SAUNAWELT</p> <p style="text-align: center;">Keinen Schweiß auf's Holz Bitte Handtuch unterlegen.</p> <p style="text-align: center;">WARNUNG Bedeckung des Heizgerätes verursacht Brandgefahr !</p> </div>	4/90/130	-	1

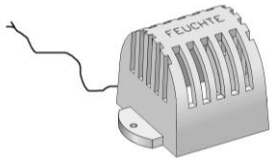
Pos	Bild	Abmessung	Anzahl	
			IR	KOMBI
56	500.0153.00.00 	45/260/330	-	1
57	500.0630.10.00 	130 x 170	1	1
57M1			1	1
57M2		3,9 x 25	4	4
57M3		Ø 12mm	4	4
58	500.0630.17.00 	200 x 240	1	1
58M		4,5 x 70	2	2
59	500.0630.12.00 		-	1

Pos	Bild	Abmessung	Anzahl	
			IR	KOMBI
60	K124.1000.0000 		1	1
60M		4,0 x 40	2	2
61	K047.6000.0001 		3	3
62	K048.1000.3005 		3	3
63			1	2
63M		2,5 x 12	2	2
64			1	1

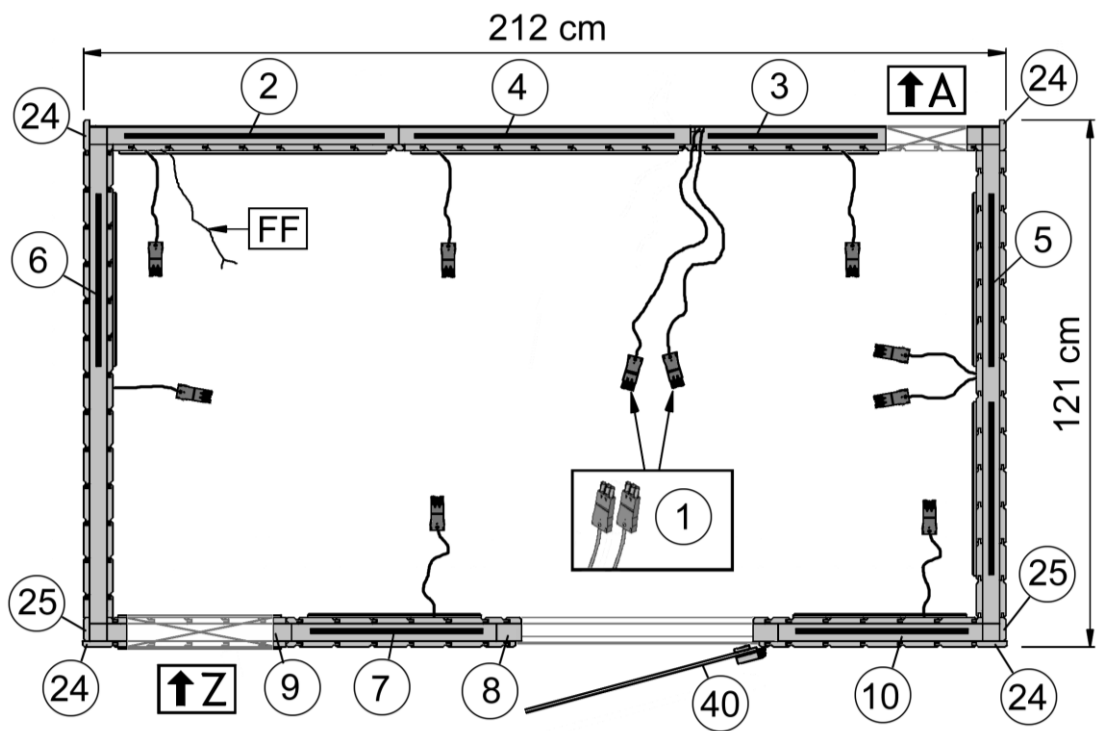
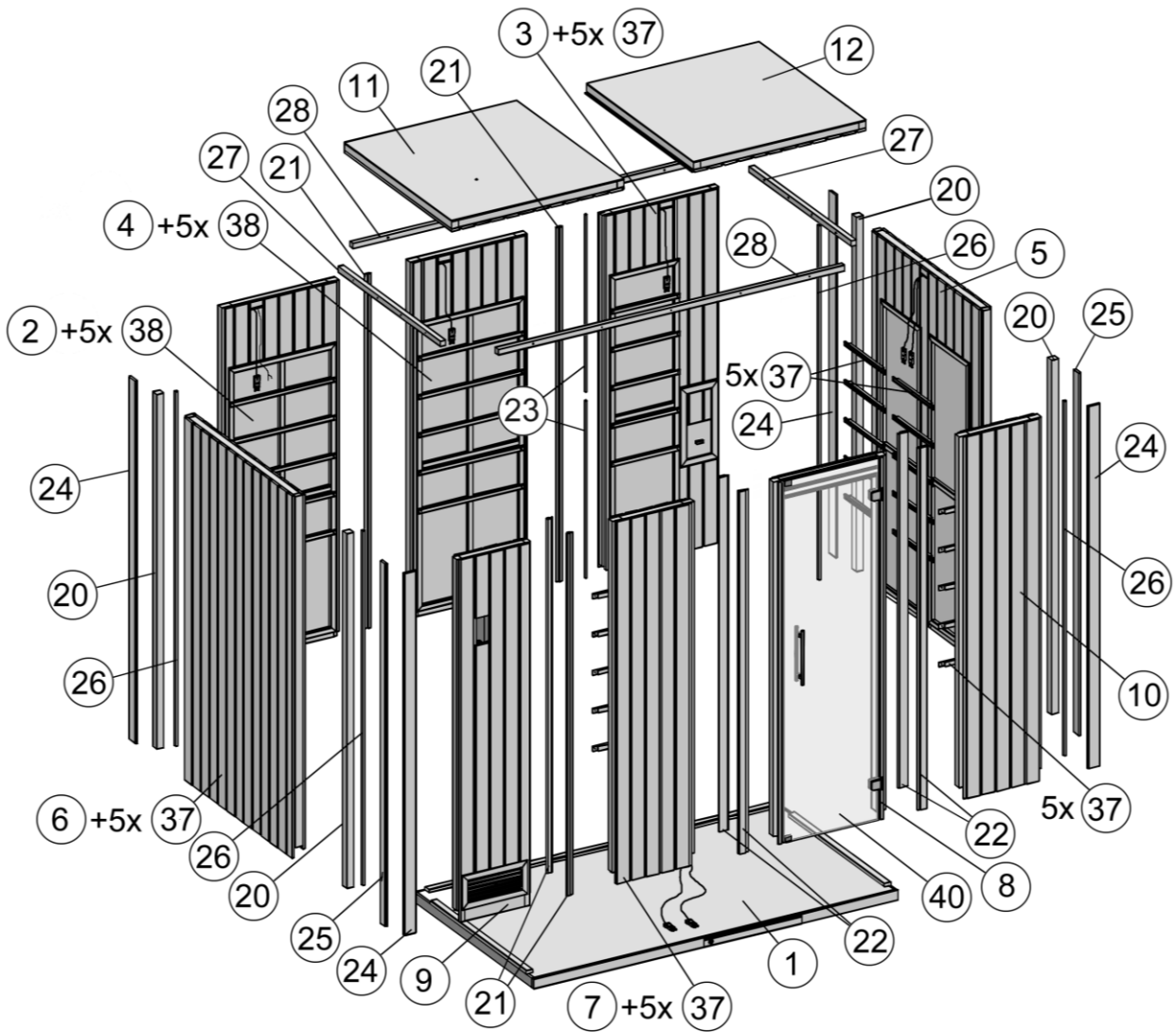

1

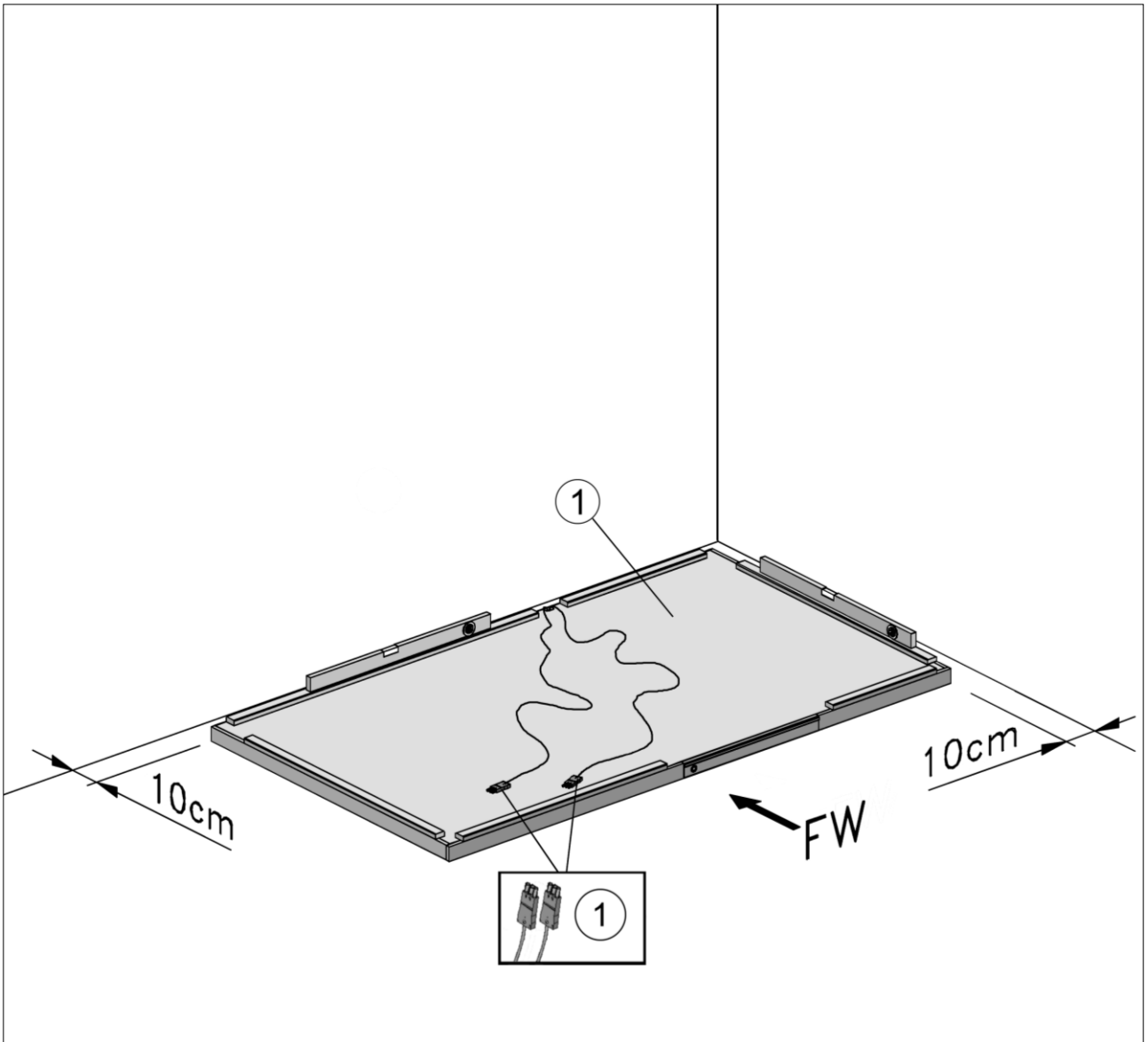
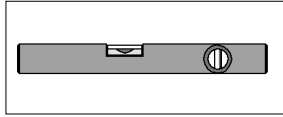
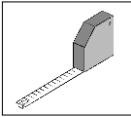

2

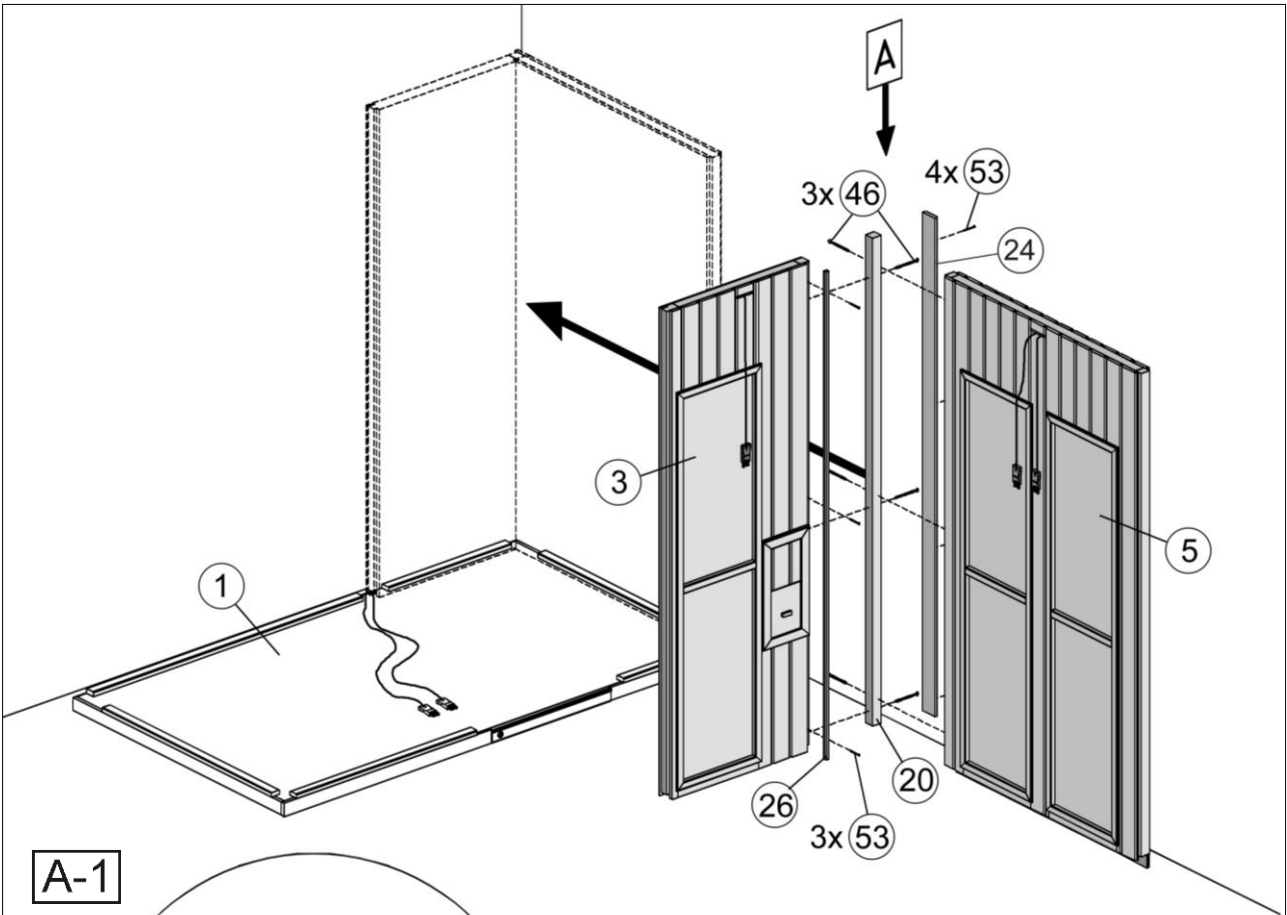
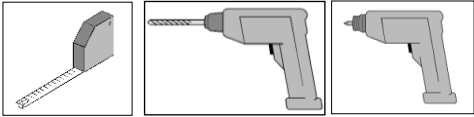

A-1

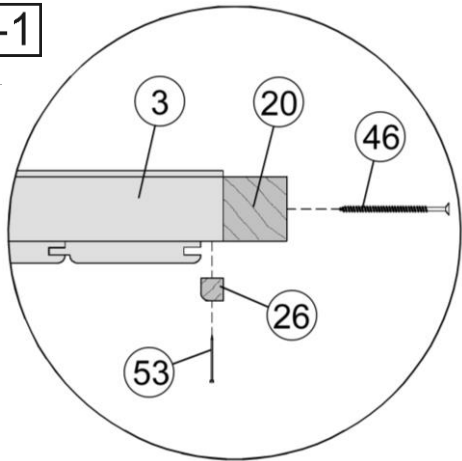

A-2

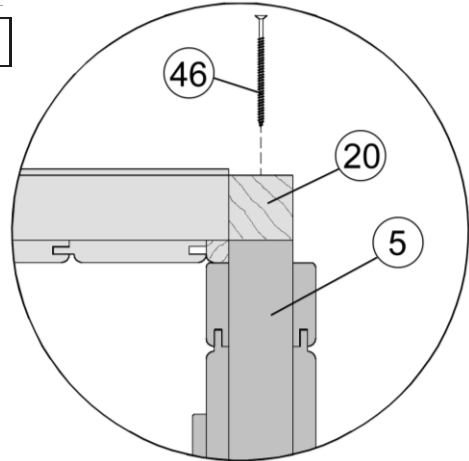

A-3

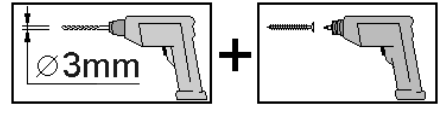
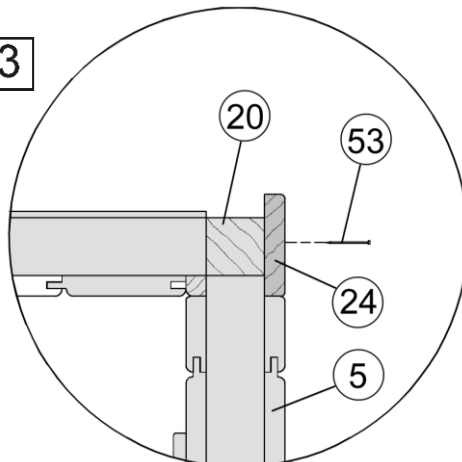

3

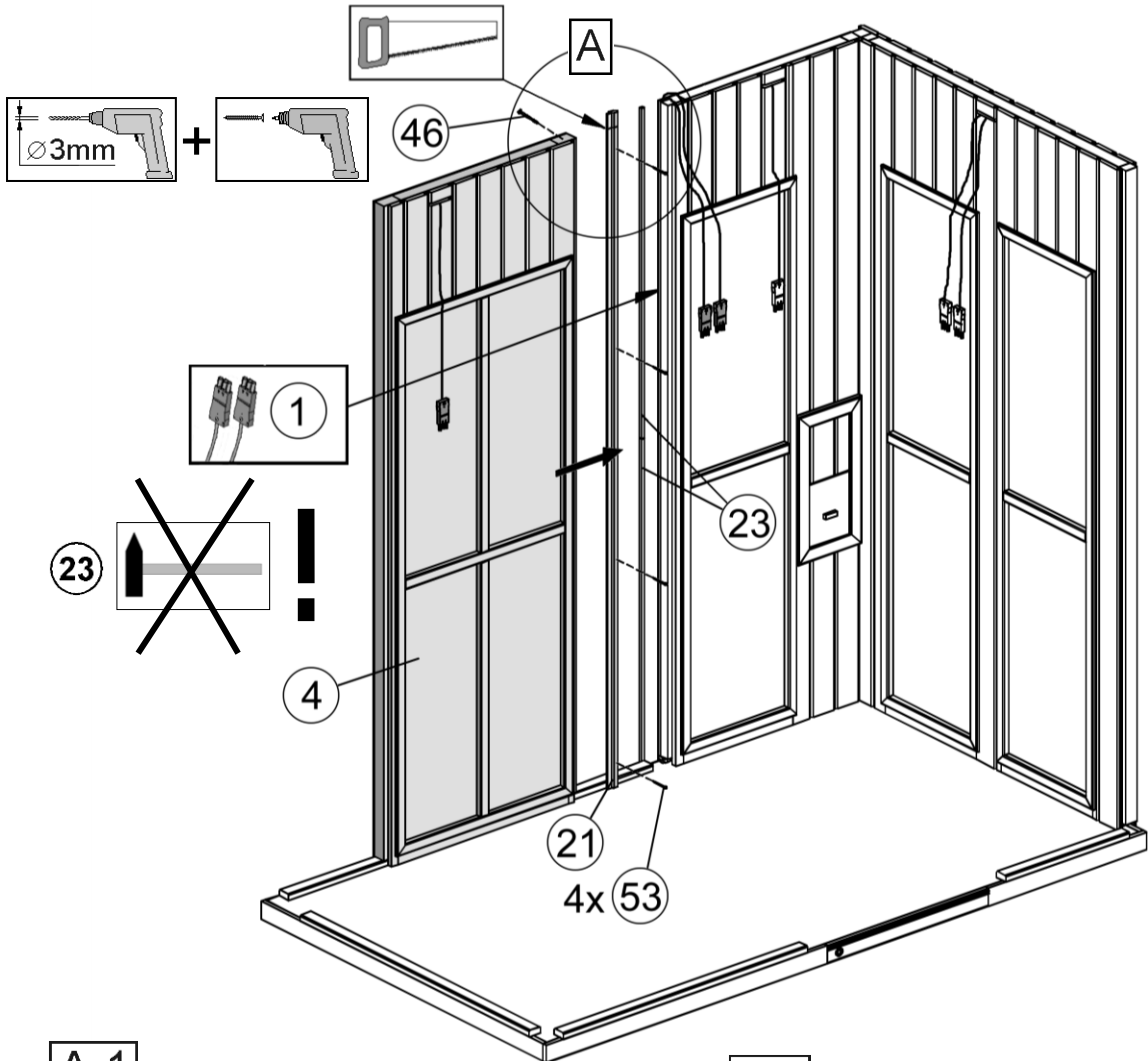
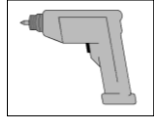
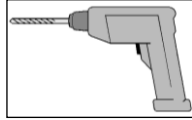
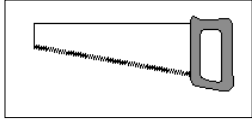
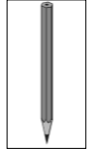
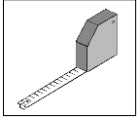

A-1

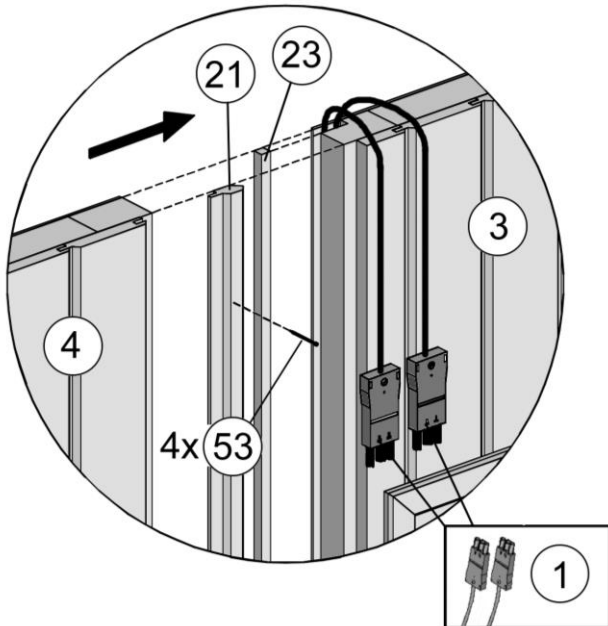

A-2

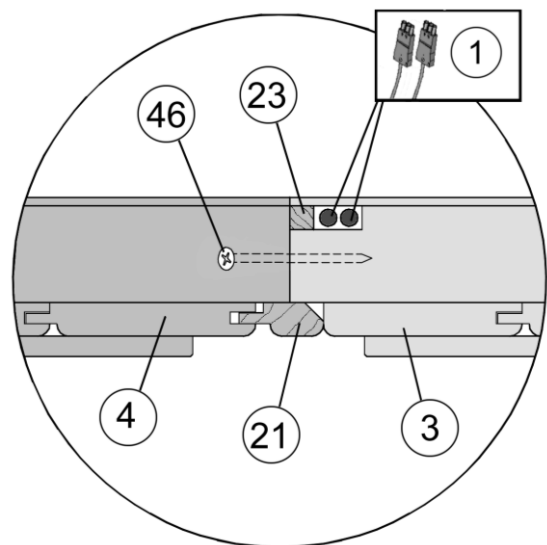

4

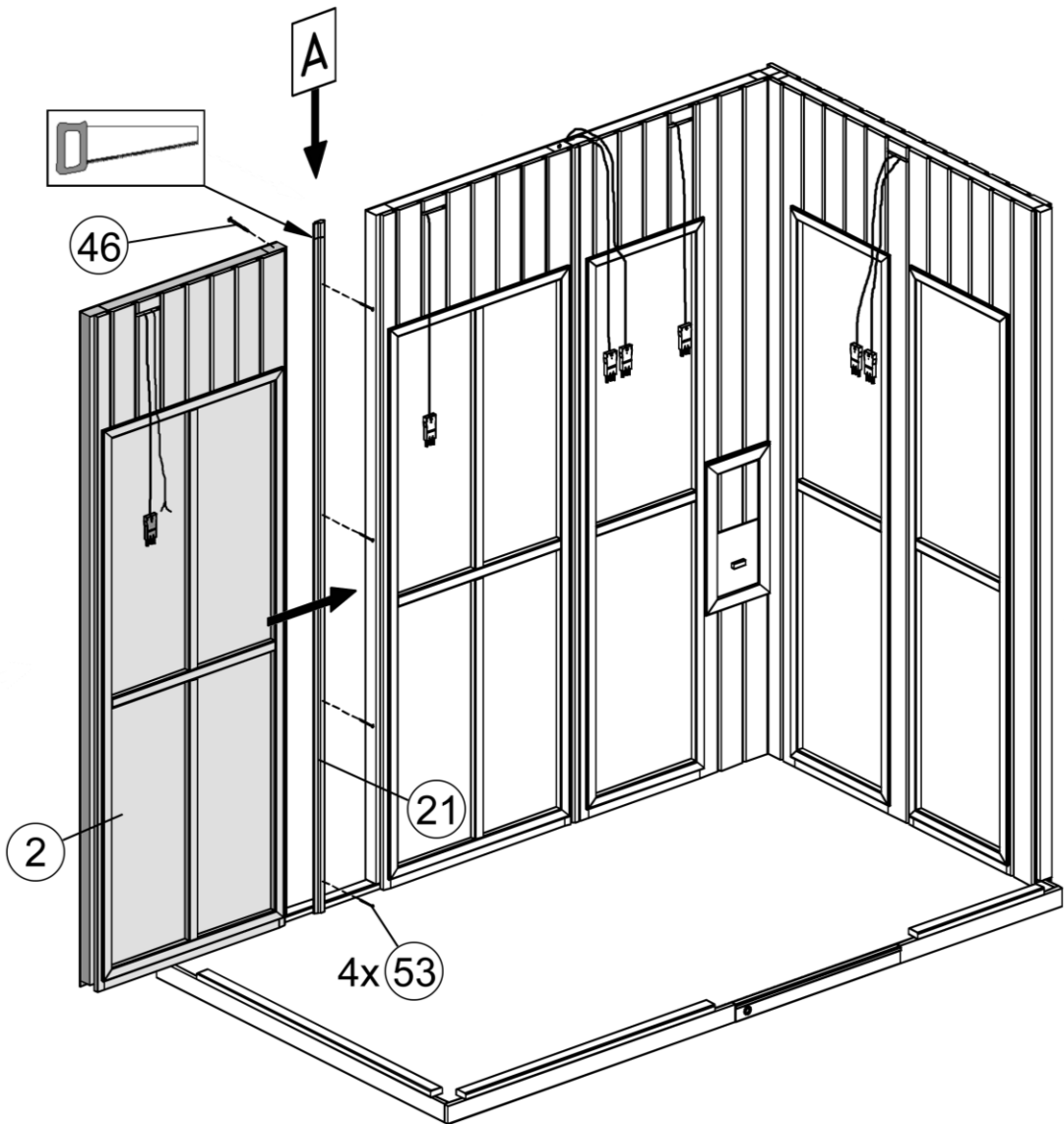
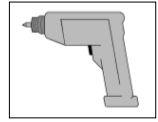
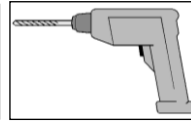
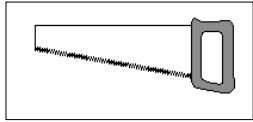
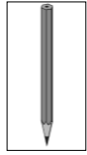
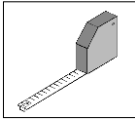

A

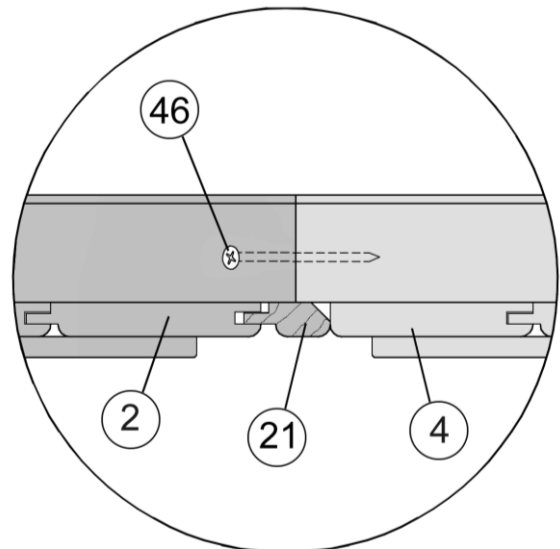
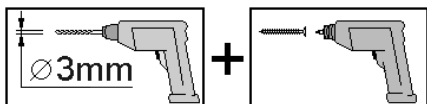

5

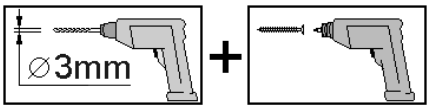
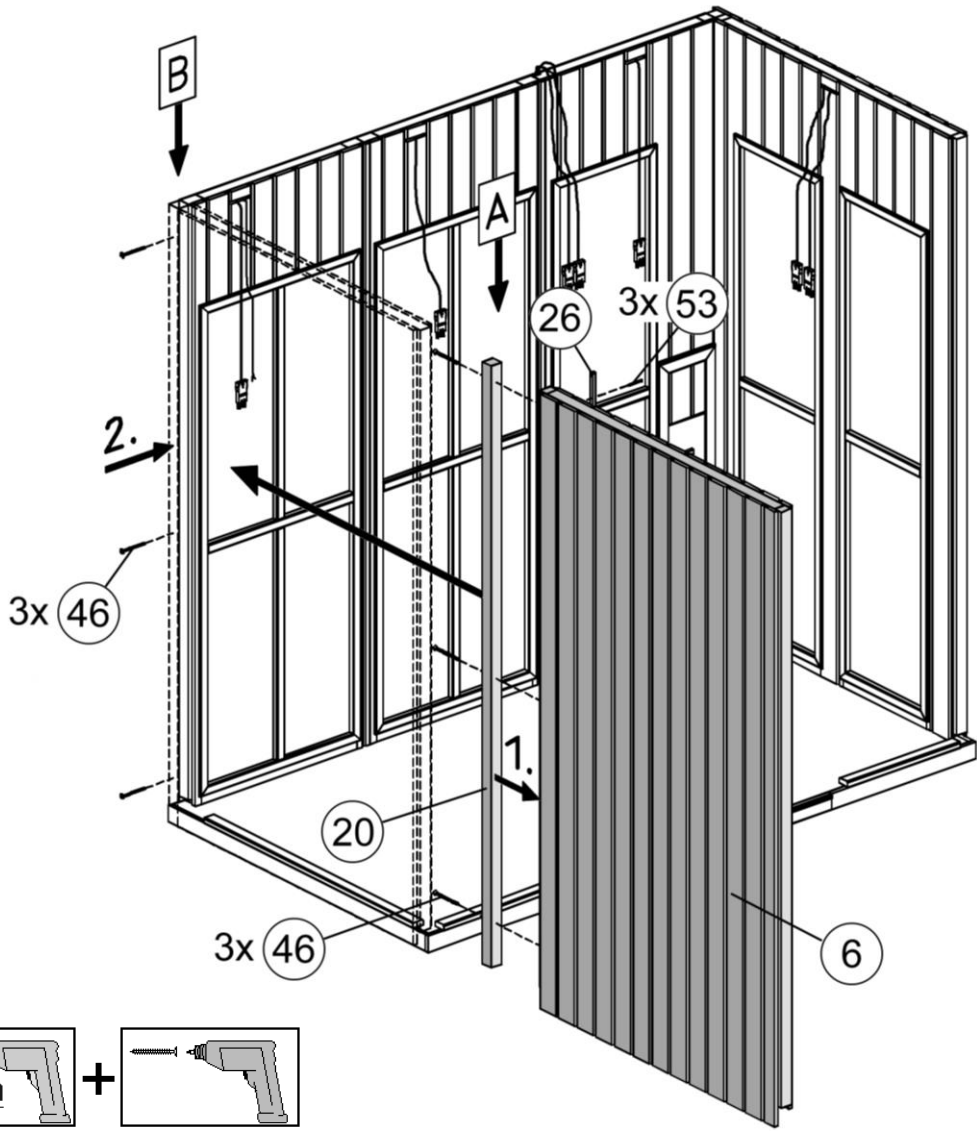
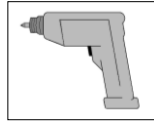
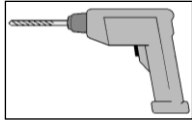
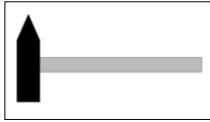

A

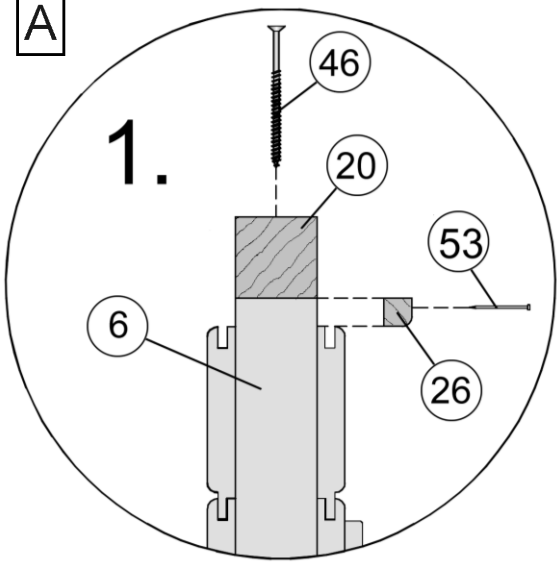

B

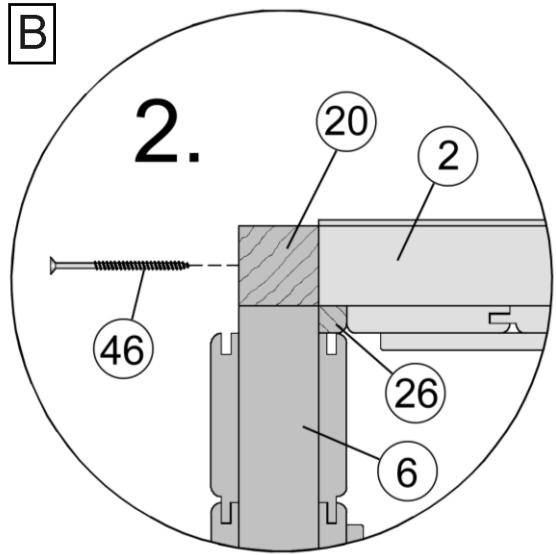

6

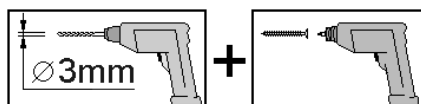
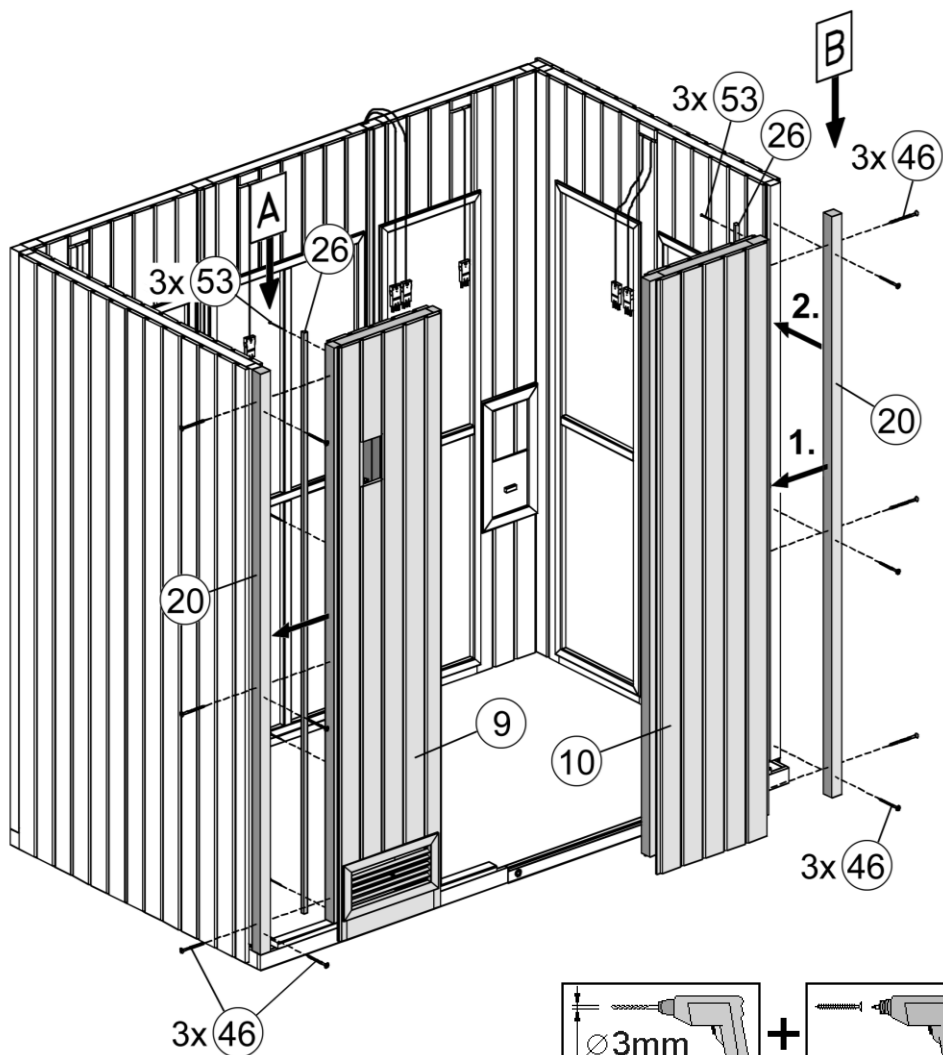
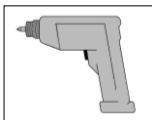
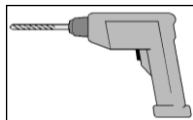
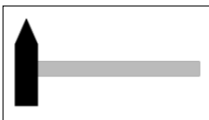

A

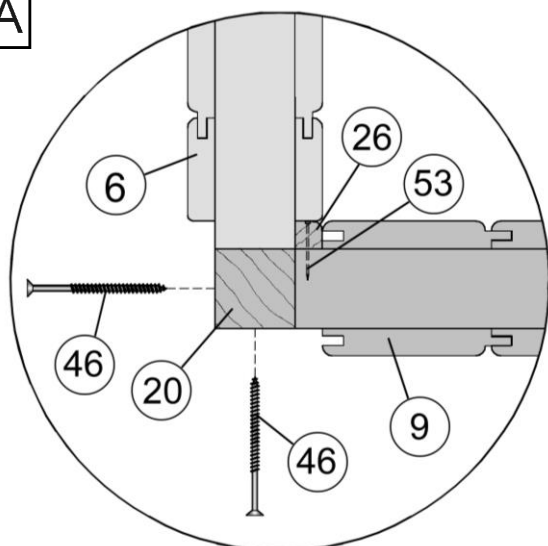

B

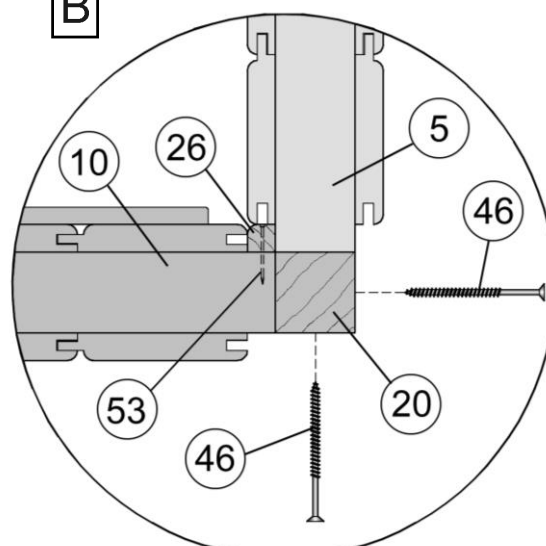

7

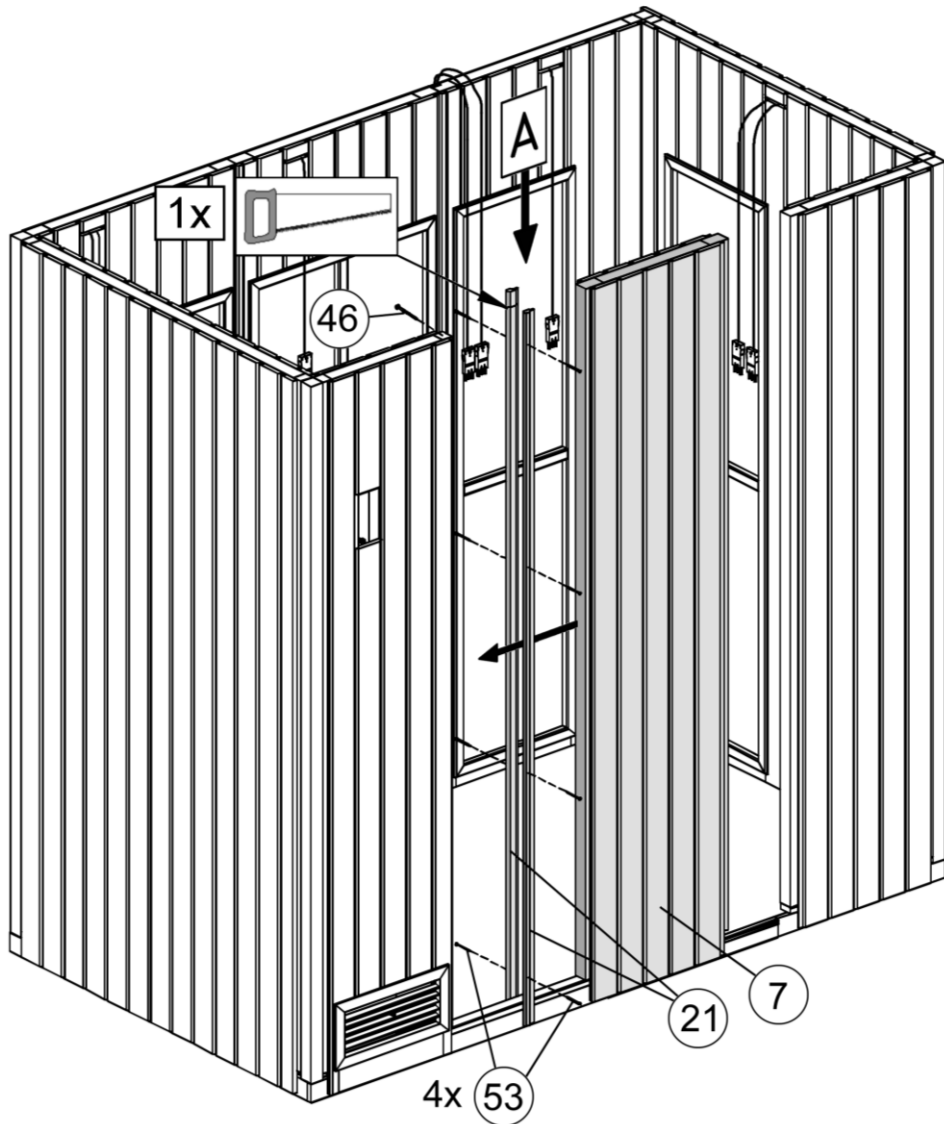
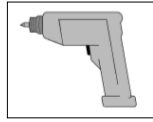
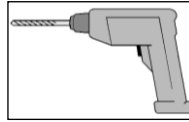
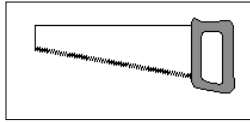
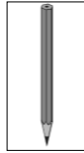
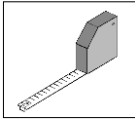

A

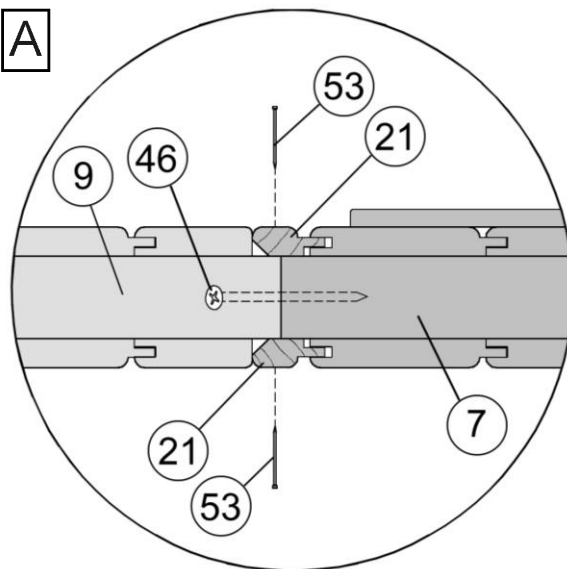
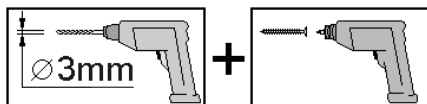

8

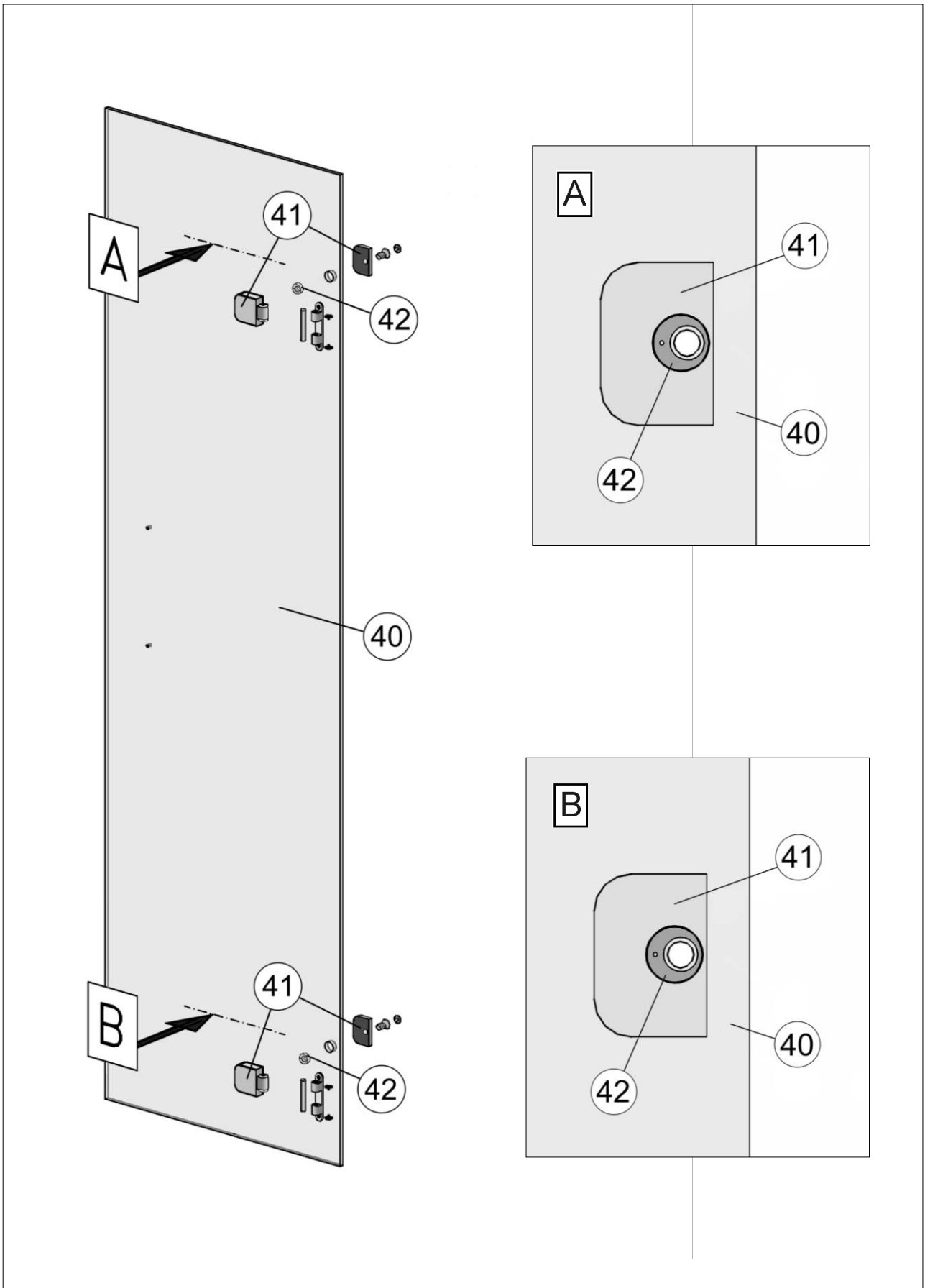
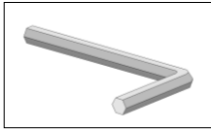

9

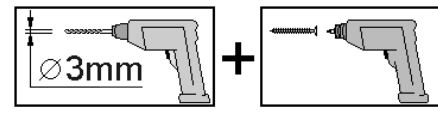
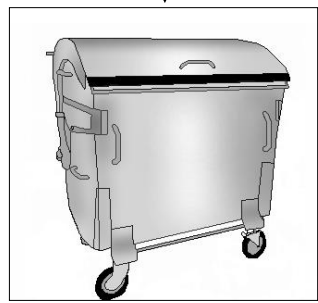
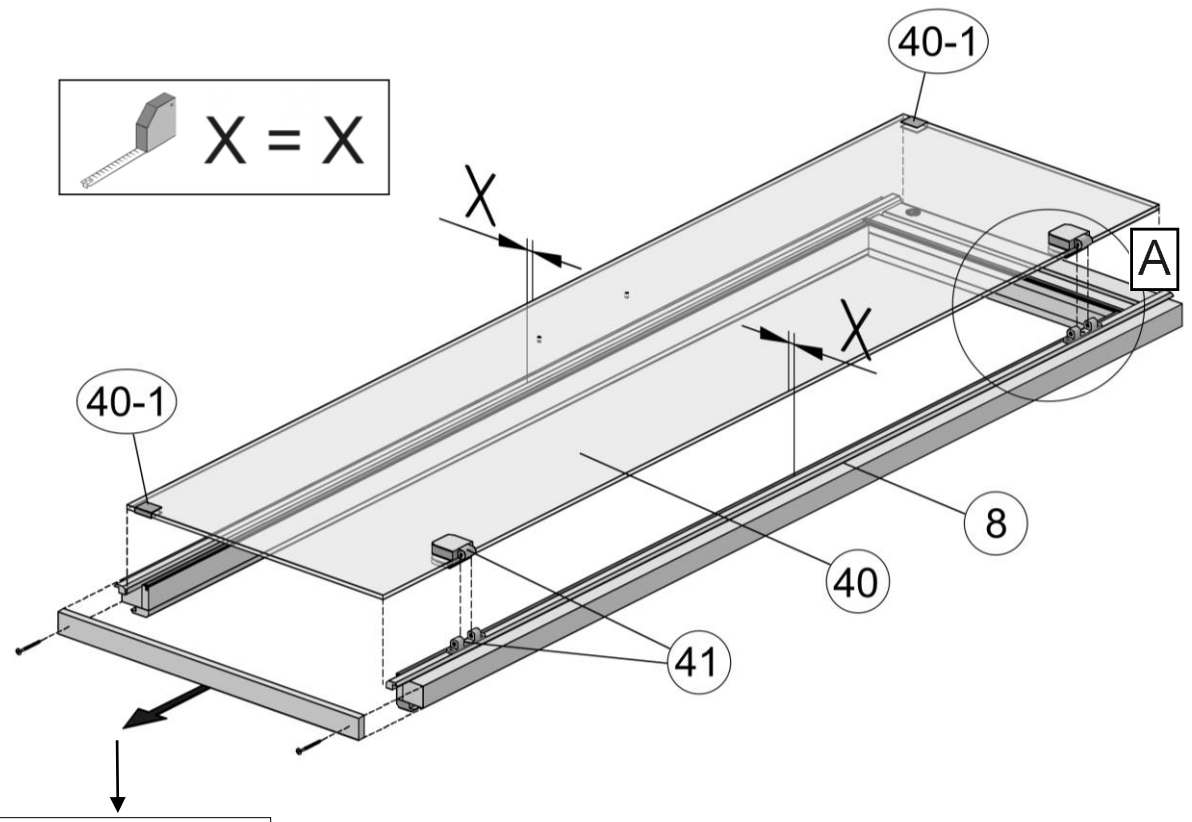
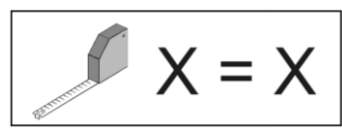
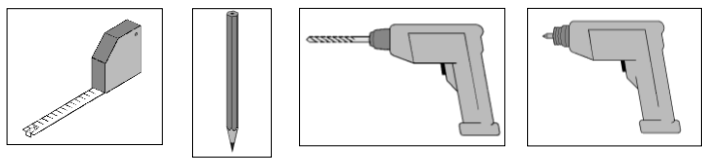

A-1

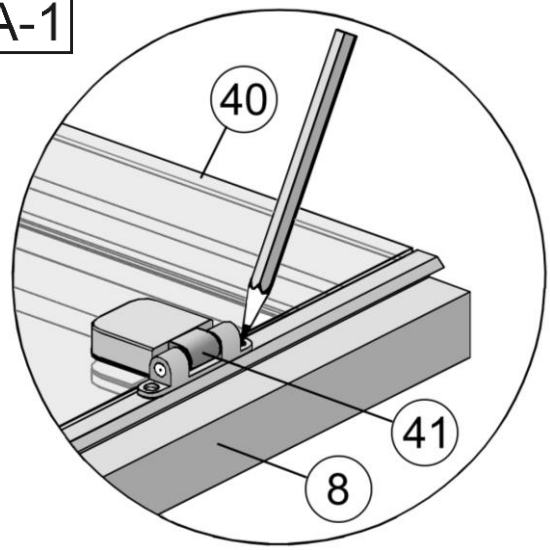

A-2

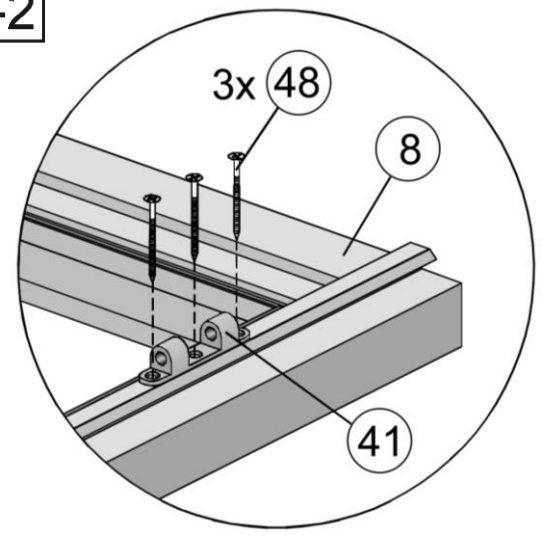

10

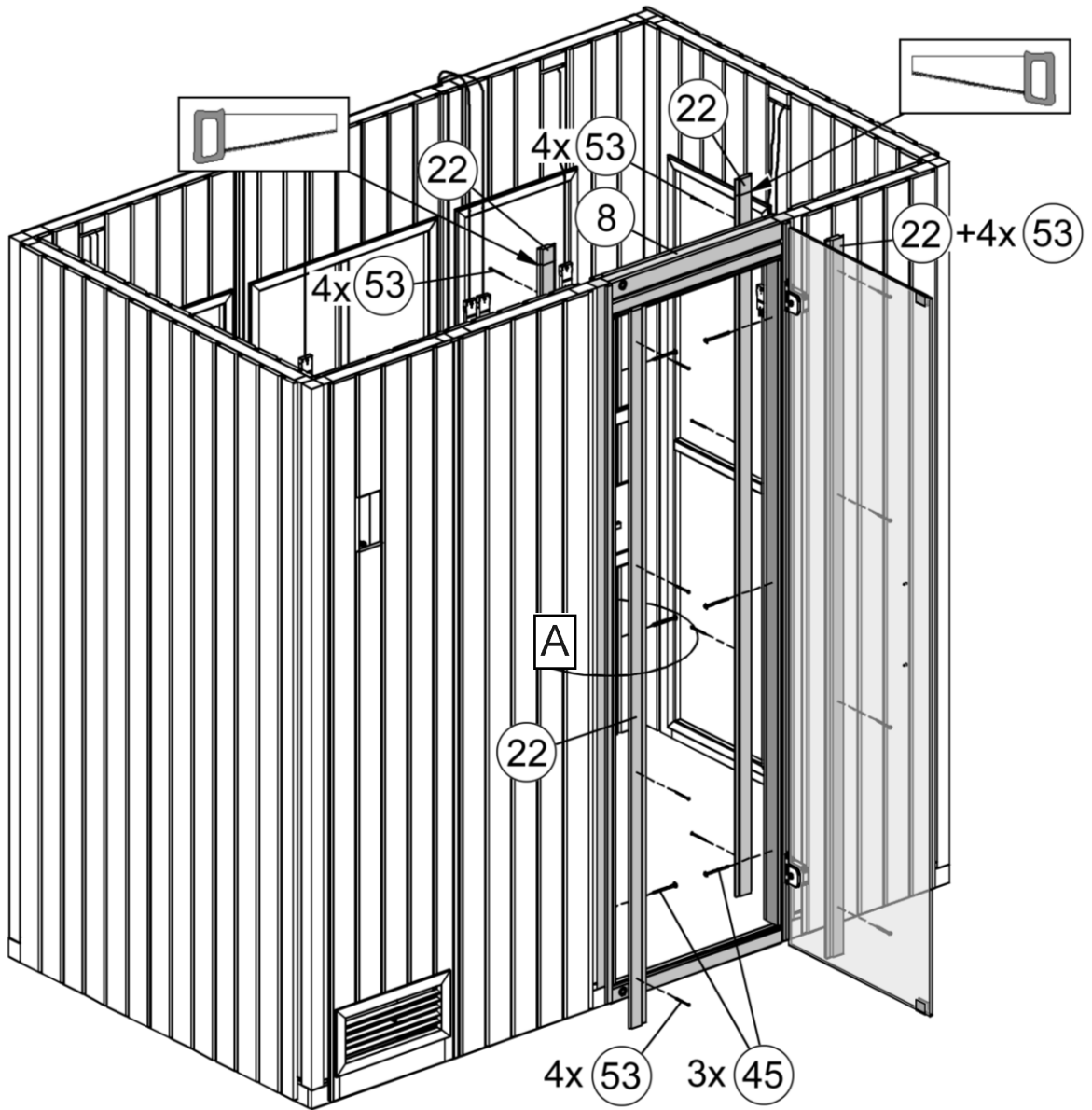
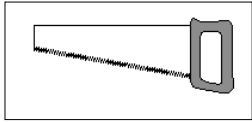
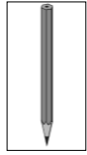
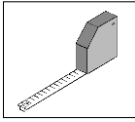

A

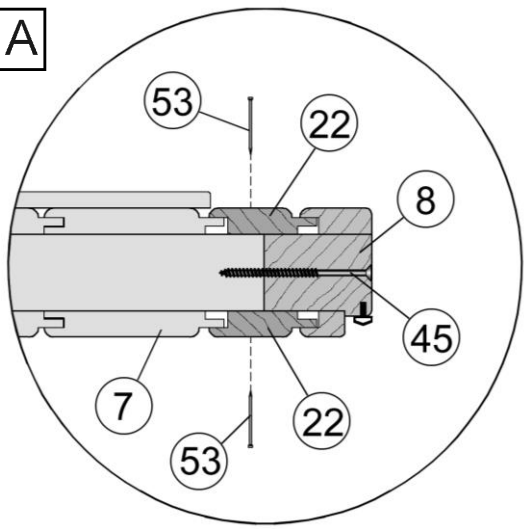

11

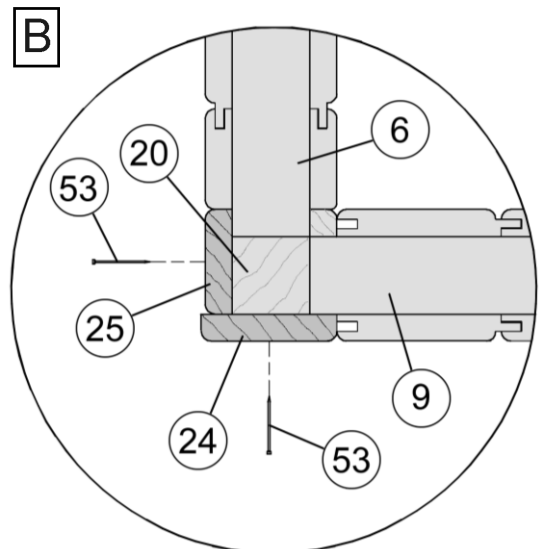
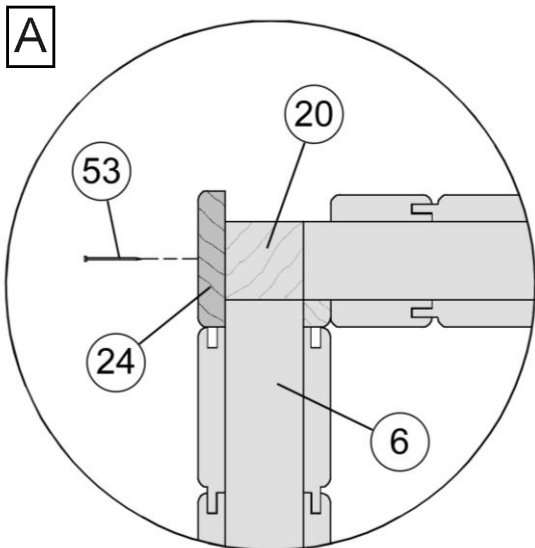
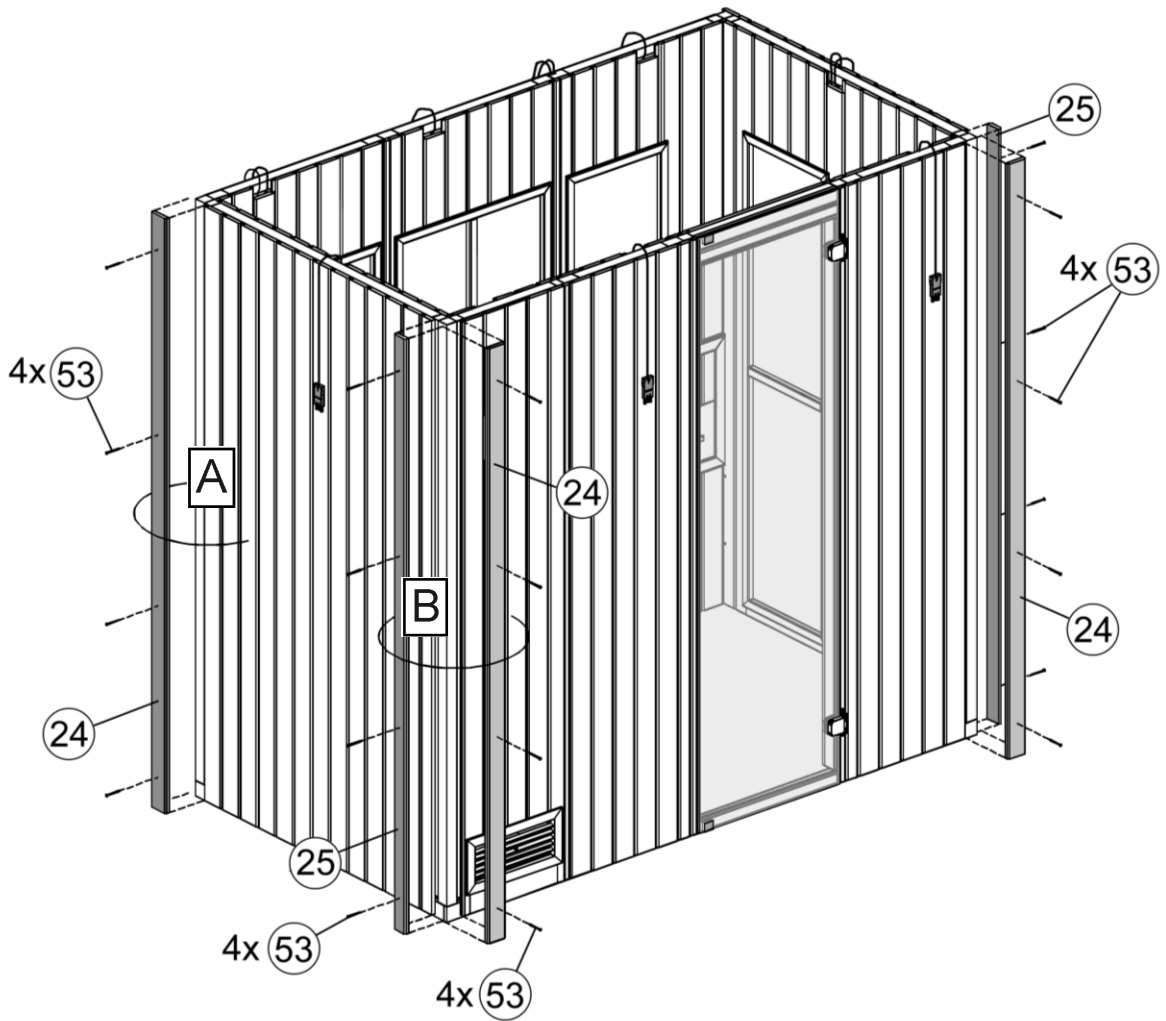

12

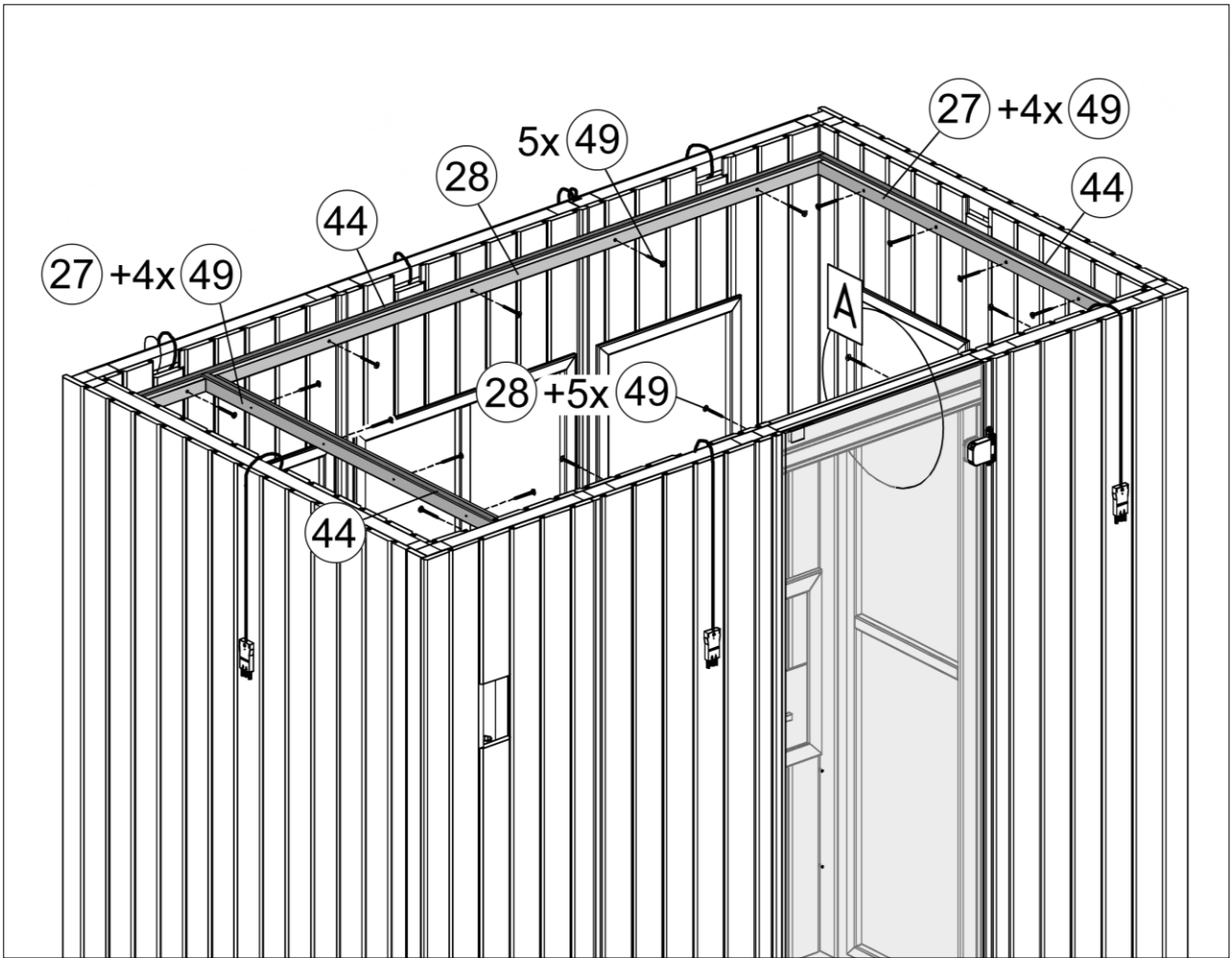
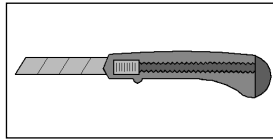
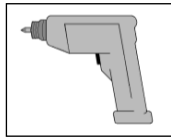
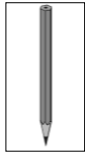
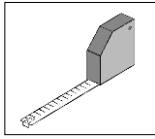

A

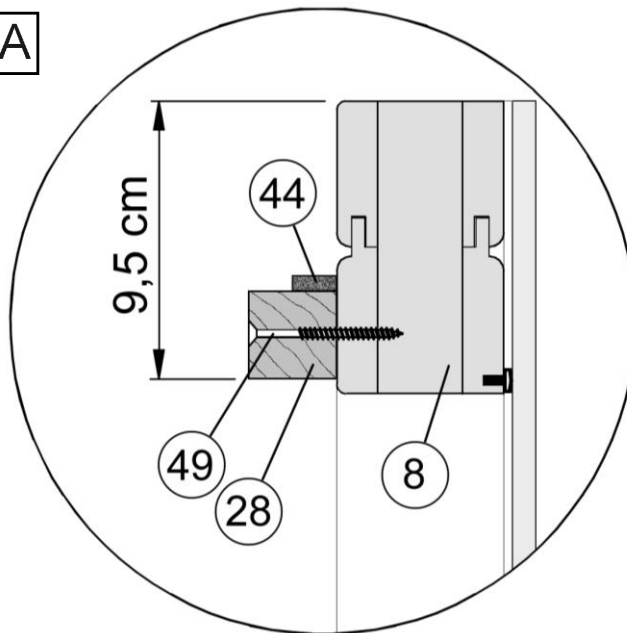

13

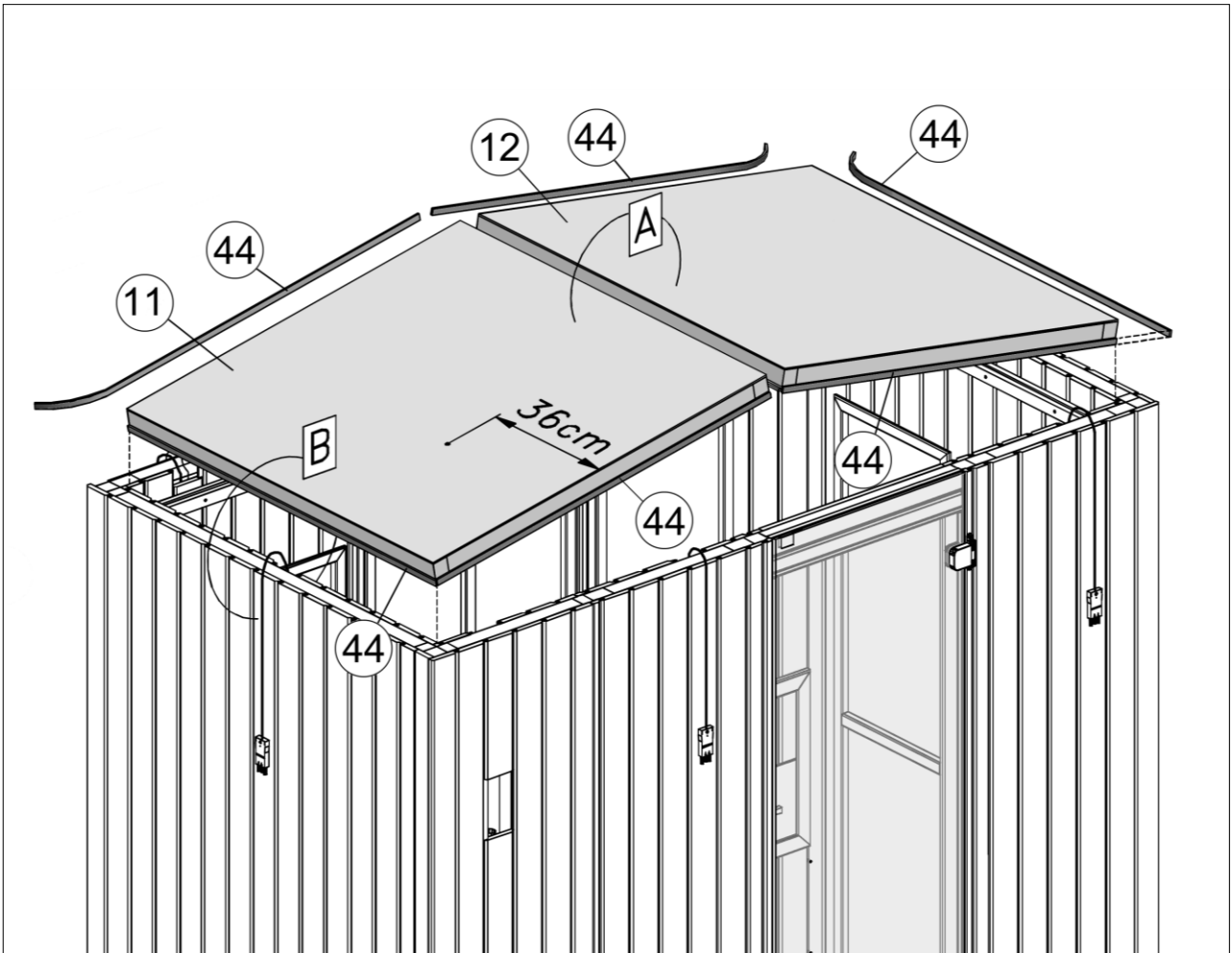
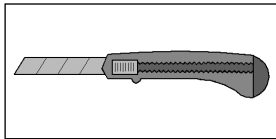

A

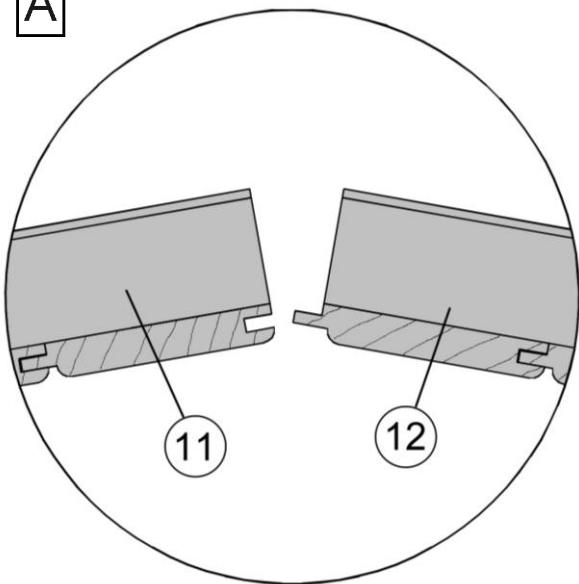

B

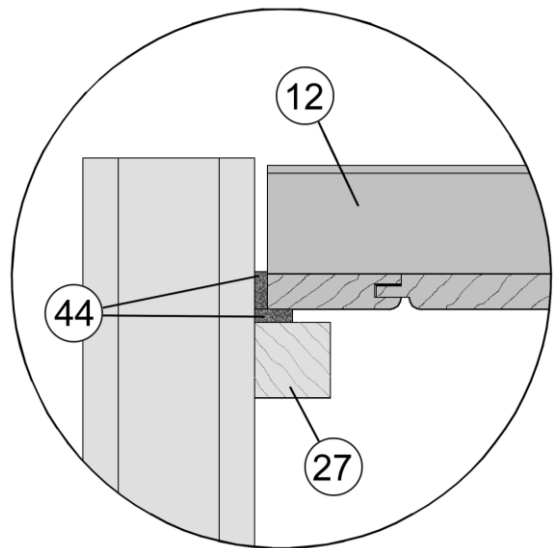

14

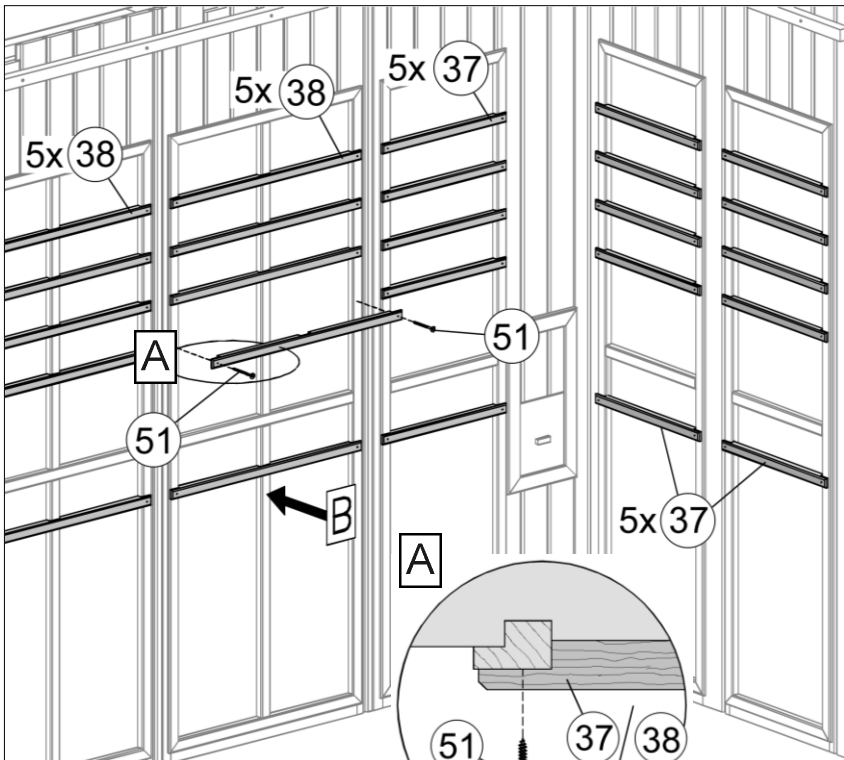
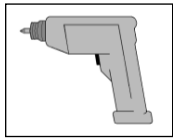
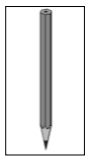
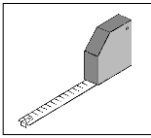

B

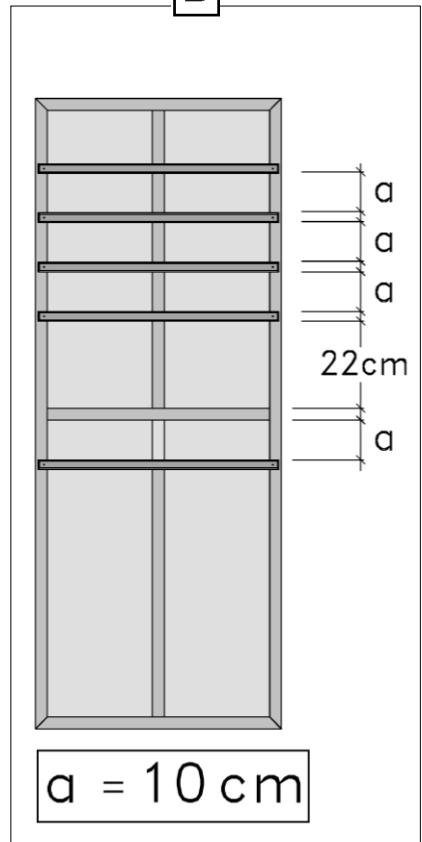

15

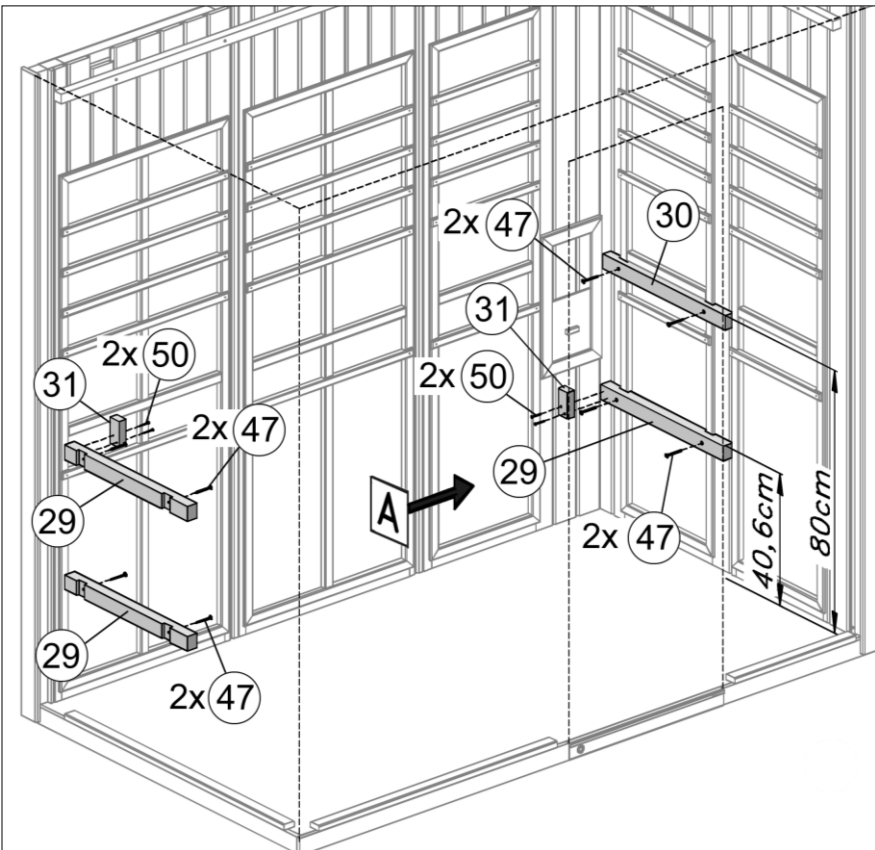
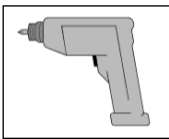

A

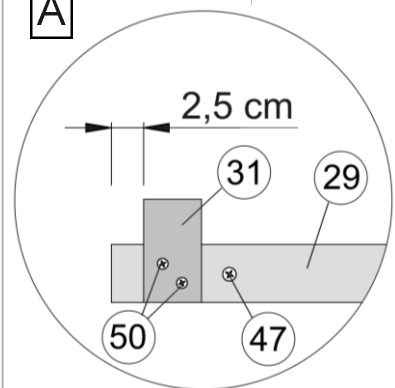

16

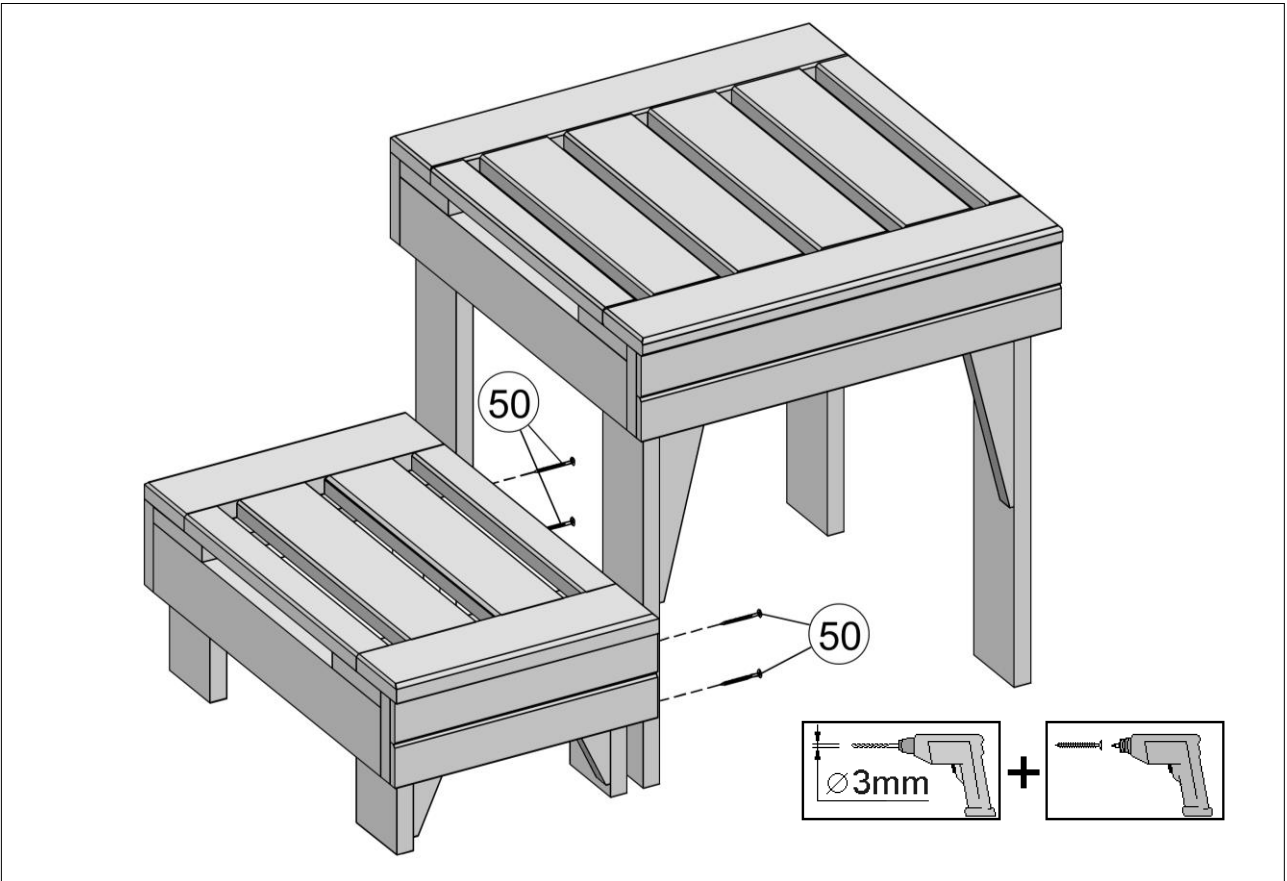
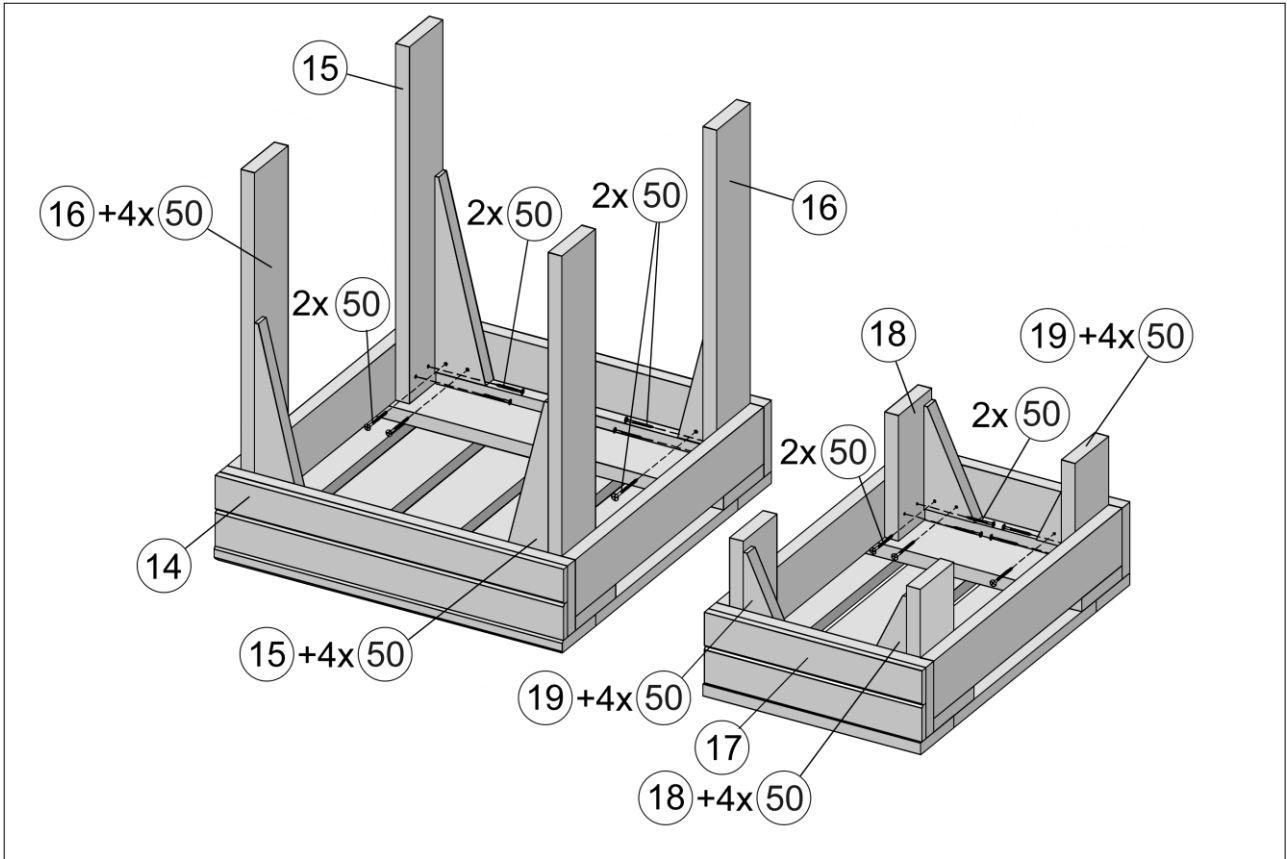
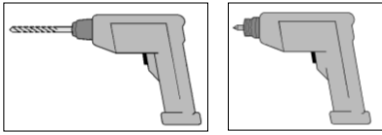

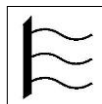
17**IR**

de	Gestaltungsvarianten
en	Design variants
fr	Variantes d'agencement
it	Versioni di allestimento
nl	Designvarianten

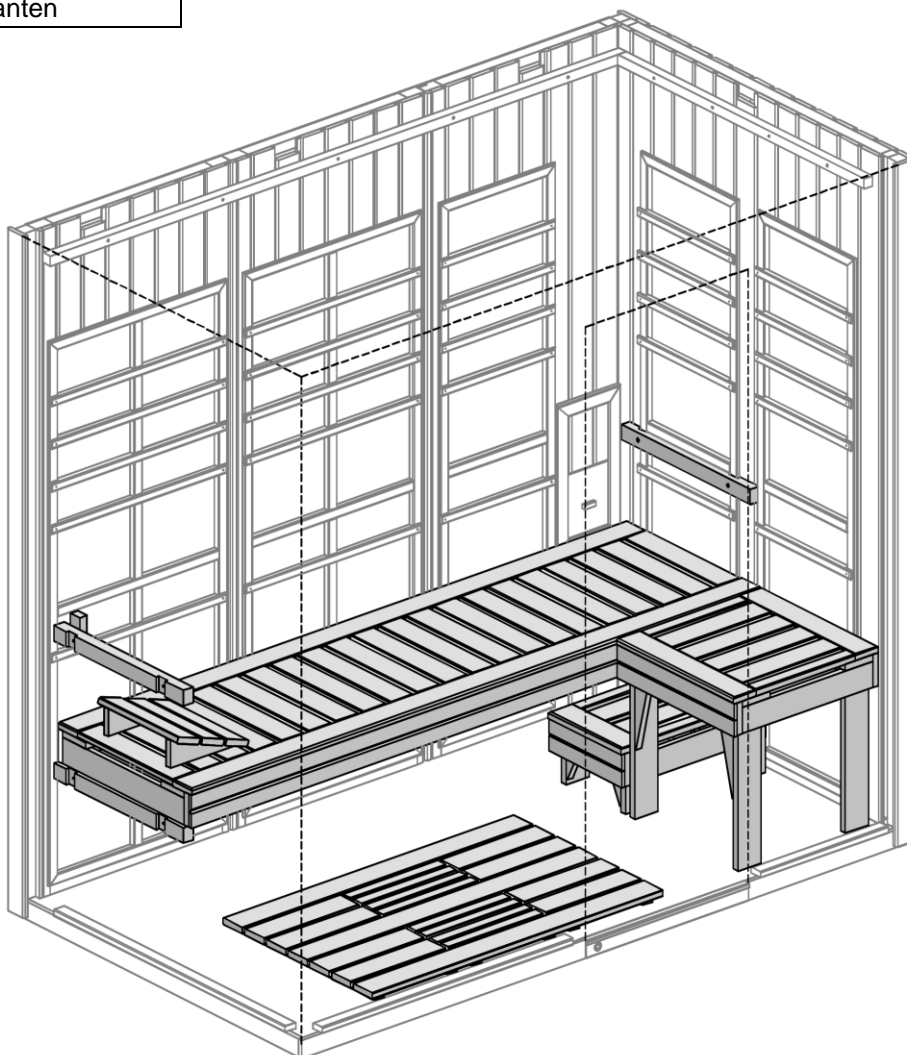
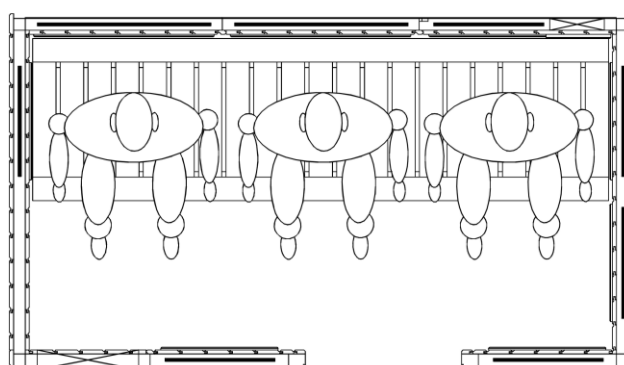
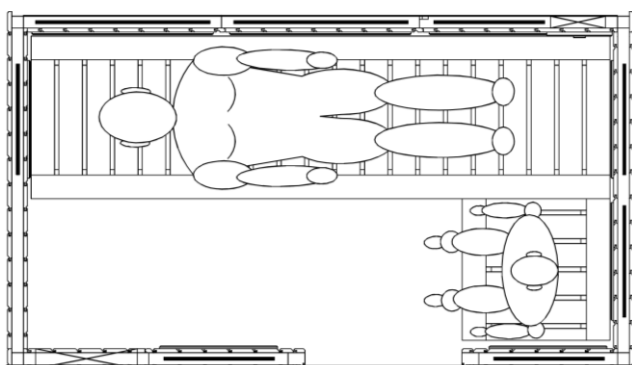
**VARIA 1****VARIA 2**

17

KOMBI

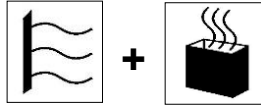

de	Gestaltungsvarianten
en	Design variants
fr	Variantes d'agencement
it	Versioni di allestimento
nl	Designvarianten

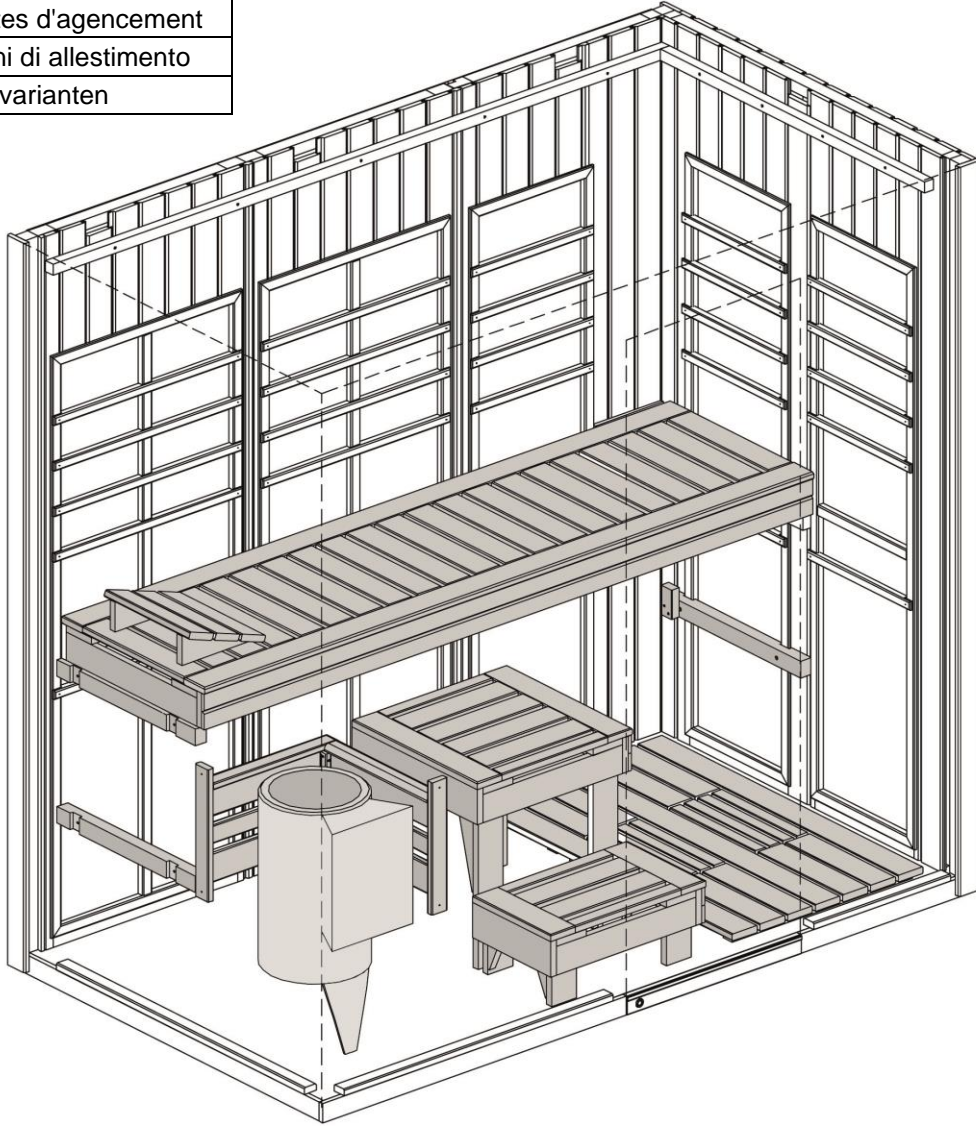

VARIA 1

VARIA 2

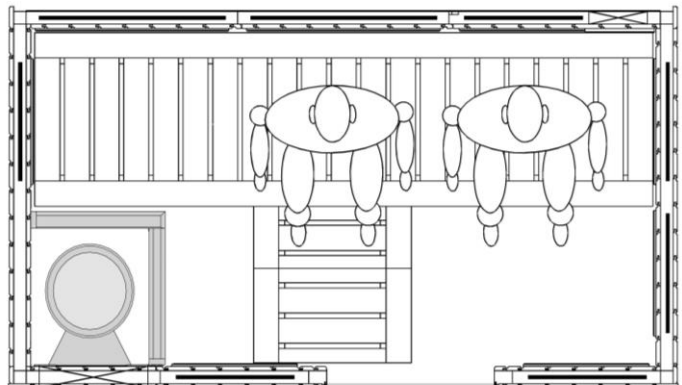
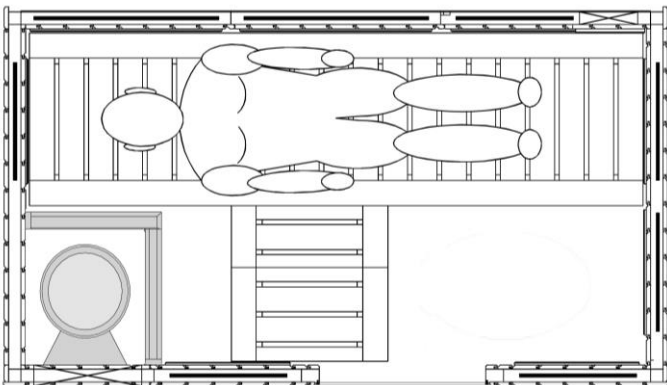

18

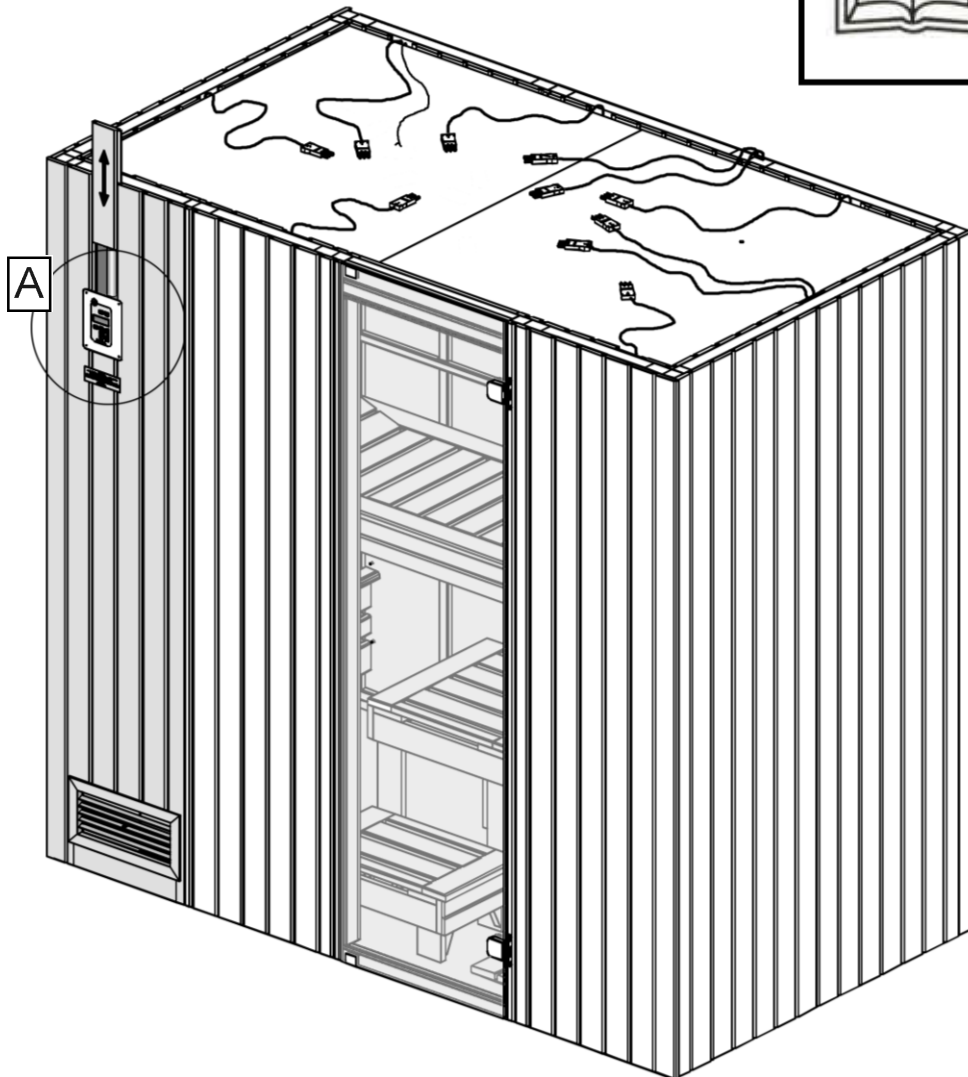
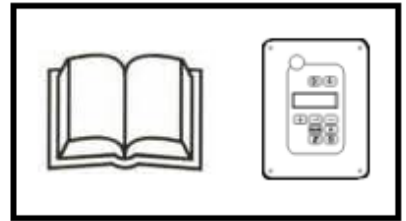
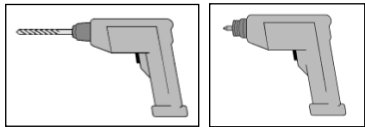

A-1

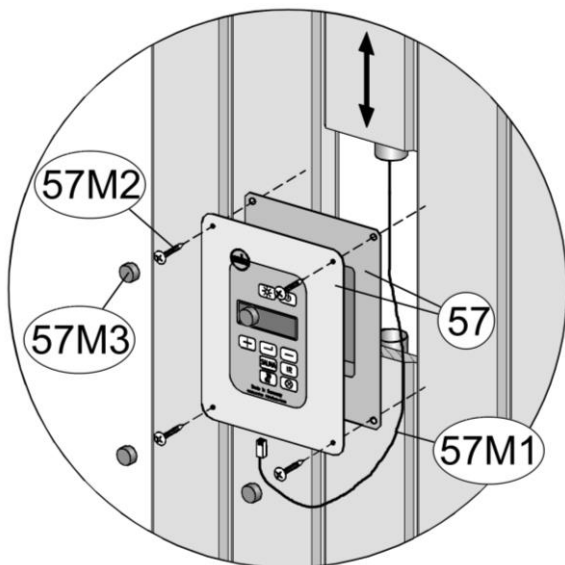

A-2

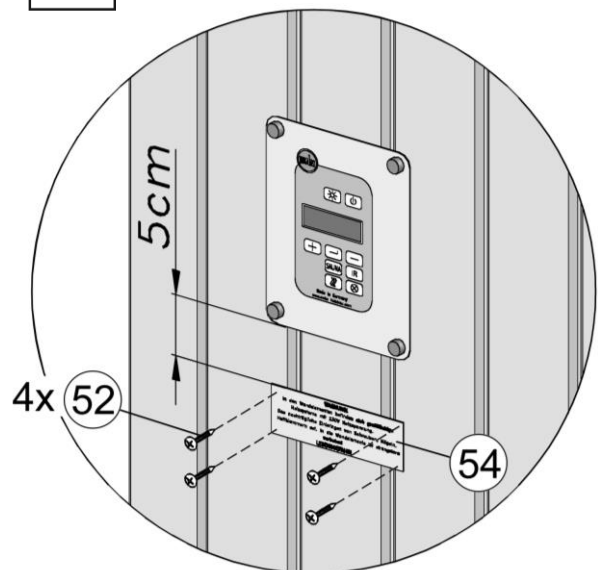

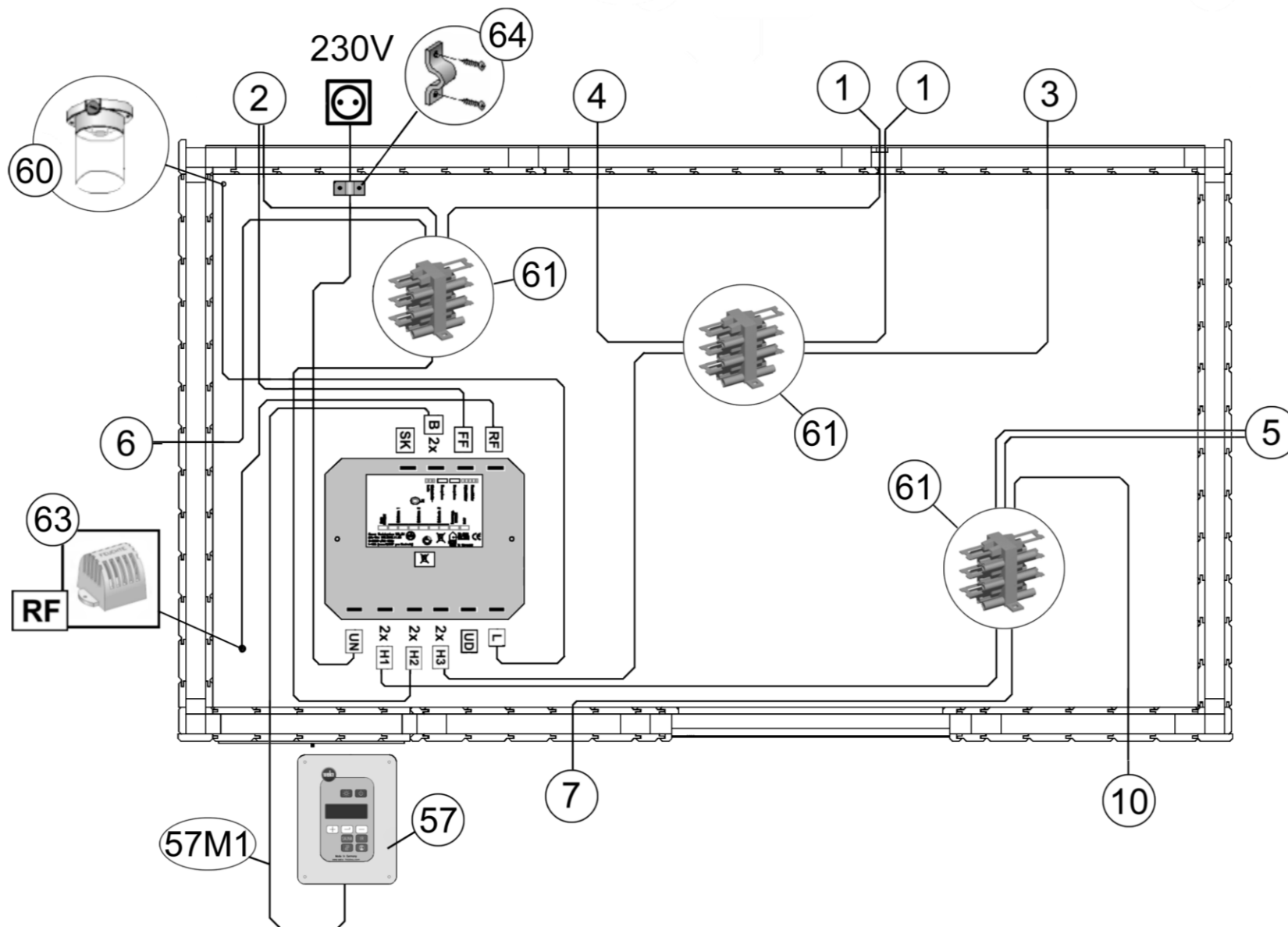



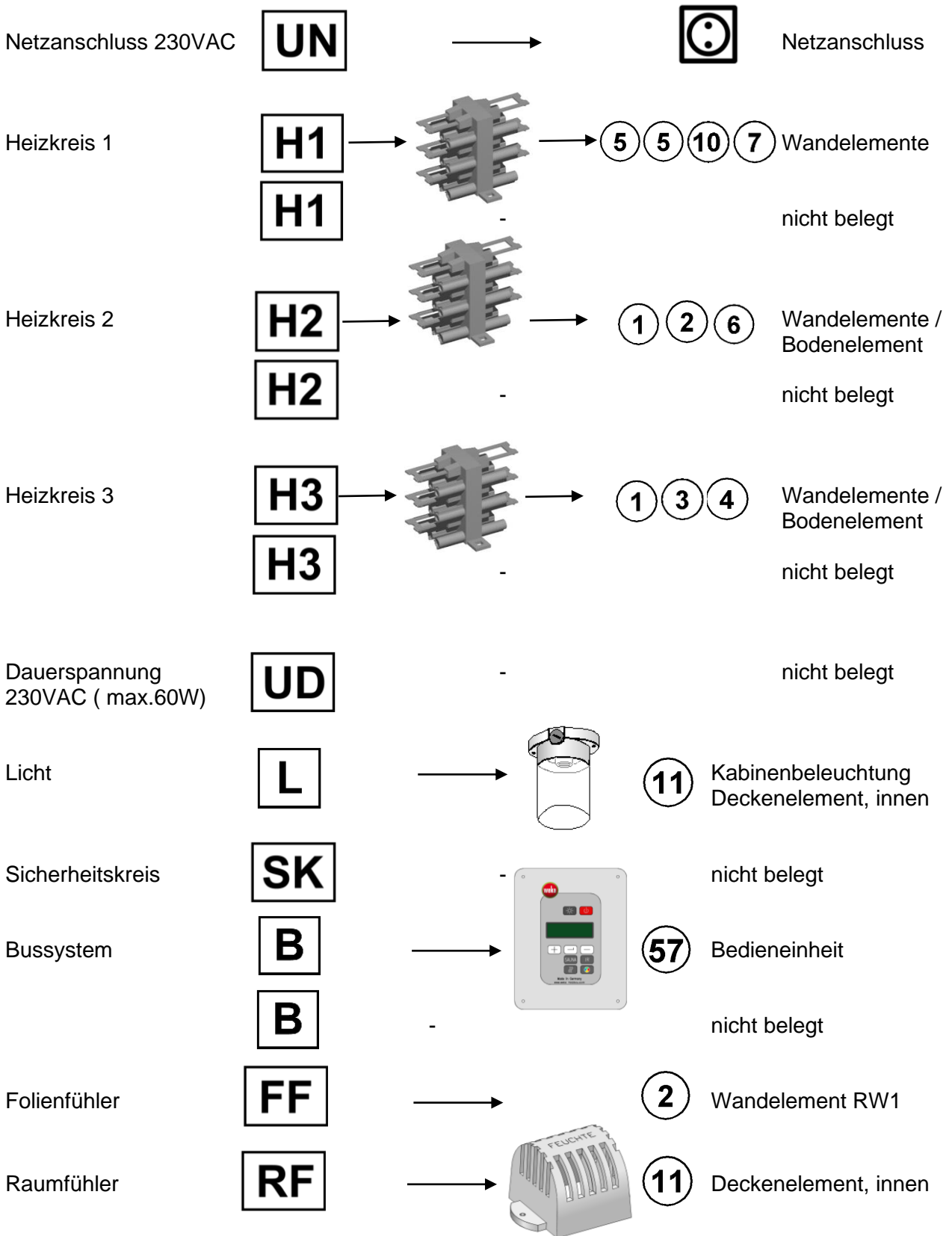

- de -

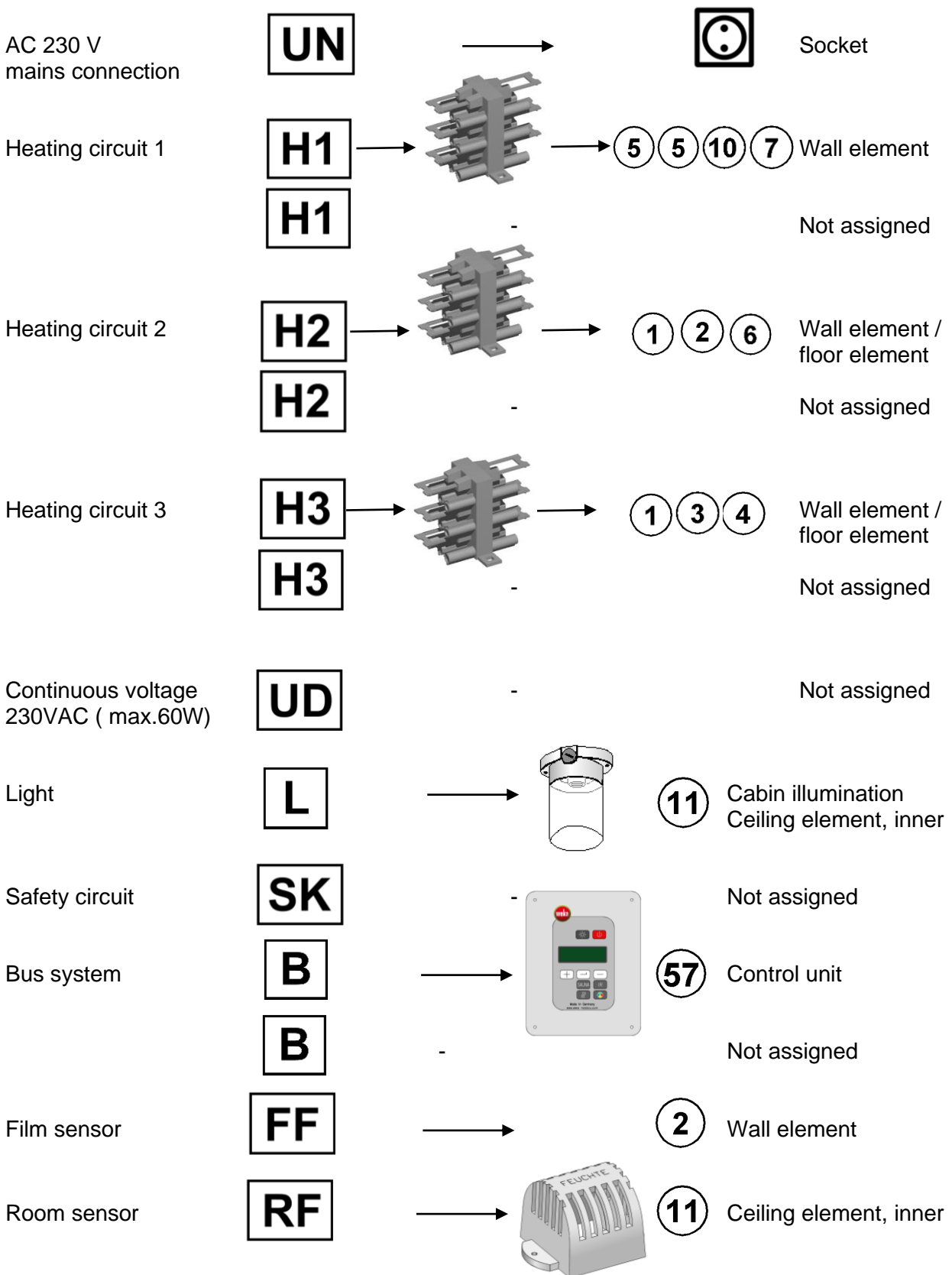

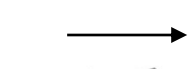
- en -

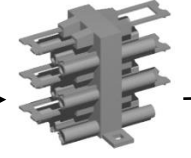
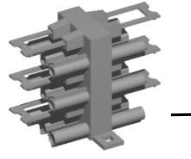
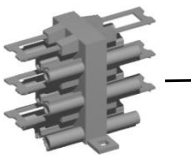
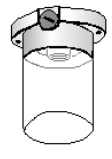

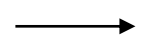
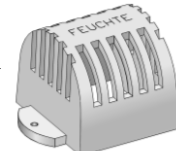
Raccordement secteur 230 VAC	UN			Prise
Circuit de chauffage 1	H1		5 5 10 7	Élément de paroi
	H1	-	-	Non affecté
Circuit de chauffage 2	H2		1 2 6	Élément de paroi / Élément de sol
	H2	-	-	Non affecté
Circuit de chauffage 3	H3		1 3 4	Élément de paroi / Élément de sol
	H3	-	-	Non affecté
Tension permanente 230VAC (max.60W)	UD	-	-	Non affecté
Lumière	L		11	Éclairage de la cabine Élément de plafond, intérieur
Circuit de sécurité	SK	-	-	Non affecté
Système de bus	B		57	Unité de commande
	B	-	-	Non affecté
Capteur film	FF		2	Élément de paroi
Capteur pièce	RF		11	Élément de plafond, intérieur

- it -

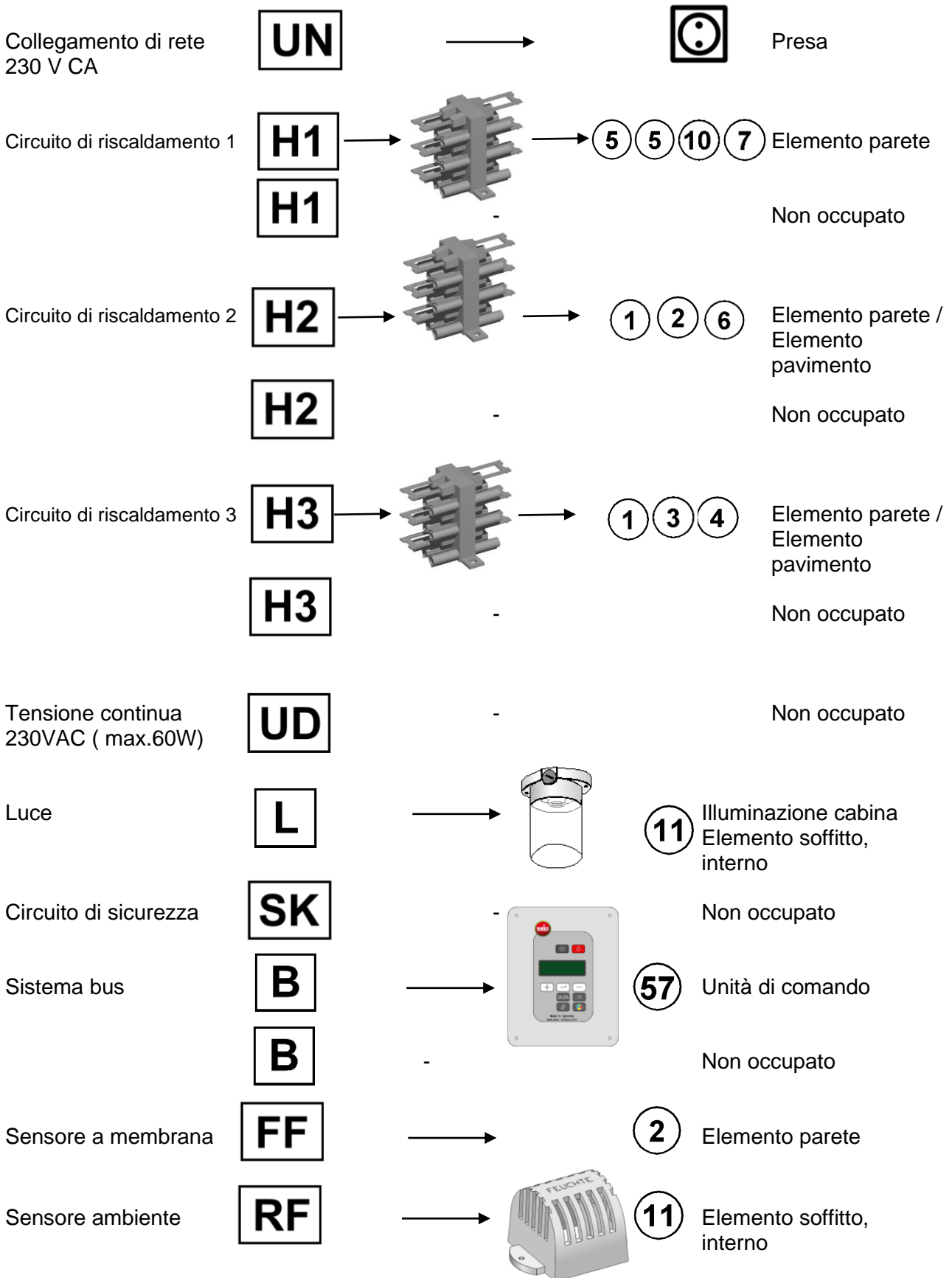

- nl -

aansluiting
op het stroomnet
230 V wisselstroom

UN

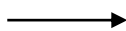

Stopcontact

Verwarmingcircuit 1

H1



→ (5) (5) (10) (7)

Wandelemente

H1



Geen functie

Verwarmingcircuit 2

H2

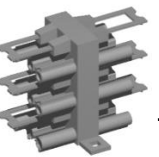

→ (1) (2) (6)

Wandelemente /
Vloerelement

H2



nicht belegt

Verwarmingcircuit 3

H3

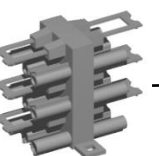

→ (1) (3) (4)

Wandelemente /
Vloerelement

H3



Geen functie

Continuspanning
230VAC (max.60W)

UD



Geen functie

Licht

L

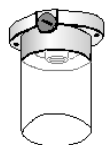

(11)

Cabineverlichting
Plafondelement, buiten

Veiligheidscircuit

SK



Geen functie

Bussystem

B



(57)

Bedieningseenheid

B



Geen functie

Folievoeler

FF



(2)

Wandelement RW1

Ruimtevoeler

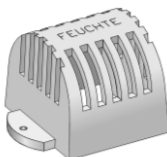

RF



(11)



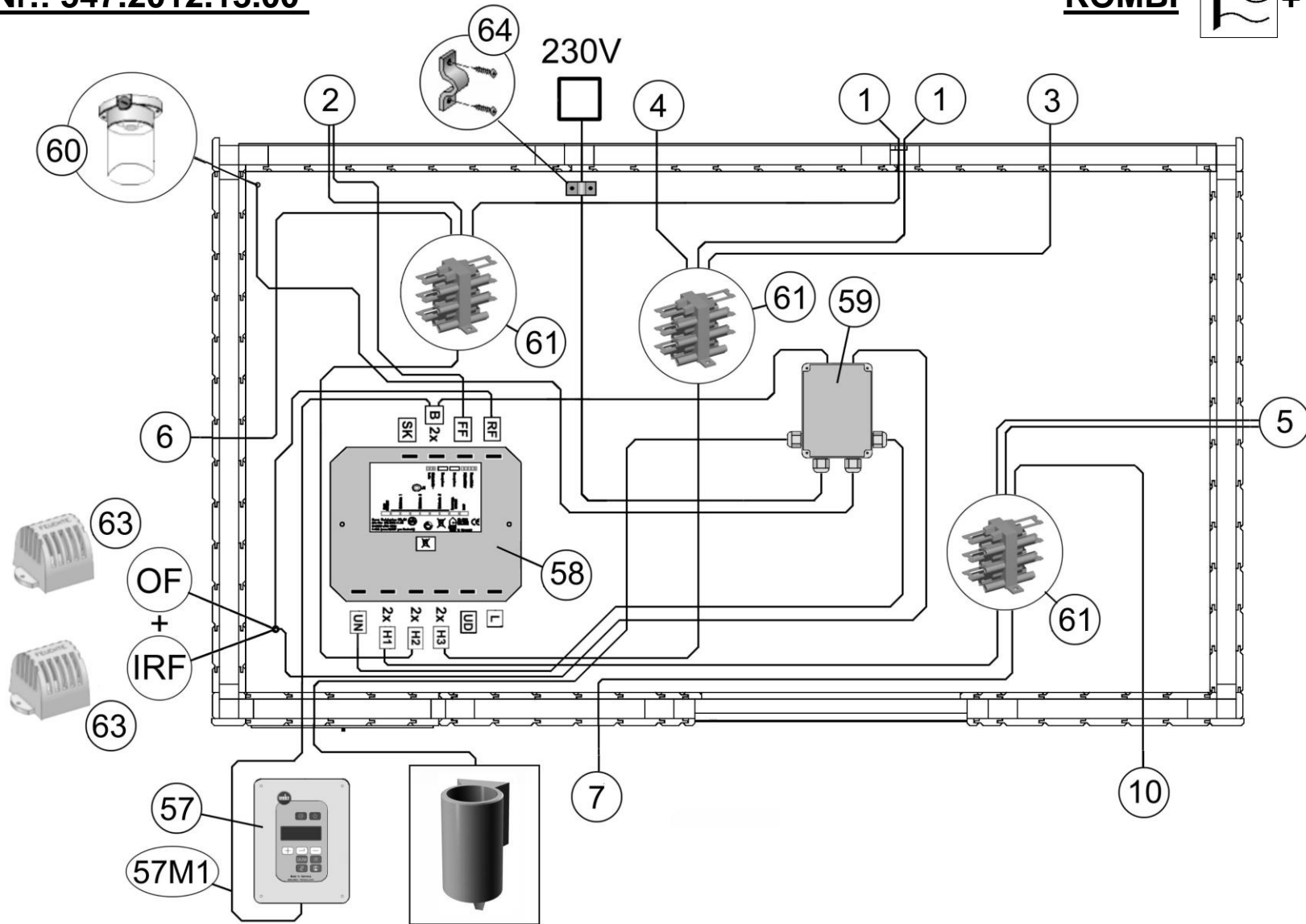

Plafondelement, binnen

19 Art.-Nr.: 547.2012.13.00



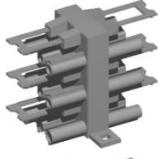
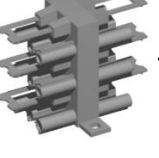
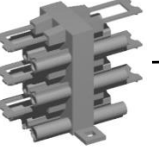

KOMBI  + 

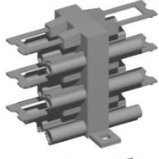
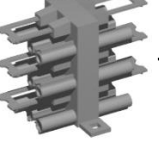
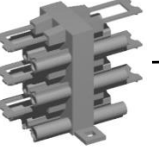

- de -

Netzanschluss 230VAC	UN	→		Festanschluss
Heizkreis 1	H1	→		⑤ ⑤ ⑩ ⑦ Wandelemente
	H1			
Heizkreis 2	H2	→		① ② ⑥ Wandelemente / Bodenelement
	H2			
Heizkreis 3	H3	→		① ③ ④ Wandelemente / Bodenelement
	H3			
Dauerspannung 230VAC (max.60W)	UD	-	-	nicht belegt
Licht	L	-	-	nicht belegt
Sicherheitskreis	SK	-	-	nicht belegt
Bussystem	B	→		⑤⑦ Bedieneinheit
	B			
Folienfühler	FF	→	②	Wandelement RW1
IR-Raumfühler	RF	→	⑪	Deckenelement, innen
Modul Ofensteuerung	⑤⑨	→		Netzanschluss
	⑤⑨	→		Saunaofen
	⑤⑨	→	⑪	Deckenelement, innen
	⑤⑨	→	⑪	Kabinenbeleuchtung Deckenelement, innen

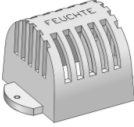
- en -

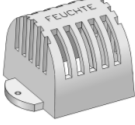
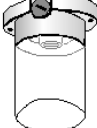



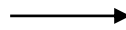

AC 230 V mains connection	UN	→		Socket	
Heating circuit 1	H1	→		→ (5) (5) (10) (7)	Wall element
	H1	-	-	-	Not assigned
Heating circuit 2	H2	→		→ (1) (2) (6)	Wall element / Bodenelement
	H2	-	-	-	Not assigned
Heating circuit 3	H3	→		→ (1) (3) (4)	Wall element / Bodenelement
	H3	-	-	-	Not assigned
Continuous voltage 230VAC (max.60W)	UD	-	-	-	Not assigned
Light	L	-	-	-	Not assigned
Safety circuit	SK	-	-	-	Not assigned
Bus system	B	→		(57)	Control unit
	B	-	-	-	Not assigned
Film sensor	FF	→	-	(2)	Wall element RW1
Room sensor	RF	→	(IRF) 	-	Ceiling element, inner
Oven control system module	(59)	→	-	-	 Socket
	(59)	→		-	Sauna furnace
	(59)	→	(OF) 	(11)	Ceiling element, inner
	(59)	→		(11)	Cabin illumination Ceiling element, inner

- fr -

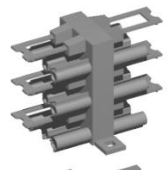
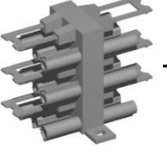
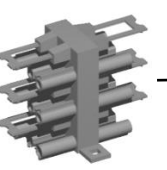

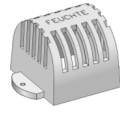

Raccordement secteur 230 VAC

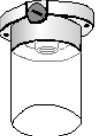



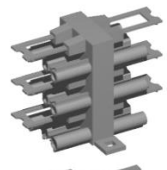
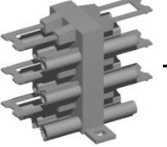
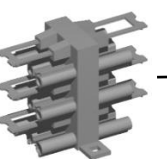

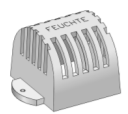
Prise

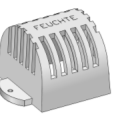
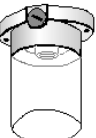
Circuit de chauffage 1	H1	→		→	5 5 10 7	Élément de paroi
	H1					Non affecté
Circuit de chauffage 2	H2	→		→	1 2 6	Élément de paroi / Élément de sol
	H2					Non affecté
Circuit de chauffage 3	H3	→		→	1 3 4	Élément de paroi / Élément de sol
	H3					Non affecté
Tension permanente 230VAC (max.60W)	UD		-			Non affecté
Lumière	L		-			Non affecté
Circuit de sécurité	SK					Non affecté
Système de bus	B	→			57	Unité de commande
	B					Non affecté
Capteur film	FF	→			2	Élément de paroi RW1
Capteur pièce	RF	→	IRF 		11	Élément de plafond, intérieur
Module Commande du poêle	59	→				Prise
	59	→				poêle de sauna
	59	→	OF 		11	Élément de plafond, intérieur
	59	→			11	Éclairage de la cabine Élément de plafond, intérieur

- it -

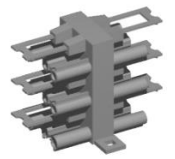
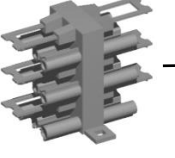
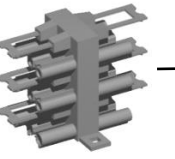
Collegamento di rete 230 V CA	UN	→		Presa
Circuito di riscaldamento 1	H1	→		→ (5) (5) (10) (7) Elemento parete
	H1	-	-	Non occupato
Circuito di riscaldamento 2	H2	→		→ (1) (2) (6) Elemento parete / Elemento pavimento
	H2	-	-	Non occupato
Circuito di riscaldamento 3	H3	→		→ (1) (3) (4) Elemento parete / Elemento pavimento
	H3	-	-	Non occupato
Tensione continua 230VAC (max.60W)	UD	-	-	Non occupato
Luce	L	-	-	Non occupato
Circuito di sicurezza	SK	-	-	Non occupato
Sistema bus	B	→		(57) Unità di comando
	B	-	-	Non occupato
Sensore a membrana	FF	→	-	(2) Elemento parete RW1
Sensore ambiente	RF	→	(IRF) 	(11) Elemento soffitto interno
Modulo comando forno	(59)	→		Presa
	(59)	→		stufa per sauna
	(59)	→	(OF) 	(11) Elemento soffitto, interno
	(59)	→		(11) Illuminazione cabina Elemento soffitto, interno

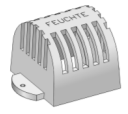
- nl -

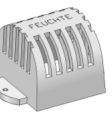
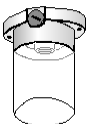
aansluiting op het stroomnet 230 V wisselstroom	UN	→		Stopcontact
Verwarmingscircuit 1	H1	→		→ (5) (5) (10) (7) Wandelemente
	H1			Geen functie
Verwarmingscircuit 2	H2	→		→ (1) (2) (6) Wandelemente / Vloerelement
	H2			Geen functie
Verwarmingscircuit 3	H3	→		→ (1) (3) (4) Wandelemente / Vloerelement
	H3			Geen functie
Continuspanning 230VAC (max.60W)	UD		-	Geen functie
Licht	L		-	Geen functie
Veiligheidscircuit s	SK		-	Geen functie
Bussystem	B	→		(57) Bedieningseenheid
	B			Geen functie
Folievoeler	FF	→		(2) Wandelement RW1
Ruimtevoeler	RF	→	(IRF) 	(11) Plafondelement, binnen
Modul Saunaoven	(59)	→		 Netaansluiting
	(59)	→		Saunaoven
	(59)	→	(OF) 	(11) Plafondelement, binnen
	(59)	→		(11) Cabineverlichting Plafondelement, buiten

20

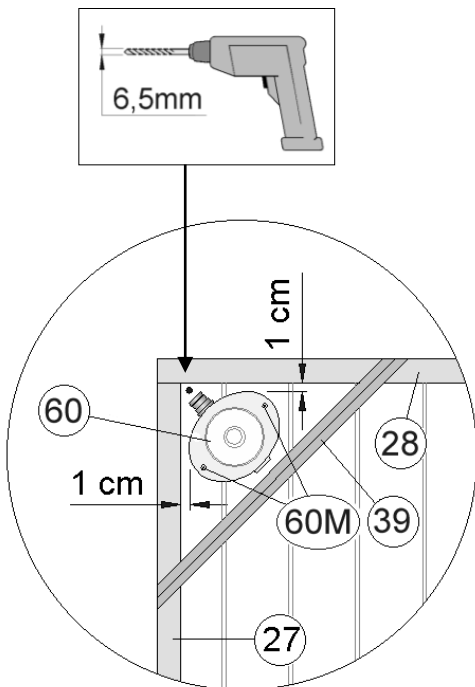
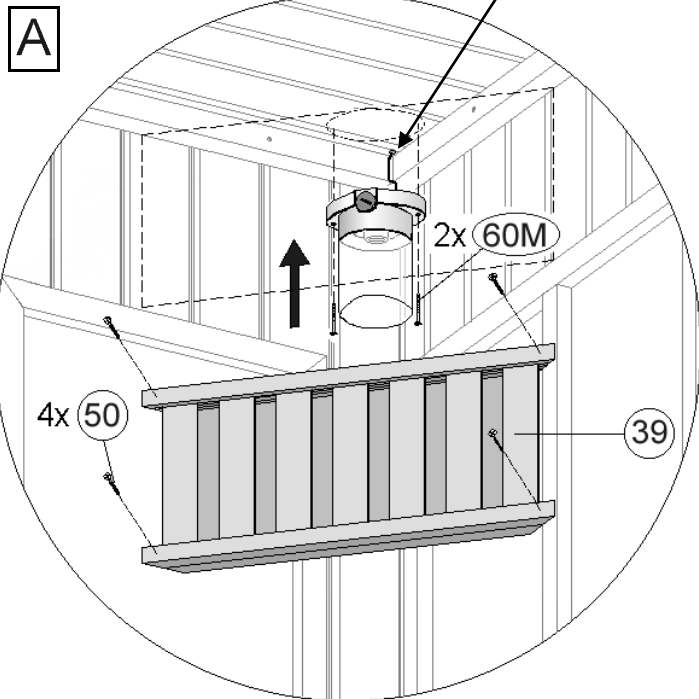
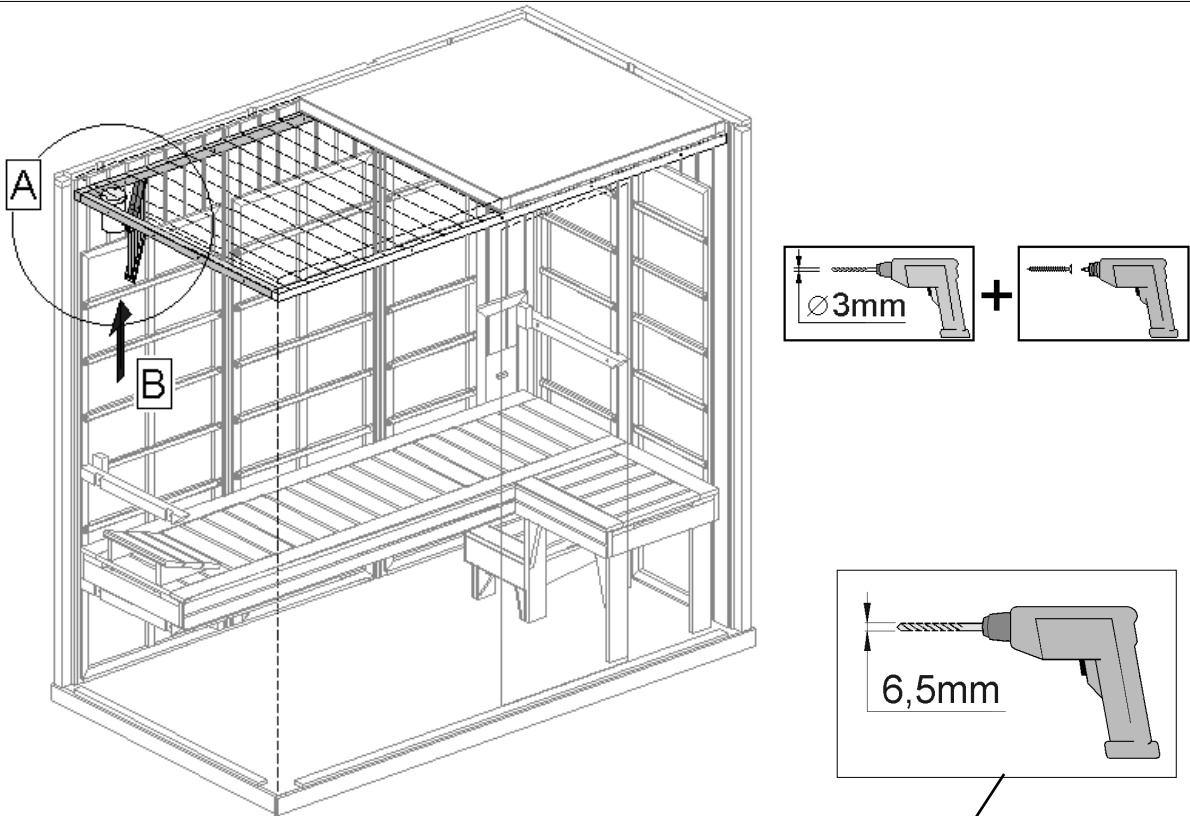
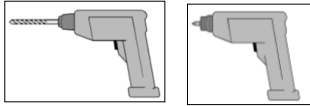

21

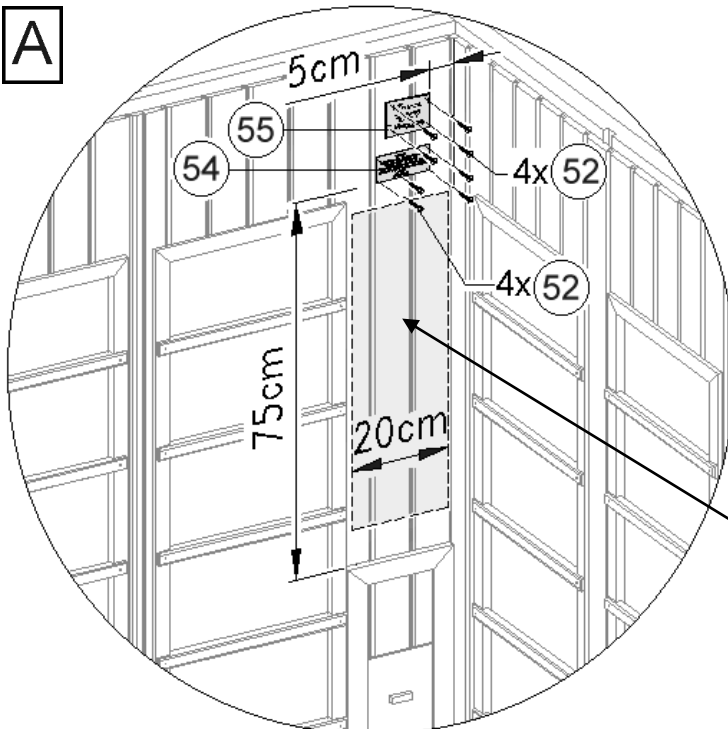
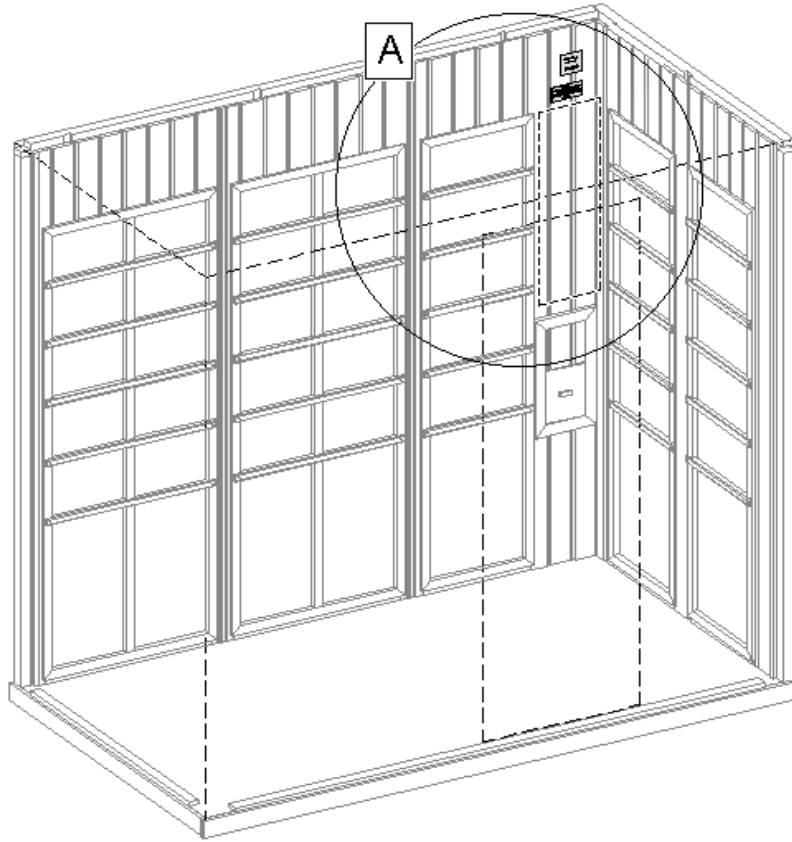
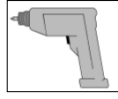
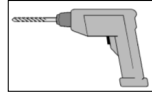
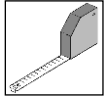

de	Bereich zur Befestigung von Zubehör wie Klimamesser o.ä.
en	Area for attachment of accessories such as climate meter etc.
fr	Zone de fixation des accessoires tels que dispositif de mesure climatique et autres.
it	Area per il fissaggio di accessori come il misuratore della temperatura o similar
nl	Gebied voor het bevestigen van accessoires zoals klimaatmeter o.i.d.

22

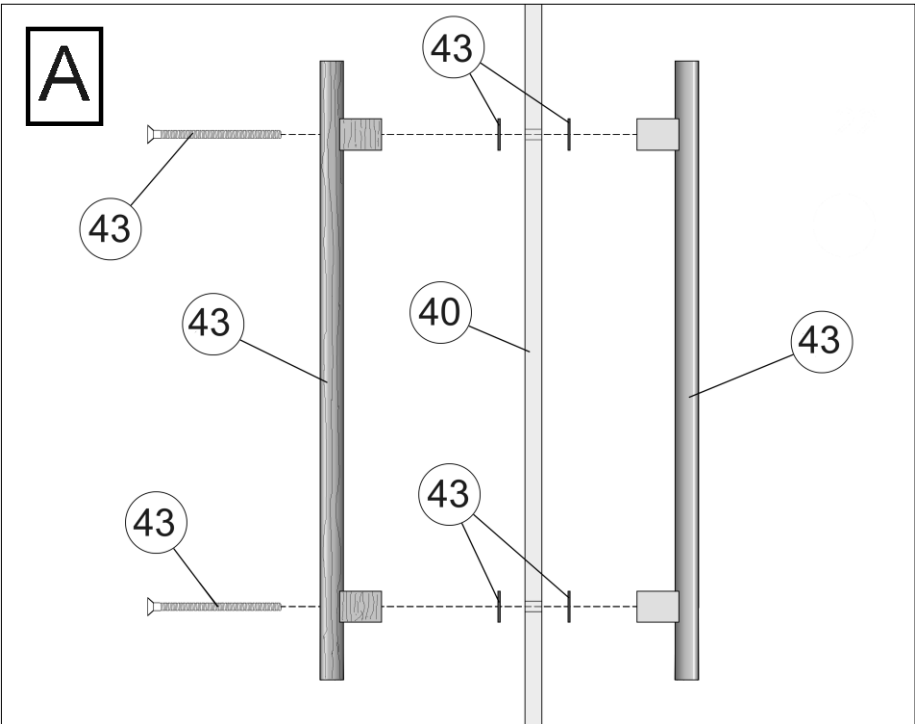
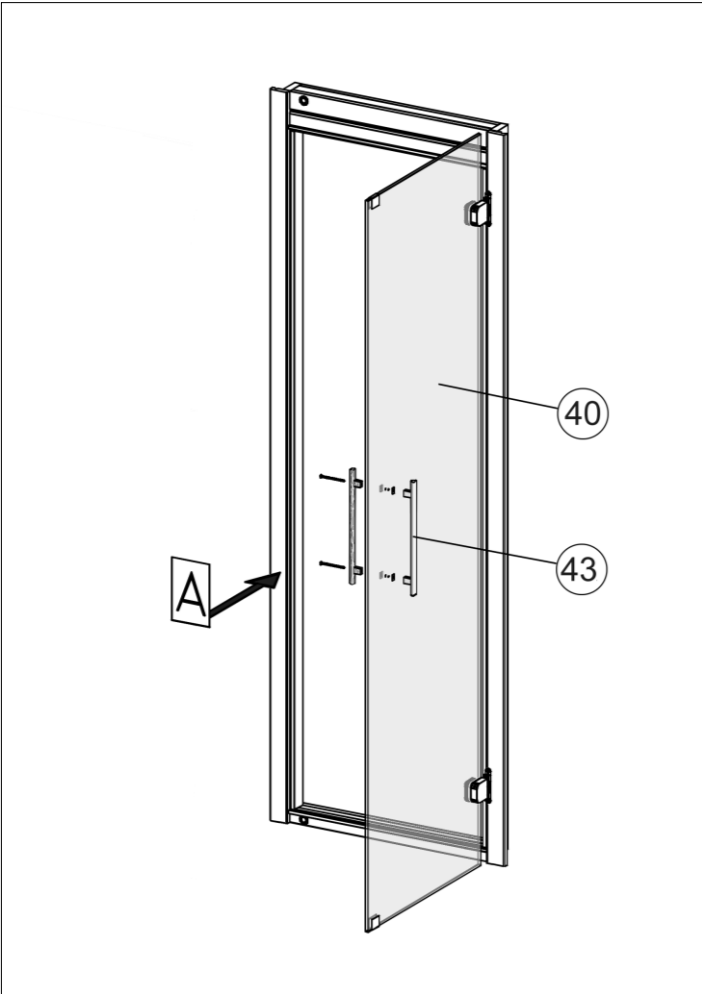
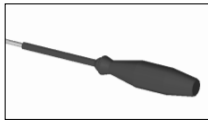

**EG – Konformitätserklärung
EU – Declaration of Conformity**



Hiermit erklären wir, dass das nachfolgend bezeichnete Gerät den einschlägigen EG-Richtlinien (insbesondere den unten benannten) entspricht und die Serie entsprechend gefertigt wird.

We herewith confirm that the appliance below complies with the governing EU-directives (in particular with those directives mentioned below) and bulk production will be manufactured accordingly.

Artikelbezeichnung: INFRAROT WÄRMEKABINE (IR-Kabine) in Elementbauweise	
article description	
Artikelnummer:	547.2012.03.xx
article number	
Type	IR-C weka-Therm-FLÄCHENSTRAHLER- KABINE MIT DIGITALER STEUERUNG
Baureihe:	547
Model	
Model	2012.03
Technische Daten : 230V / 50Hz / 16A, max. elektr. Einschaltleistung 3336 W	
Technical data	
Beleuchtung max. 40 W / 230 V , Standby 1,5 W	
Sonstige Angaben : Schutzklasse I	
Further details	

Einschlägige EG-Richtlinien / Governing EC Directives / Directives CE concernées:

- Elektromagnetische Verträglichkeit (EMV); electromagnetic compatibility (EMC) 2004/108/EC
- Niederspannungsrichtlinien; low-voltage standards 2006/95/EC
- Sicherheit von Spielzeug; Safety standards of toys 88/378/EEC amended 93/68/EEC
- Medizinprodukte (Klasse 1); Medical device directives (Class 1) 93/42/EEC
- Ökodesign-Richtlinie; Energy related products directive (ErP) 2009/125/EC
- Verordnung über Materialien und Gegenstände, die dazu bestimmt sind, mit Lebensmitteln in Berührung zu kommen; Regulation on materials and articles intended to come into contact with food 1935/2004/EC
- Richtlinie 2011/65/EU (RoHS), w/o electronic parts
-

Harmonisierte EN-Normen / Harmonized EN-standards:

EN 60335-1 : 2010;EN 60335-2-53 : 2007;E EN 60335-2-53 : 2011;EN 55011 : 2007;EN 61000-3-2/A2 : 2009;
EN 61000-3-3 : 2008; EN 61000-6-1 : 2007;EN 61000-6-2 : 2005;EN 61000-6-3 : 2007;EN 61000-6-4 : 2007;
EN 61000-4-2 : 2009;EN 61000-4-3 : 2008;EN 61000-4-4 : 2004;EN 61000-4-5 : 2007;EN 61000-4-6 : 2009;
EN 61000-4-11 : 2005;EN 55014-1/A2 : 2011;EN 55014-2/A2: 2008;DIN EN 60238 (VDE 0616 Teil 1) :2009;
EN 60238 : 2008; DIN EN 62321:2009

Neubrandenburg 27. Dezember 2013
Datum/date



Unterschrift/sign
Geschäftsführer (Frank Albertsmeier)

Archivierung / For archives

EG – Konformitätserklärung
EU – Declaration of Conformity



Hiermit erklären wir, dass das nachfolgend bezeichnete Gerät den einschlägigen EG-Richtlinien (insbesondere den unten benannten) entspricht und die Serie entsprechend gefertigt wird.

We herewith confirm that the appliance below complies with the governing EU-directives (in particular with those directives mentioned below) and bulk production will be manufactured accordingly.

Artikelbezeichnung: Kombinierte INFRAROT-SAUNA WÄRMEKABINE (IRS-Kabine) in Elementbauweise article description
Artikelnummer: 547.2012.30.xx article number
Type IR-C weka-Therm-FLÄCHENSTRAHLER- und SAUNA KABINE MIT DIGITALER STEUERUNG
Baureihe: 547 Model 2012.30
Technische Daten : IR/Sauna 230V / 50Hz / 16A, max. elektr. Einschaltleistung 3336 W / 3600 W Technical data Beleuchtung max. 40 W / 230 V , Standby 1,5 W
Sonstige Angaben : Schutzklasse I Further details

Einschlägige EG-Richtlinien / Governing EC Directives / Directives CE concernées:

- Elektromagnetische Verträglichkeit (EMV); electromagnetic compatibility (EMC) 2004/108/EC
- Niederspannungsrichtlinien; low-voltage standards 2006/95/EC
- Sicherheit von Spielzeug; Safety standards of toys 88/378/EEC amended 93/68/EEC
- Medizinprodukte (Klasse 1); Medical device directives (Class 1) 93/42/EEC
- Ökodesign-Richtlinie; Energy related products directive (ErP) 2009/125/EC
- Verordnung über Materialien und Gegenstände, die dazu bestimmt sind, mit Lebensmitteln in Berührung zu kommen; Regulation on materials and articles intended to come into contact with food 1935/2004/EC
- Richtlinie 2011/65/EU (RoHS), w/o electronic parts
-

Harmonisierte EN-Normen / Harmonized EN-standards:

EN 60335-1 : 2010;EN 60335-2-53 : 2007;E EN 60335-2-53 : 2011;EN 55011 : 2007;EN 61000-3-2/A2 : 2009;
EN 61000-3-3 : 2008; EN 61000-6-1 : 2007;EN 61000-6-2 : 2005;EN 61000-6-3 : 2007;EN 61000-6-4 : 2007;
EN 61000-4-2 : 2009;EN 61000-4-3 : 2008;EN 61000-4-4 : 2004;EN 61000-4-5 : 2007;EN 61000-4-6 : 2009;
EN 61000-4-11 : 2005;EN 55014-1/A2 : 2011;EN 55014-2/A2: 2008;DIN EN 60238 (VDE 0616 Teil 1) :2009;
EN 60238 : 2008; DIN EN 62321:2009

Neubrandenburg 27. Dezember 2013
Datum/date

Unterschrift/sign
Geschäftsführer (Frank Albertsmeier)

Archivierung / For archives

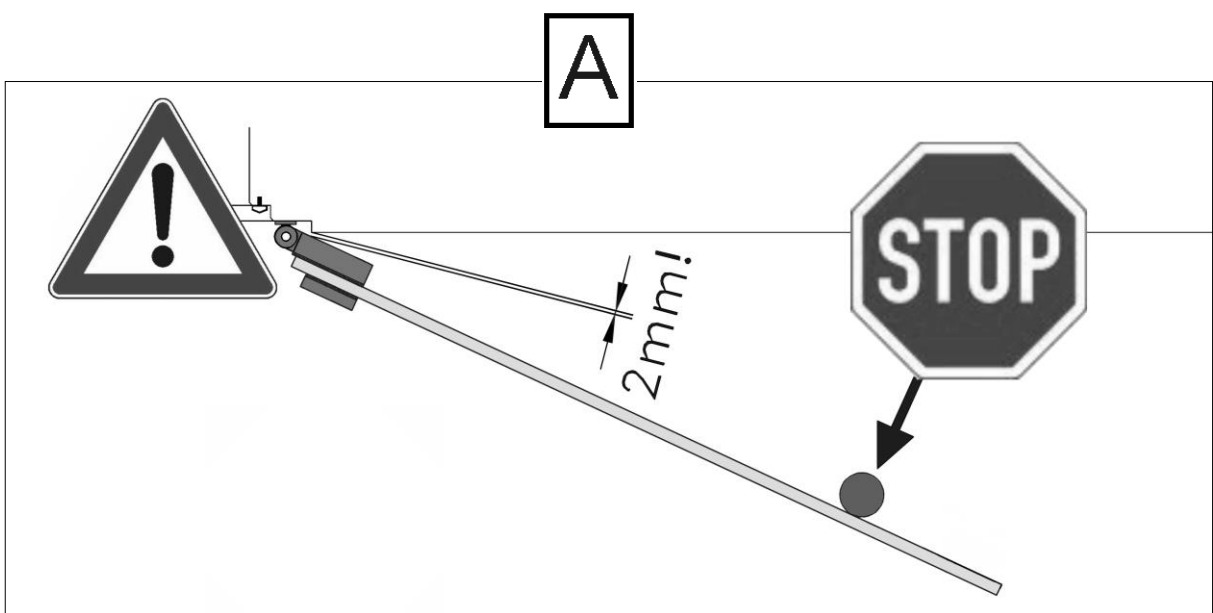
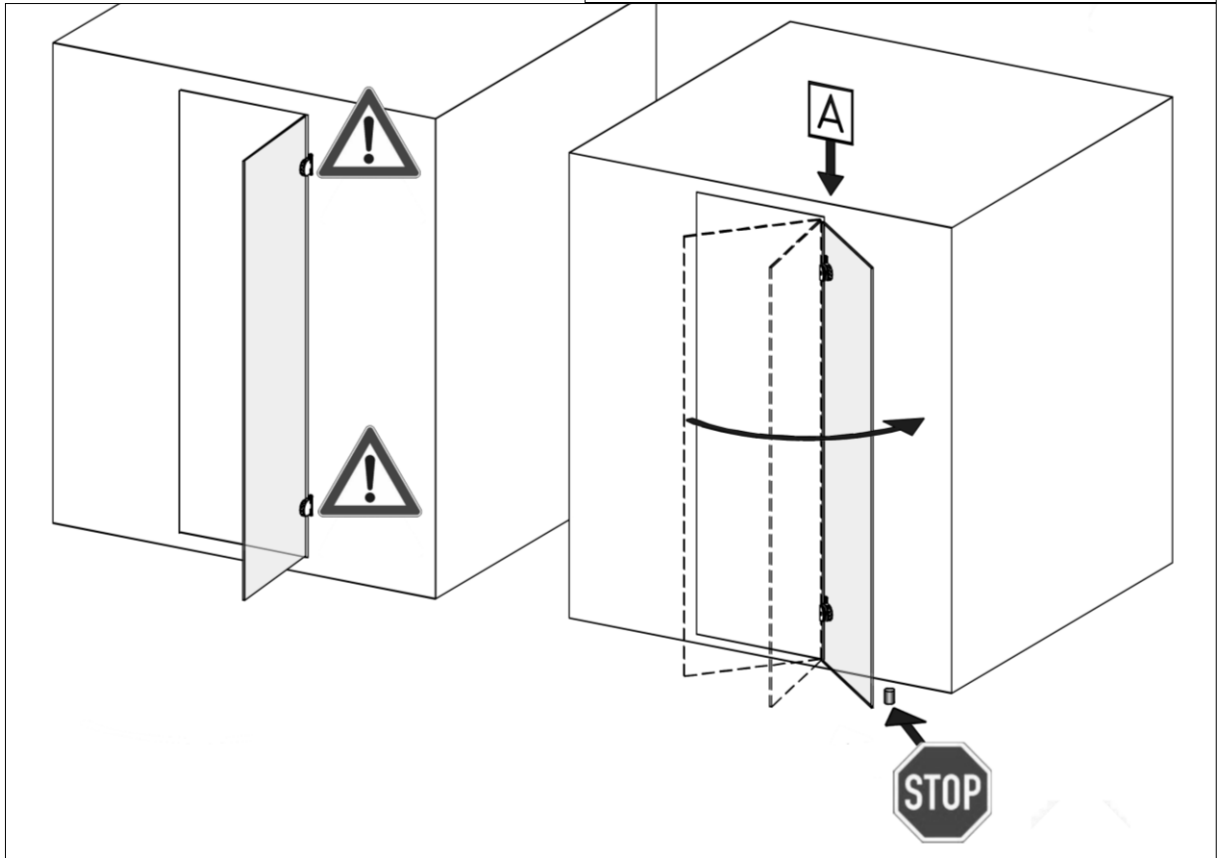
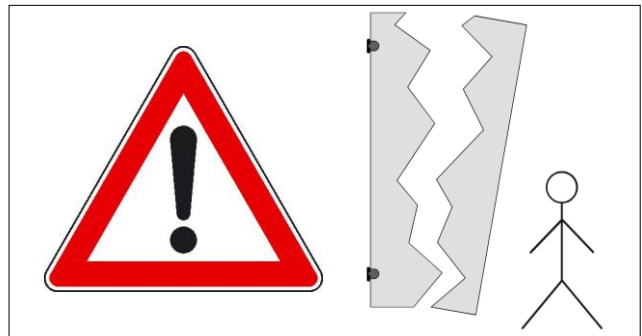
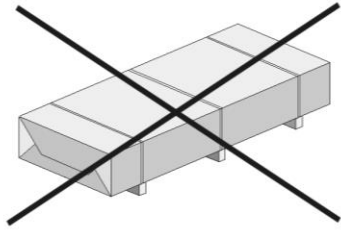



**weka Holzbau GmbH,
Johannesstr. 16
D-17034 Neubrandenburg
Tel. : +49 (0)395 42908-0
Fax : +49 (0)395 42908-83**

MA Art.-Nr.: 800.0286.22.06