

18
mm



PROD.Nr.:



1415

Gartenpro Kft.
9444 Fertőszentmiklós
Soproni úti ipartelep
HUNGARY
16
1415-CPR-43-(C-80/2015)
ETA-15/0873
ETAG 007







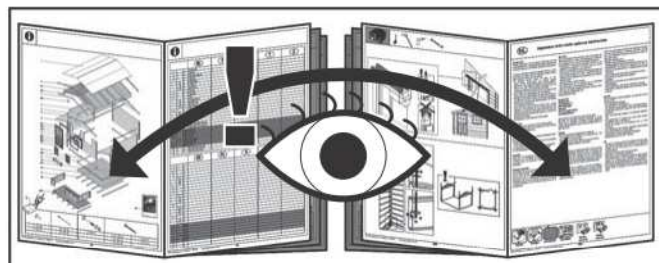

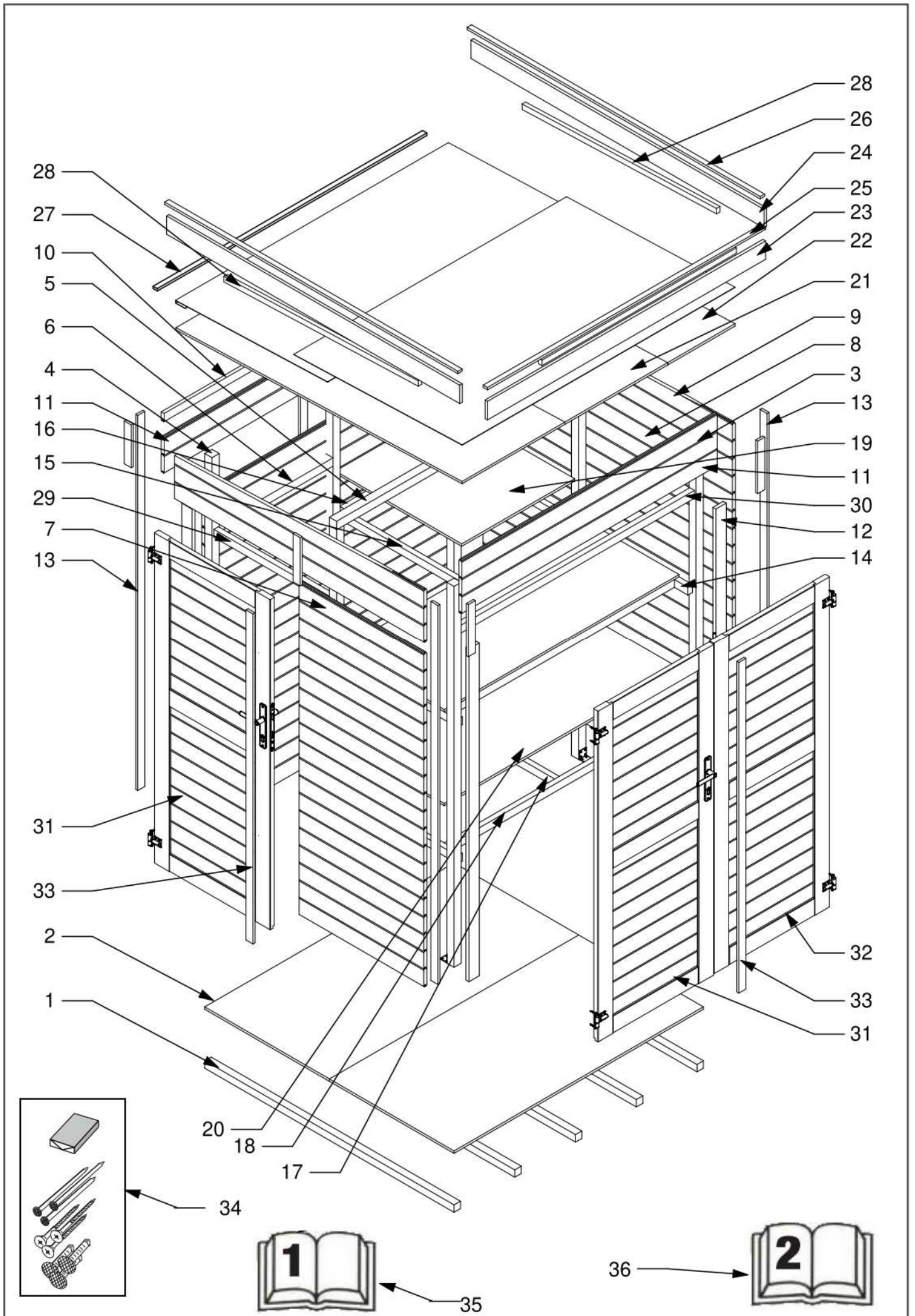



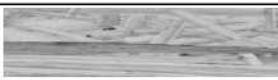

















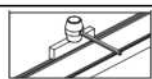













GARDENWARDROBE 1515 18 F1R0B1
Art.Nr. G1815151
Ean.Nr.:5999553063219

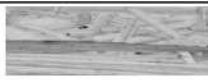

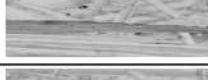



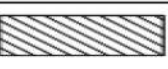











Hout voor Outdoor Life Products blokhutten en tuinhuizen is vooral afkomstig uit gecertificeerde en goed beheerde bossen.
Wood used for our Outdoor Life Products cabins and garden houses is mostly sourced from certified and well-managed forests.
Das Holz für Outdoor Life Products Blockbohlenhäuser und Gartenhäuser wird größtenteils aus zertifizierten Wäldern bezogen.
Les bois pour chalets et maisons de jardin de Outdoor Life Products proviennent en grande partie de forêts certifiées et gérées durablement.

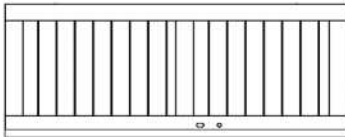
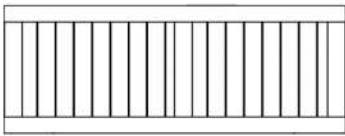









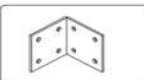
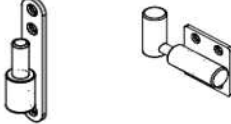

1.	G38381480	 	38x38x1480	5X
2.	G7401480		12x740x1480 OSB	2X
3.	G43431960	 	43x43x1960	2X
4.	G43431903	 	43x43x1903	5X
5.	G43431480	 	43x43x1480	1X
6.	G4343675	 	43x43x675	1X
7.	G1898740	 	18x98x740	19X
8.	G18981480	 	18x98x1480	42X
9.	G18981480S	 	18x98x1480	2X
10.	G18451516	 	18x45x1516N	1X
11.	G18981516	 	18x98x1516	5X
	G5157074	 	18X98X740	2X
12.	G18611710	 	18x61x1710	3X
13.	G2222473	 	12x42x1950	8X
14.	G2740700	 	27,6x40x700	4X
15.	G2740750	 	27,6x40x750	2X
16.	G2740617	 	27,6x40x617	2X
17.	G2740564	 	27,6x40x564	2X
18.	G27401338	 	27,6x40X1338	4X
19.	G670750		12x670x750	1X
20.	G6201390		12x620x1390	2X
21.	G2224665		12x610x1770	2X
22.	G4001770		12x400x1770	1X
23.	G15951650	 	15x95x1650	1X
24.	G2222866	 	15x95x1740	2X
25.	G60147540-1650	 	12x26x1650	1X

26.	G60147540-1740			12X26X1740	2X
27.	G60147540-1600			12x26x1600	1X
28.	G2227417			20,6x27,6x1155	3X
29.	G2740697			27,6x40x697	1X
30.	G27401394			27,6x40x1394	1X
31.	G6881699Z			Lap 688x1699_NP_Z (HP2153)	2X
32.	G6881699Ü			Lap 688x1699_NP_Ü (HP2181)	1X
33.	G2222672			12x42x1699	2X
34.	G2230436			KellCs. Szekrény 1515	1X
35.	G6099908		Building instr.	Útm. Építési	1X
36.	G6065190		General Conditions	Útm. Általános	1X

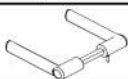
G2230436

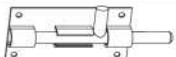
a	G60146097		3,5x25 mm	85X
b	G60124056		3,5x35 mm	560X
c	G60146093		4,0x60 mm	30X
d	G60146094		6,0x80 mm	8X
e	G60146117		40x40x40	7X
f	G682368			6X
g	G688162		Zár MIDI7 Cil+ütk.lem	2X
h	G682221		Cilinder 62 mm	2X
i	G688254K		Kilincs 410 F1	2X
j	G688254C		Cím EL74/90 MIDI Cilinderes	2X
k	G60146052		Tolózár 100 mm bajonett	2X

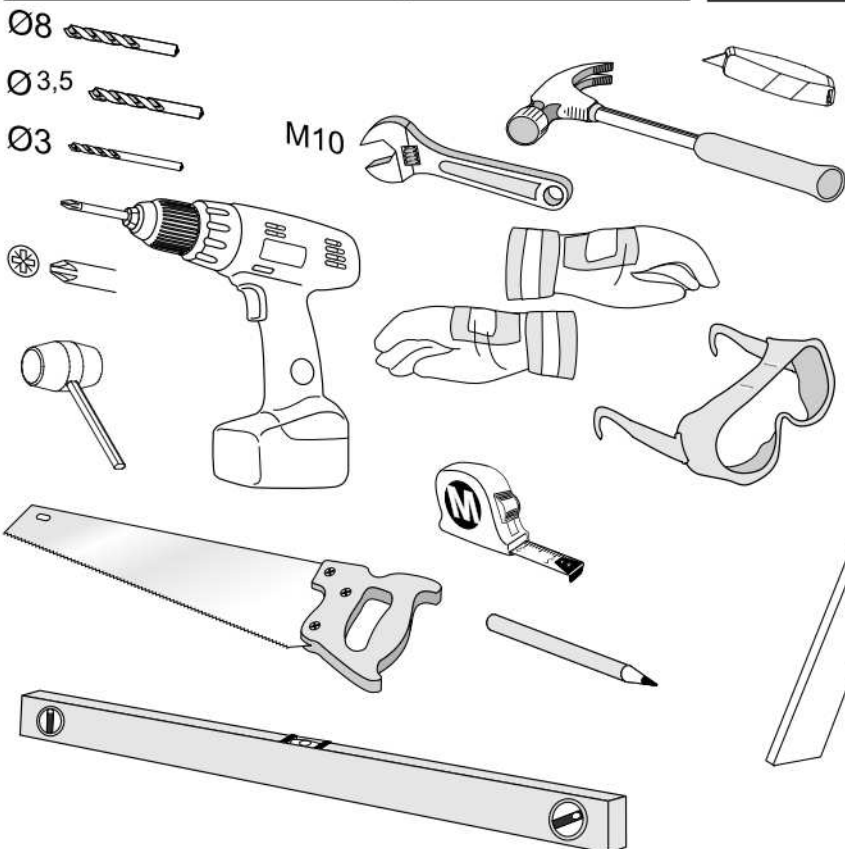
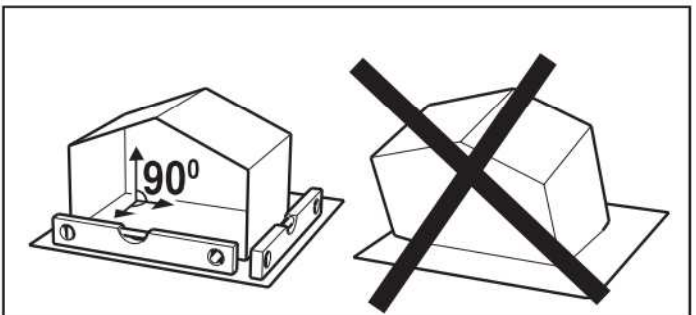
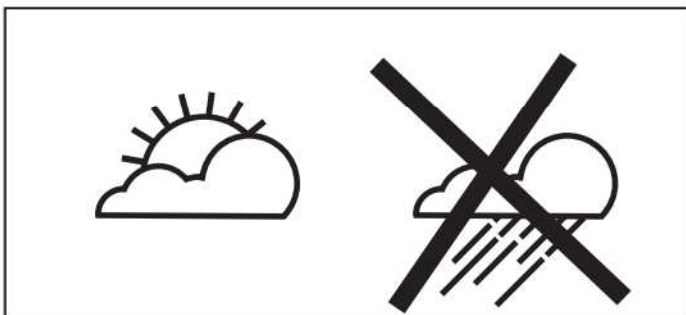
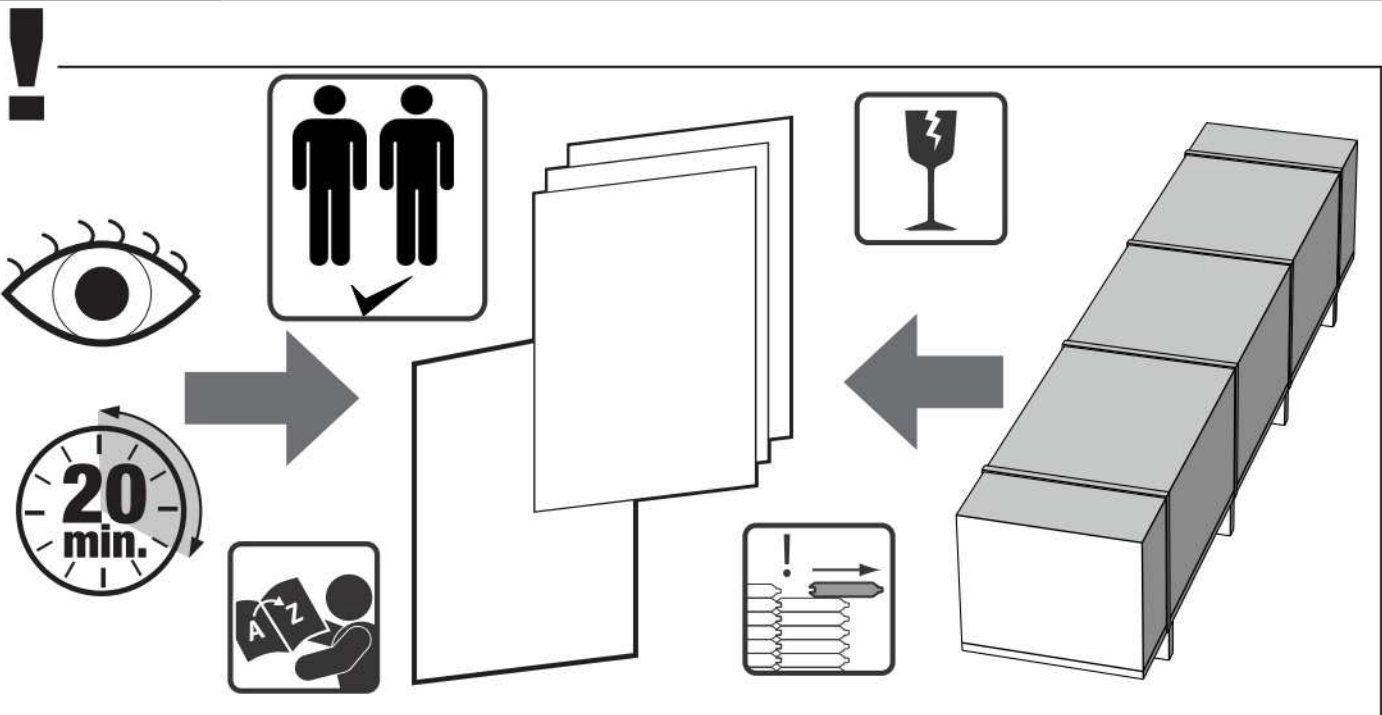
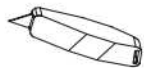
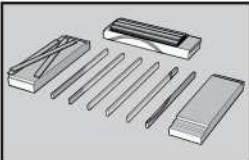

1

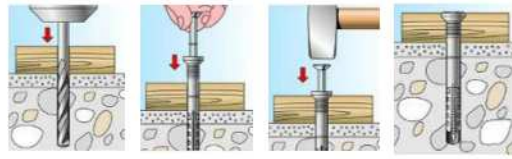
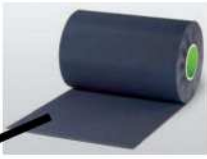
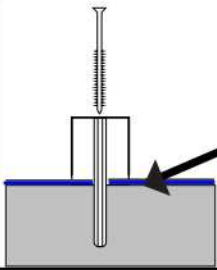

POS

1  38x38x1480 5X

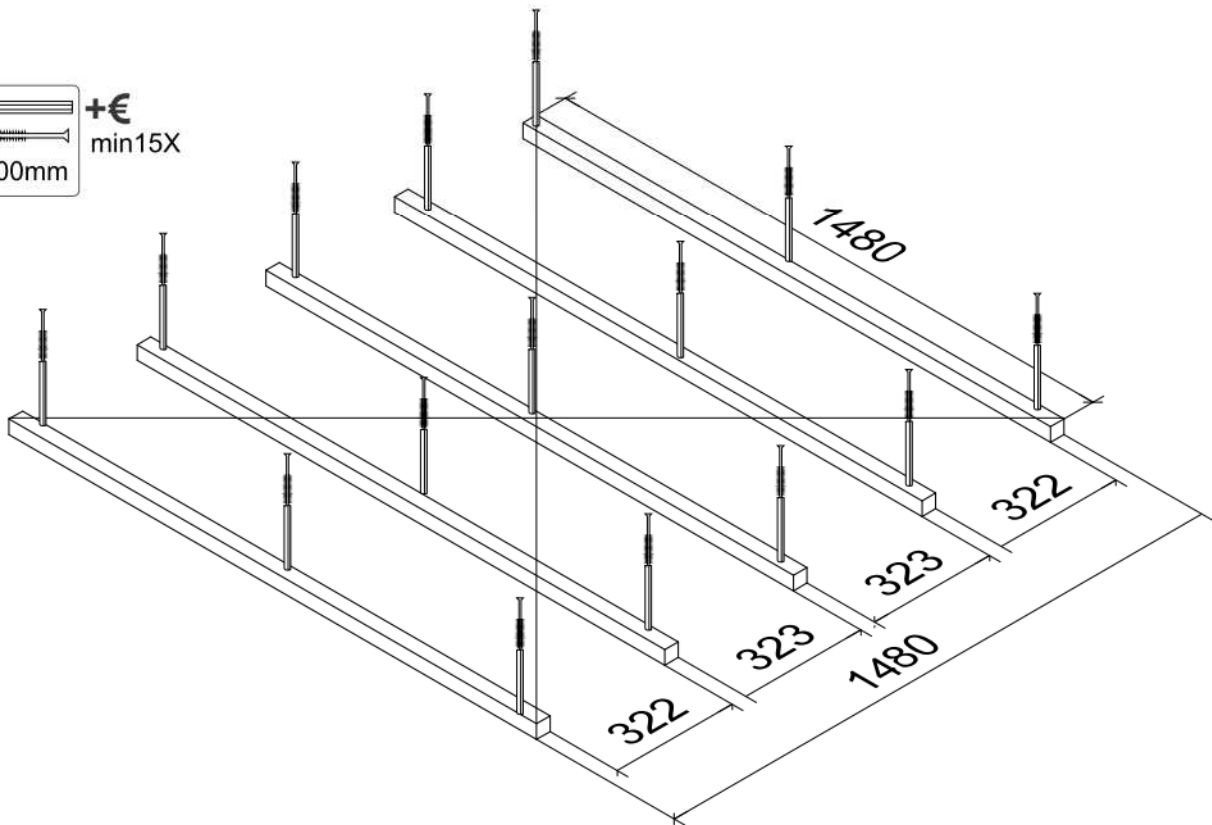
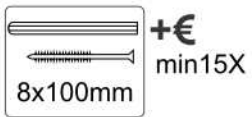
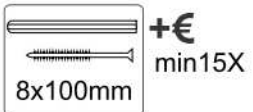

2

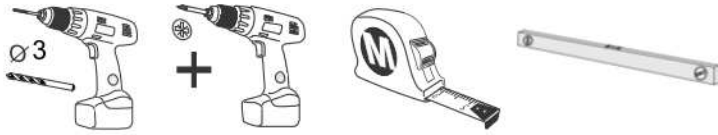

POS

2  12x740x1480 2X

 30X
3,5x35mm

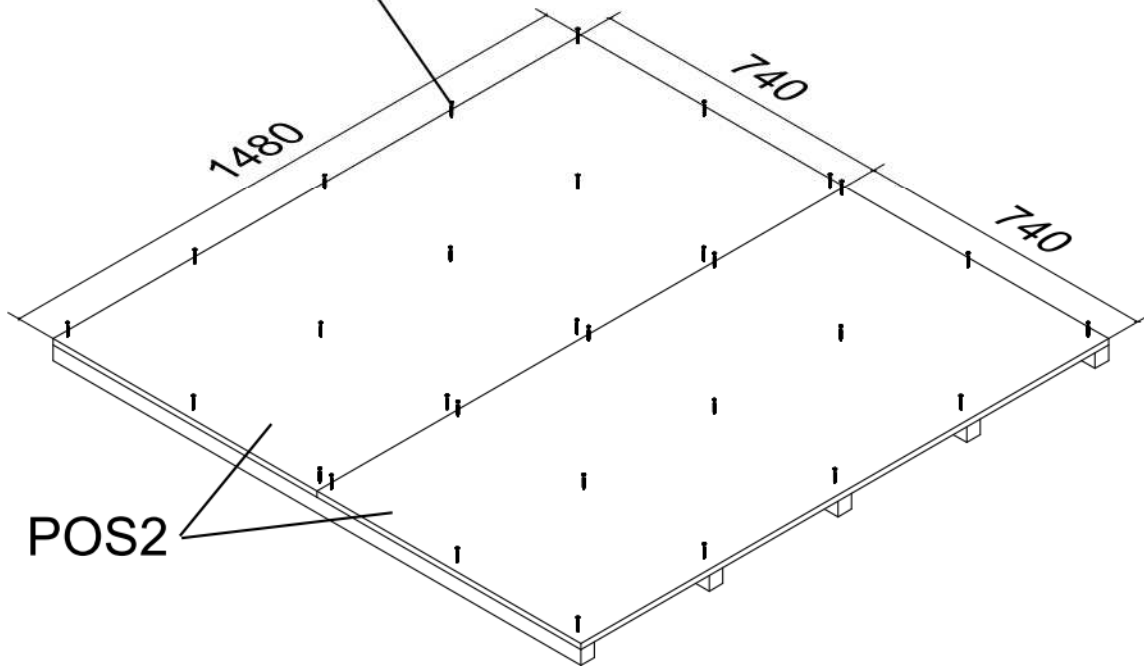
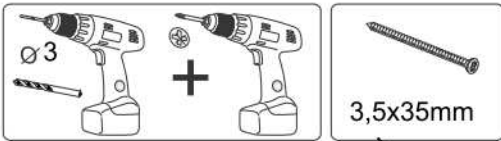

3

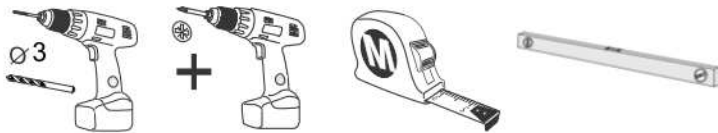

POS

3  43x43x1960 2X

4  43x43x1903 5X

 28X  7X

3,5x35mm

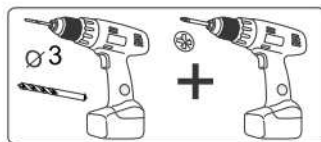

3,5x35mm

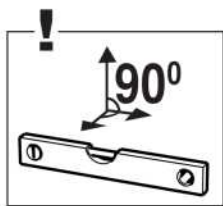
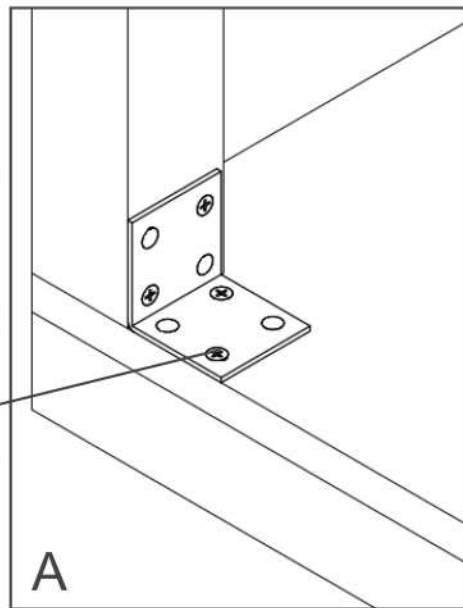

POS4

POS3

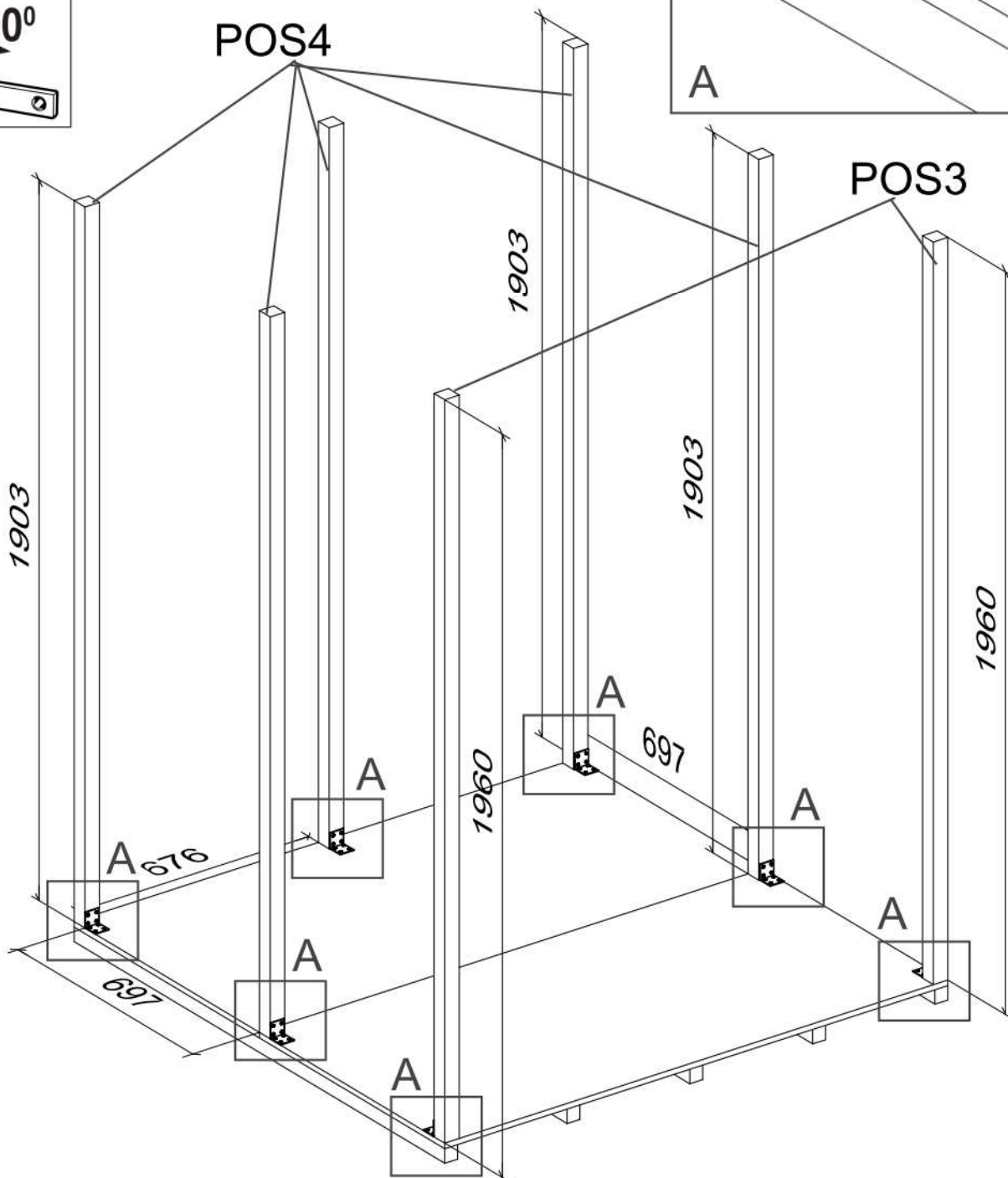

4

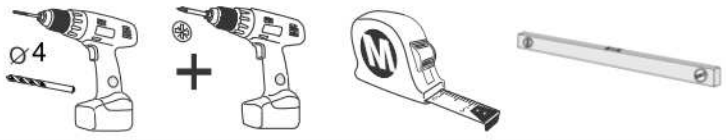

POS

5  43x43x1480 1X

6  43x43x675 1X

29  27,6x40x697 1X

30  27,6x40x1394 1X

 8X
5x80mm



 5x80mm

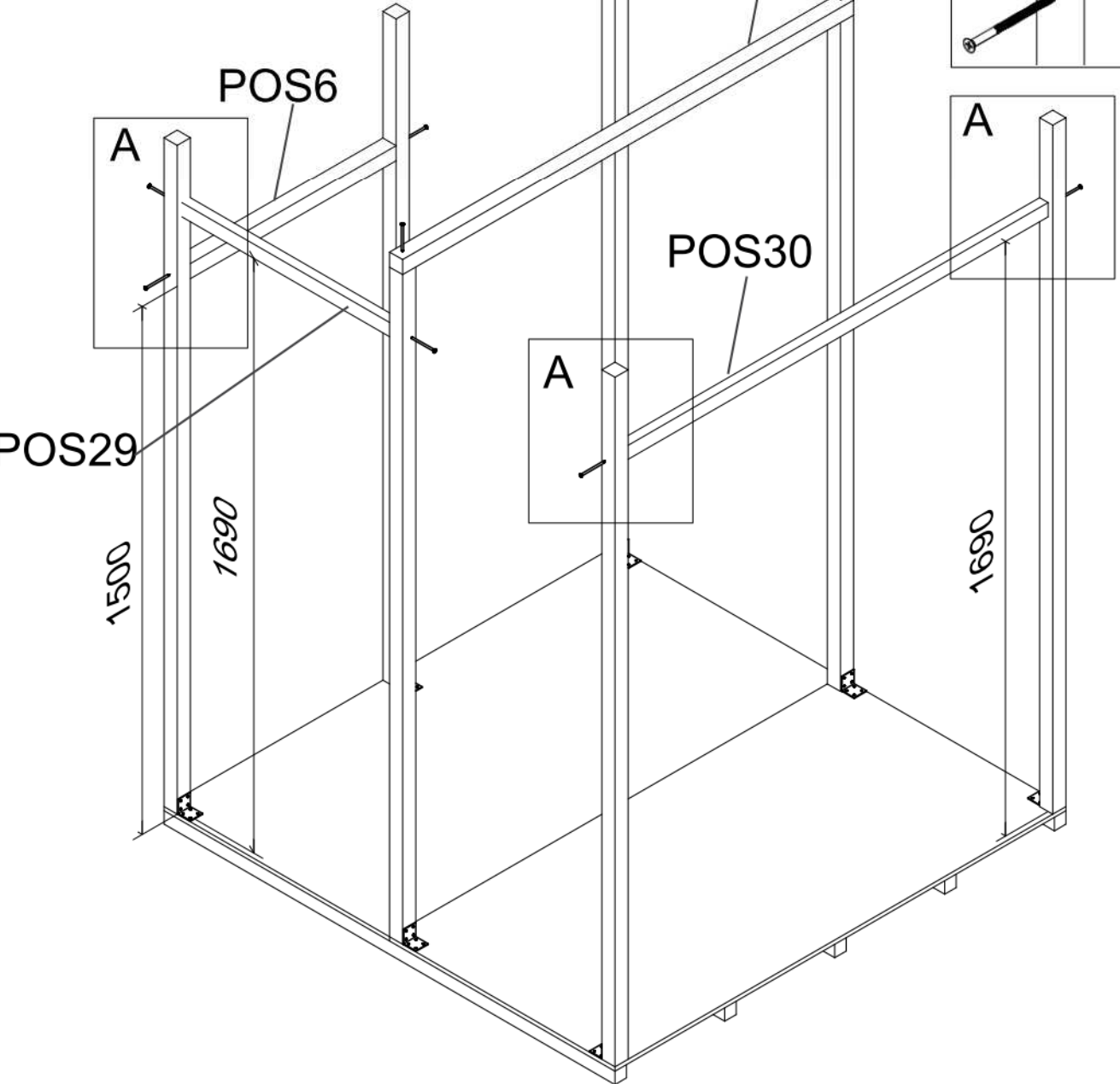
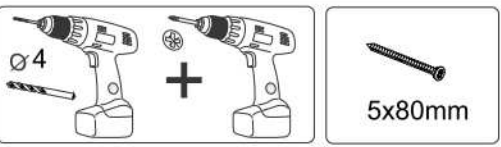
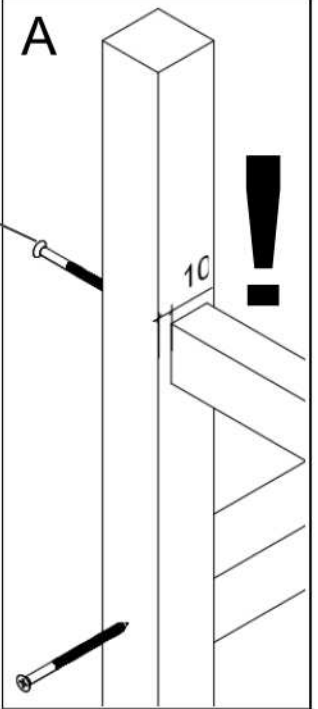

5

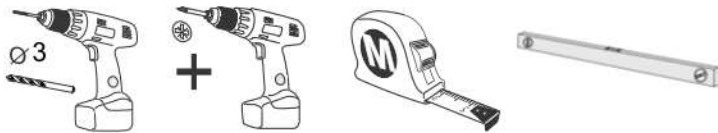

POS

7  18x98x740 1X

8  18x98x1480 2X

 16X
3,5x35mm

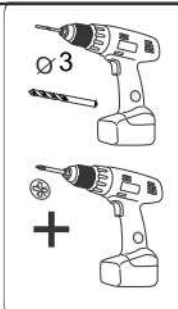

 3,5x35mm

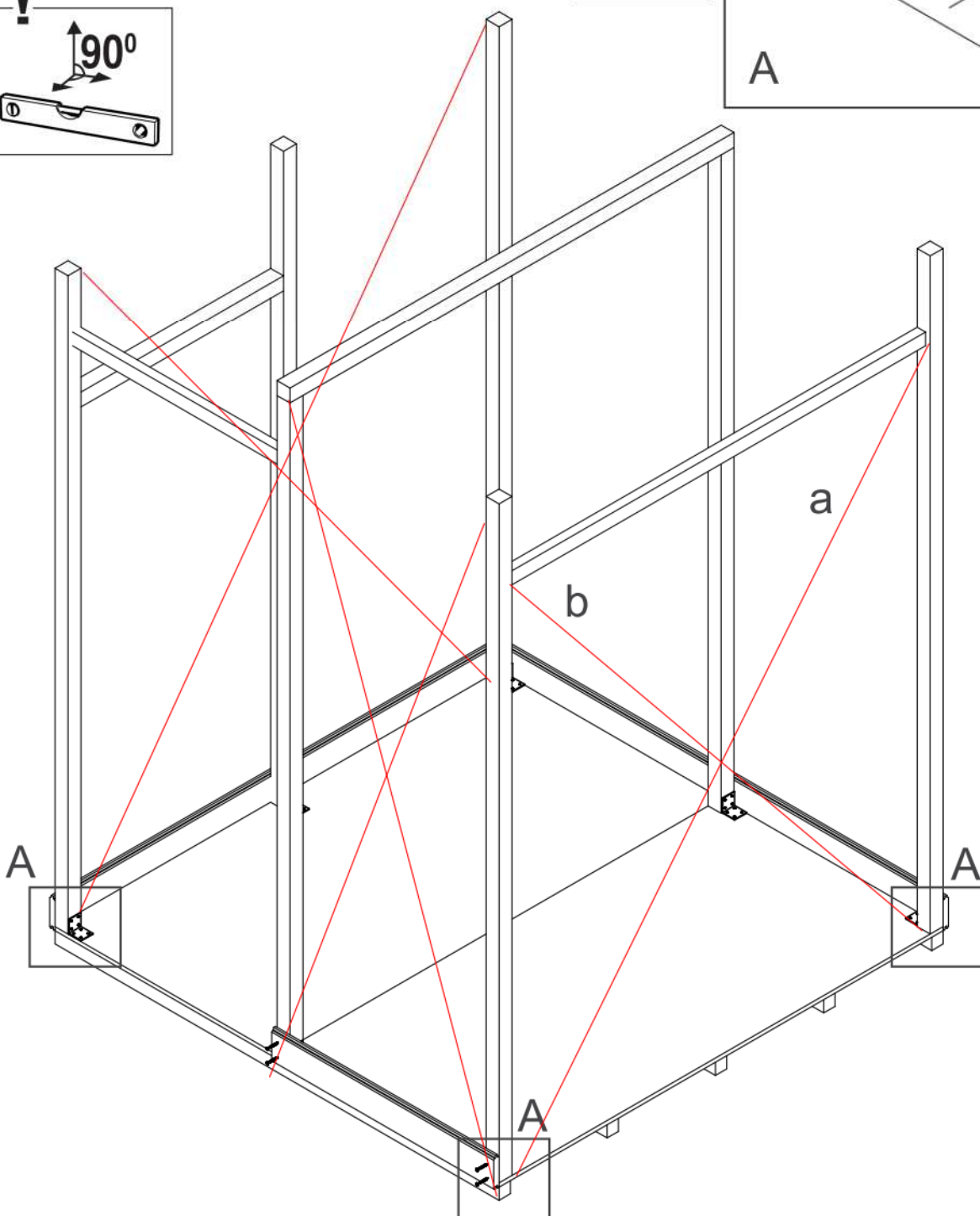
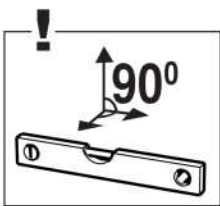
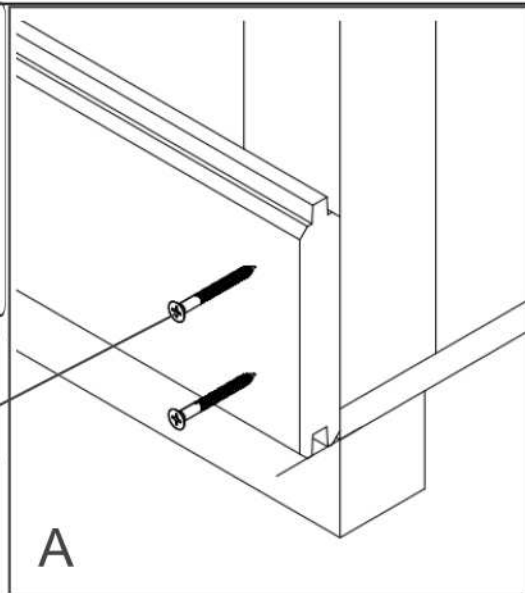

6

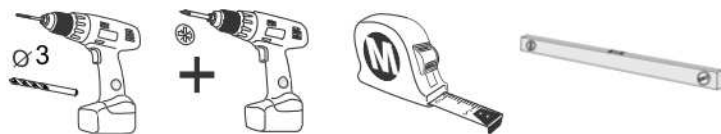

POS

15  27,6x40x750 2X

16  27,6x40x617 2X



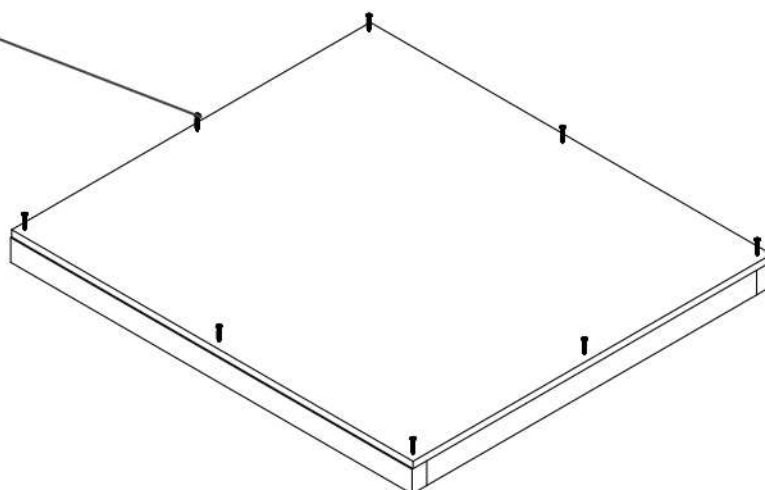
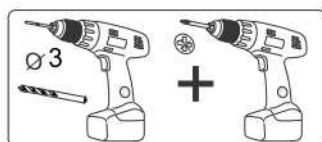
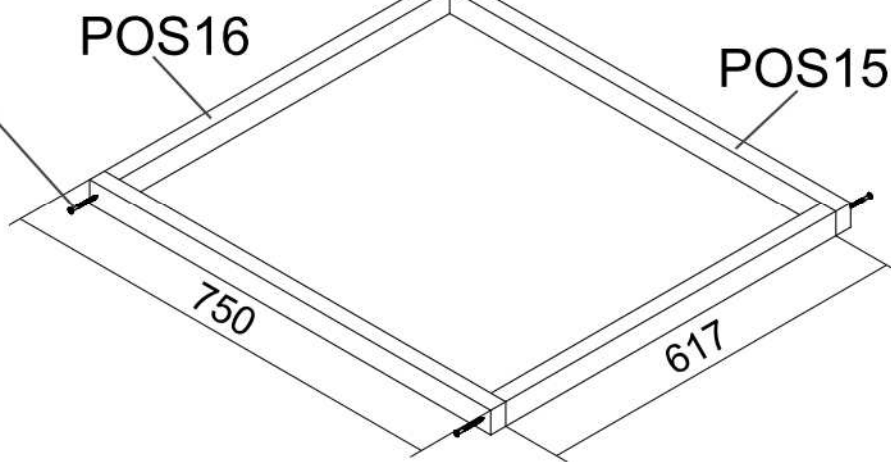
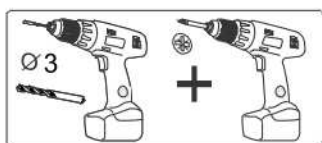
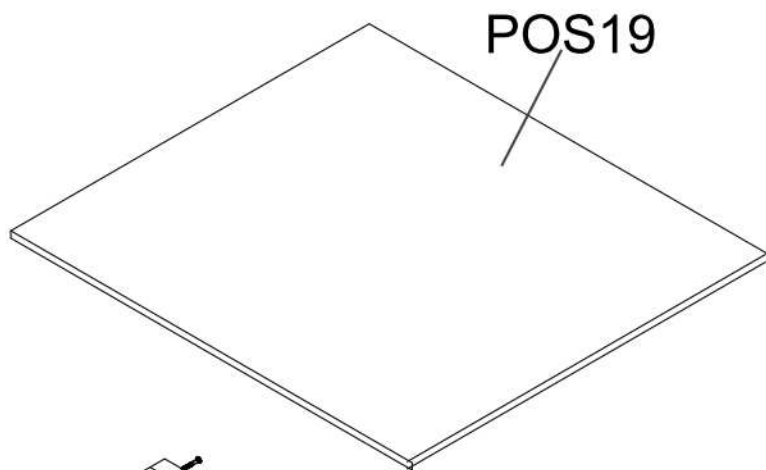
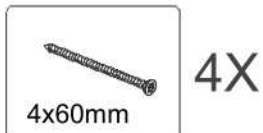

19  12x670x750 1X

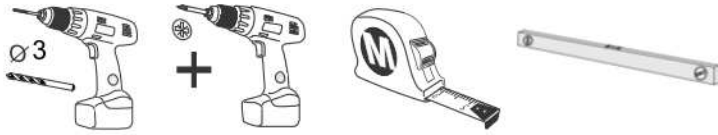

7



POS

- 14  27,6x40x700 4X
- 17  27,6x40x564 2X
- 18  27,6x40x1338 4X
- 20  12x620x1390 2X

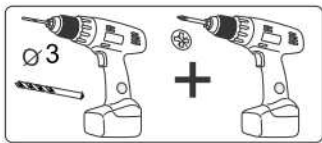
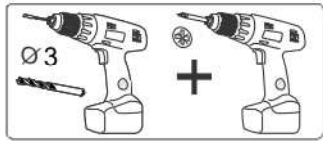
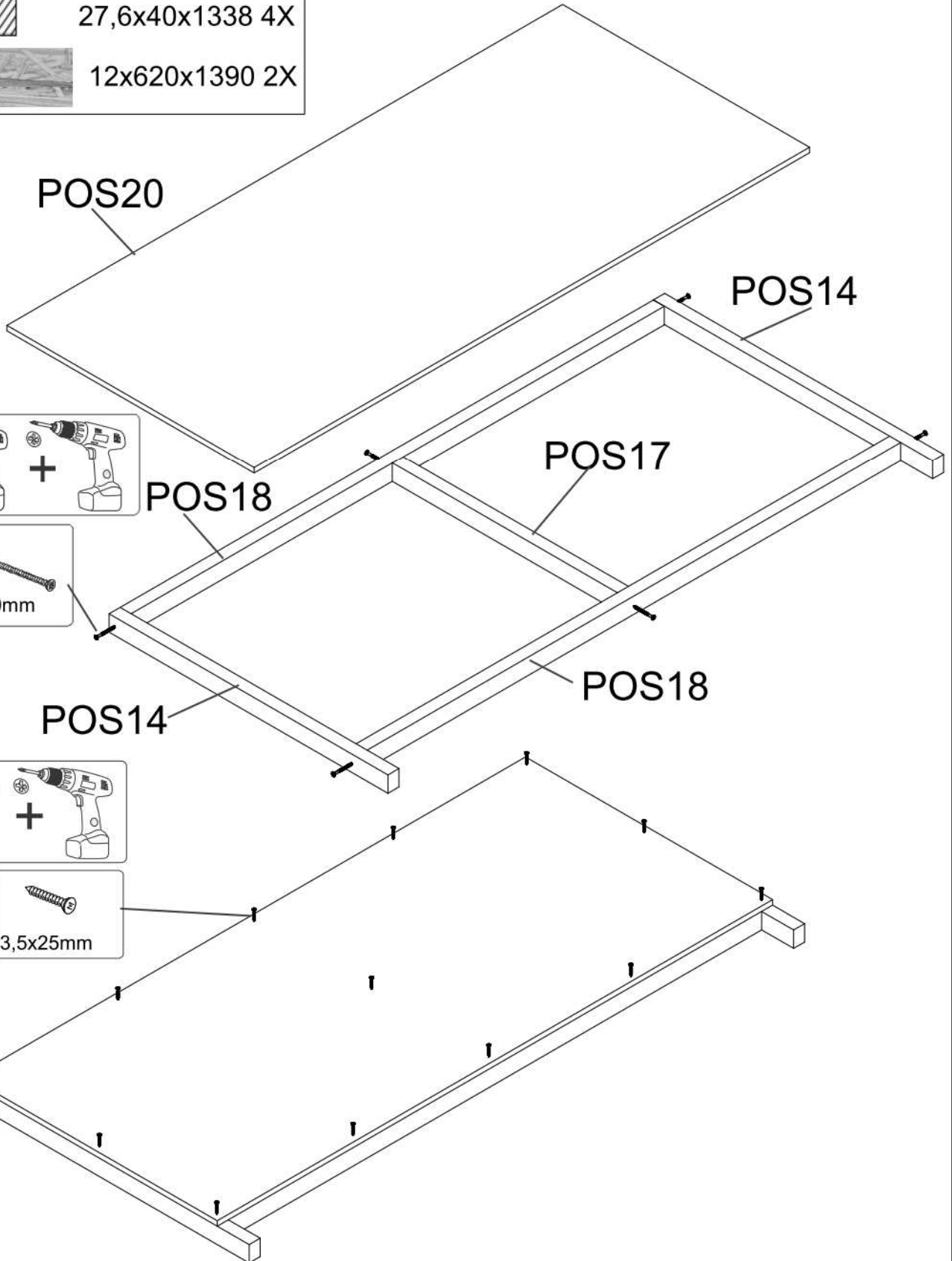
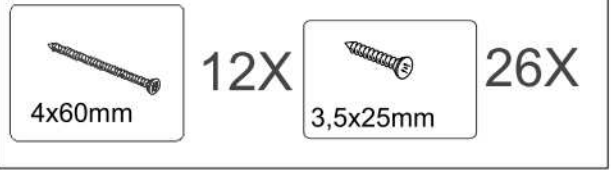

8

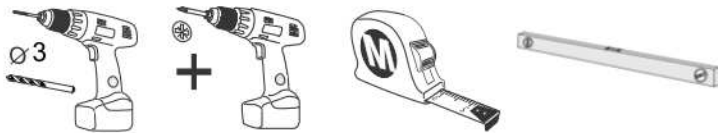

POS

7  18x98x740 8X

8  18x98x1480 16X

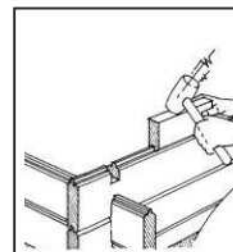
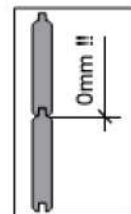
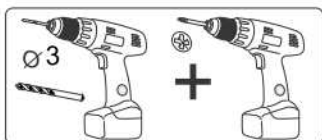
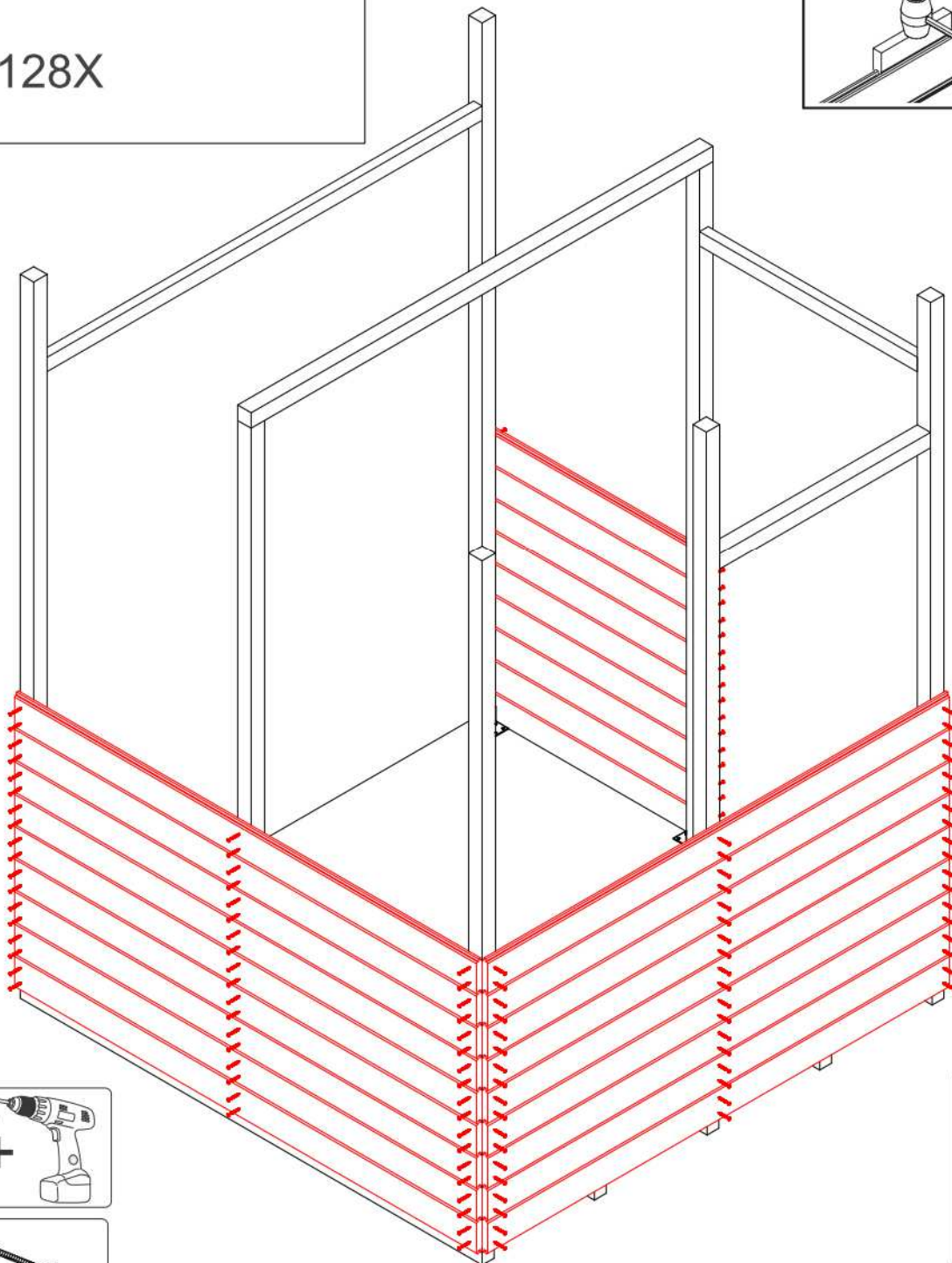
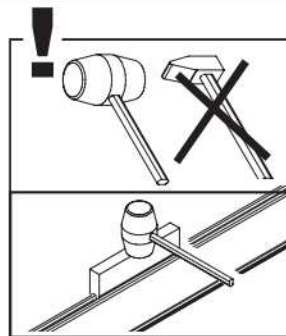

9

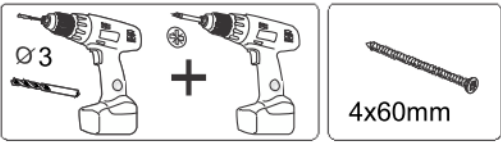
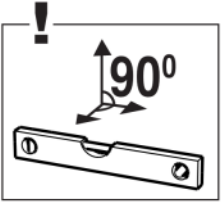
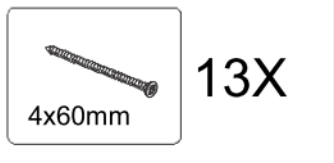
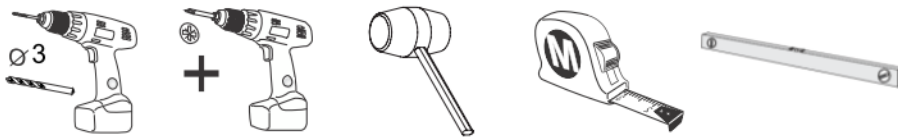

A

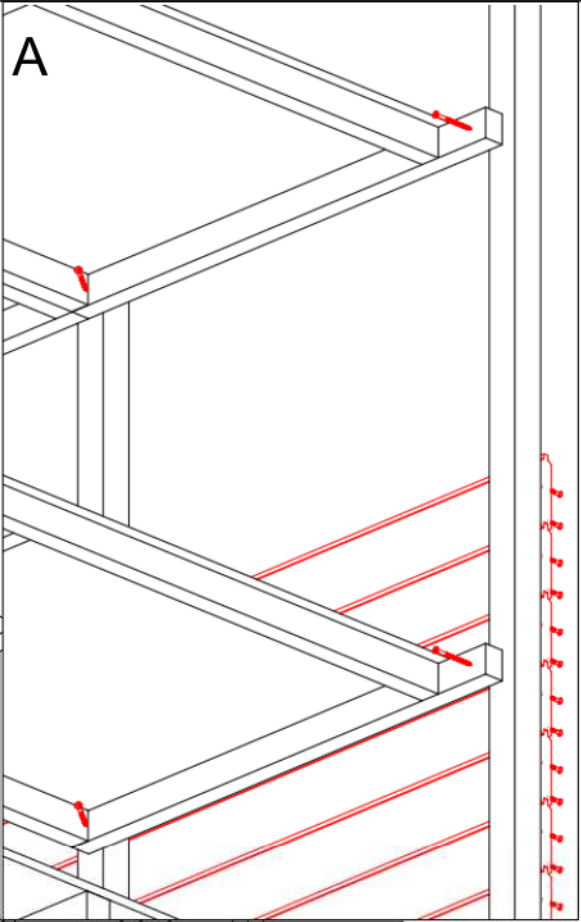

A

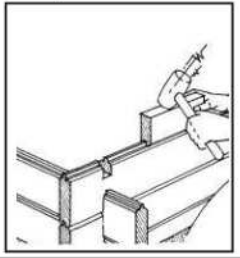
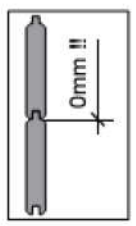
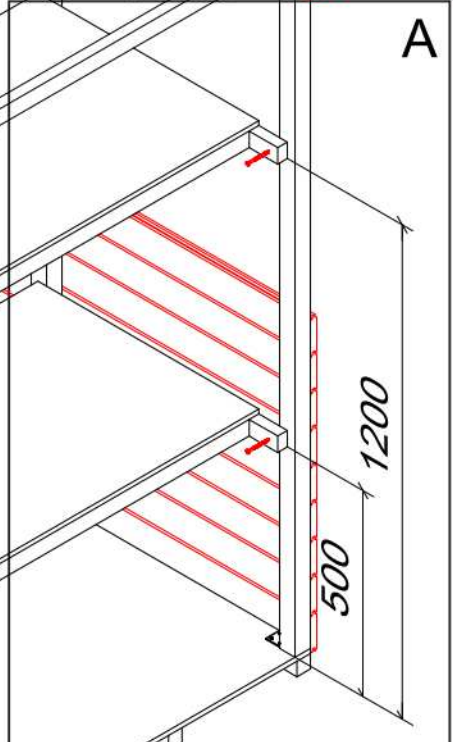

10

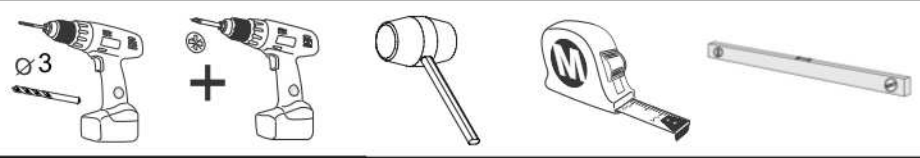

POS

7  18x98x740 10X

8  18x98x1480 20X

 160X
3,5x35mm

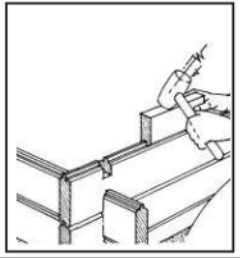
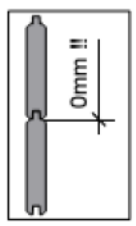
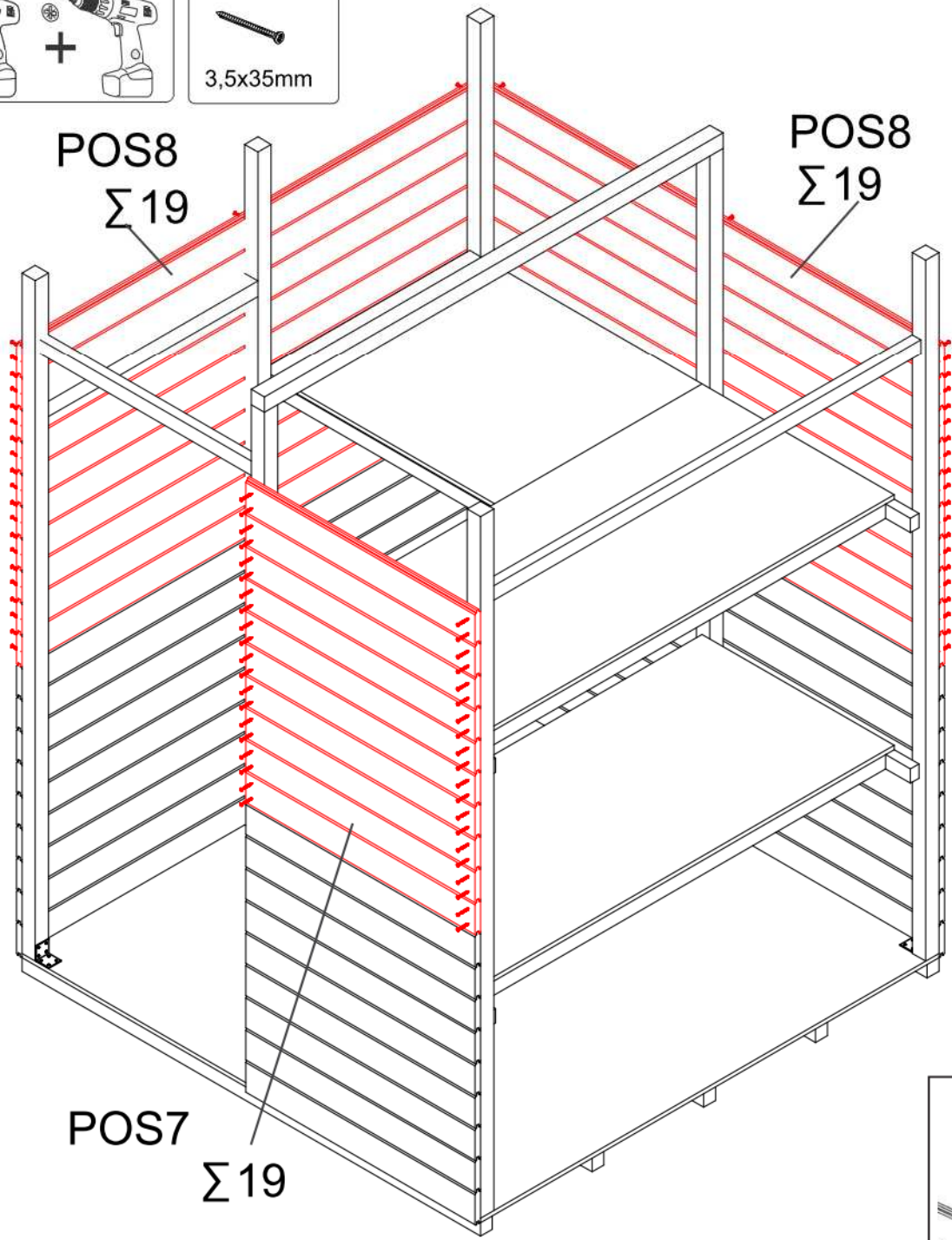
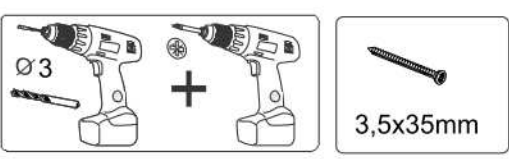
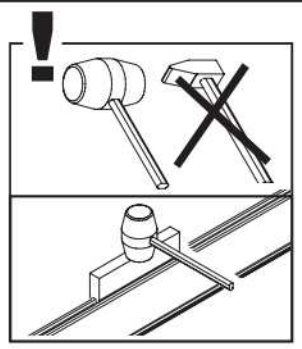

11

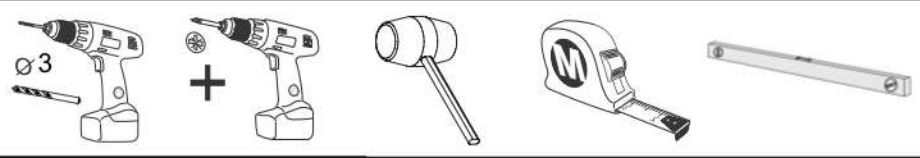

POS

11  18x98x1516 5X

8  18x98x1480 4X

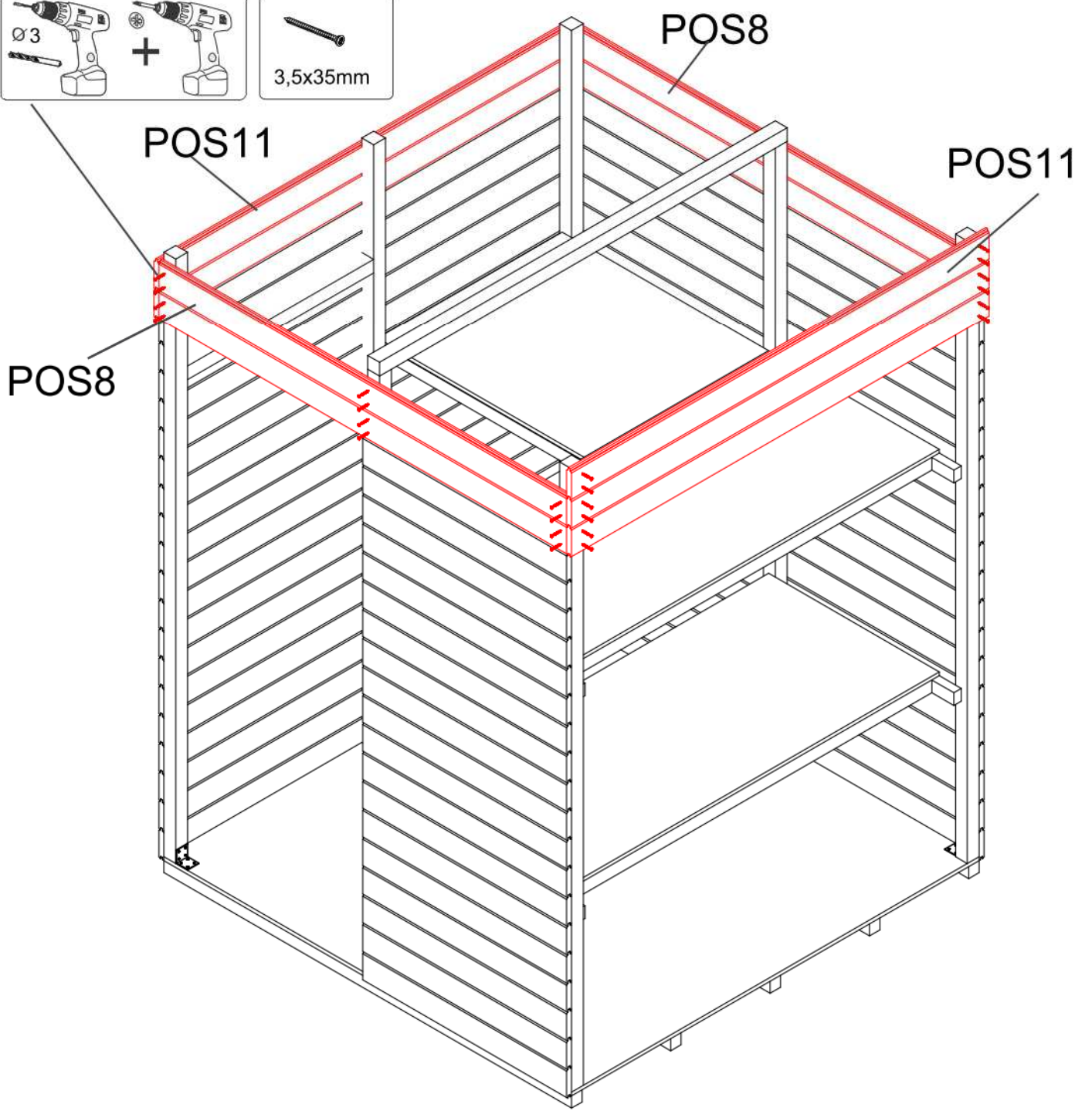
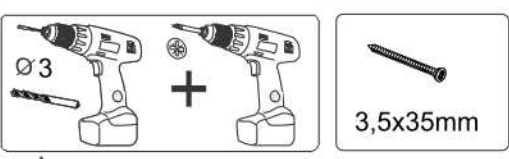
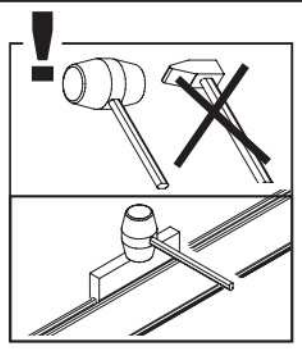
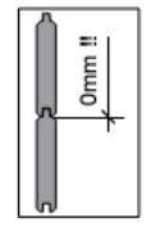

12

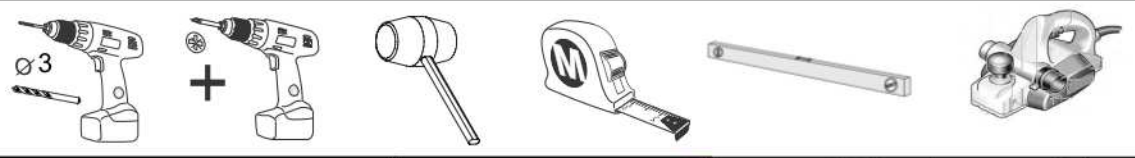

POS

9  18x98x1480 2X

10  18x45x1516 1X

 11X
3,5x35mm

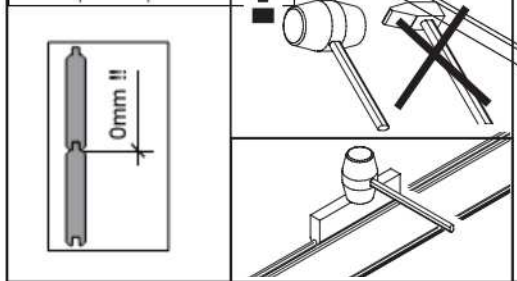
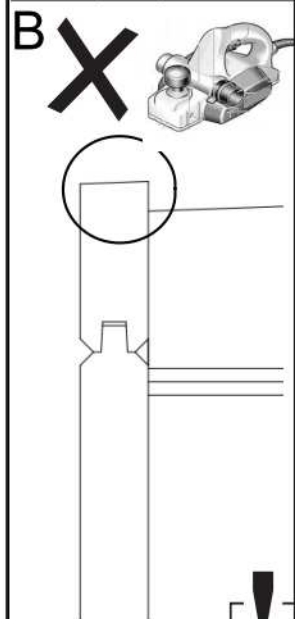
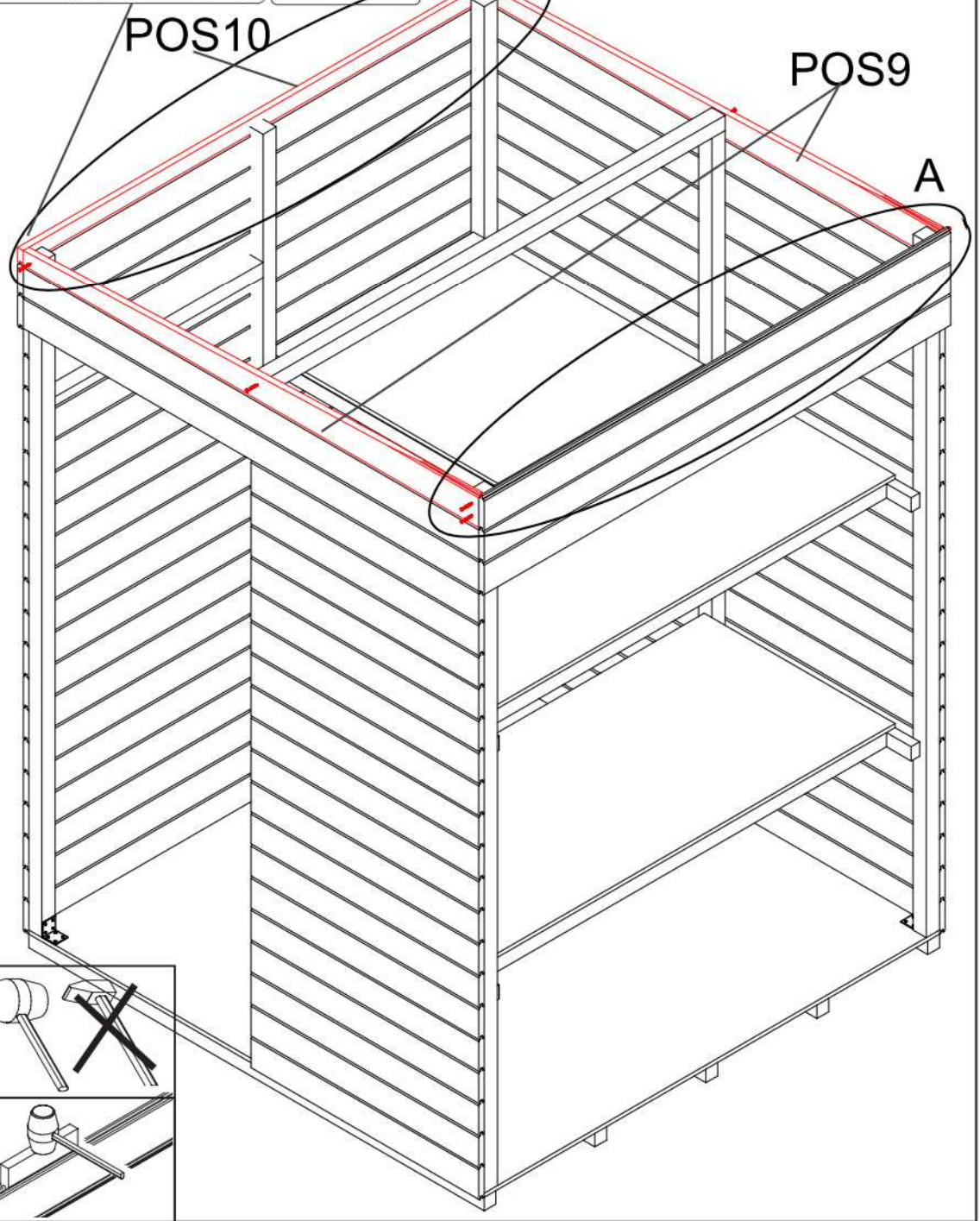
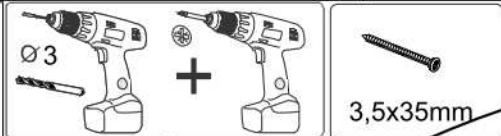
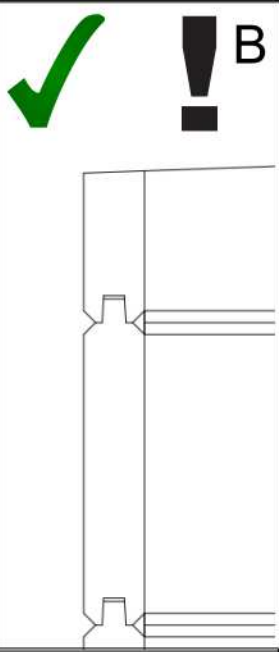
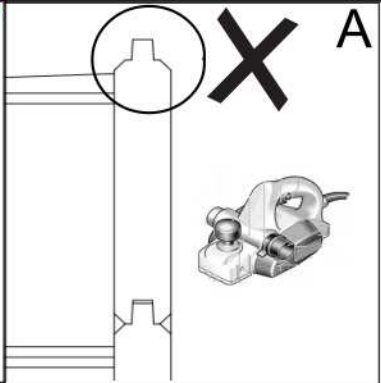
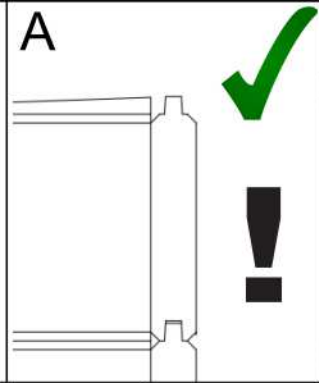

13



POS

21  12x610x1770 2X

22  12x400x1770 1X

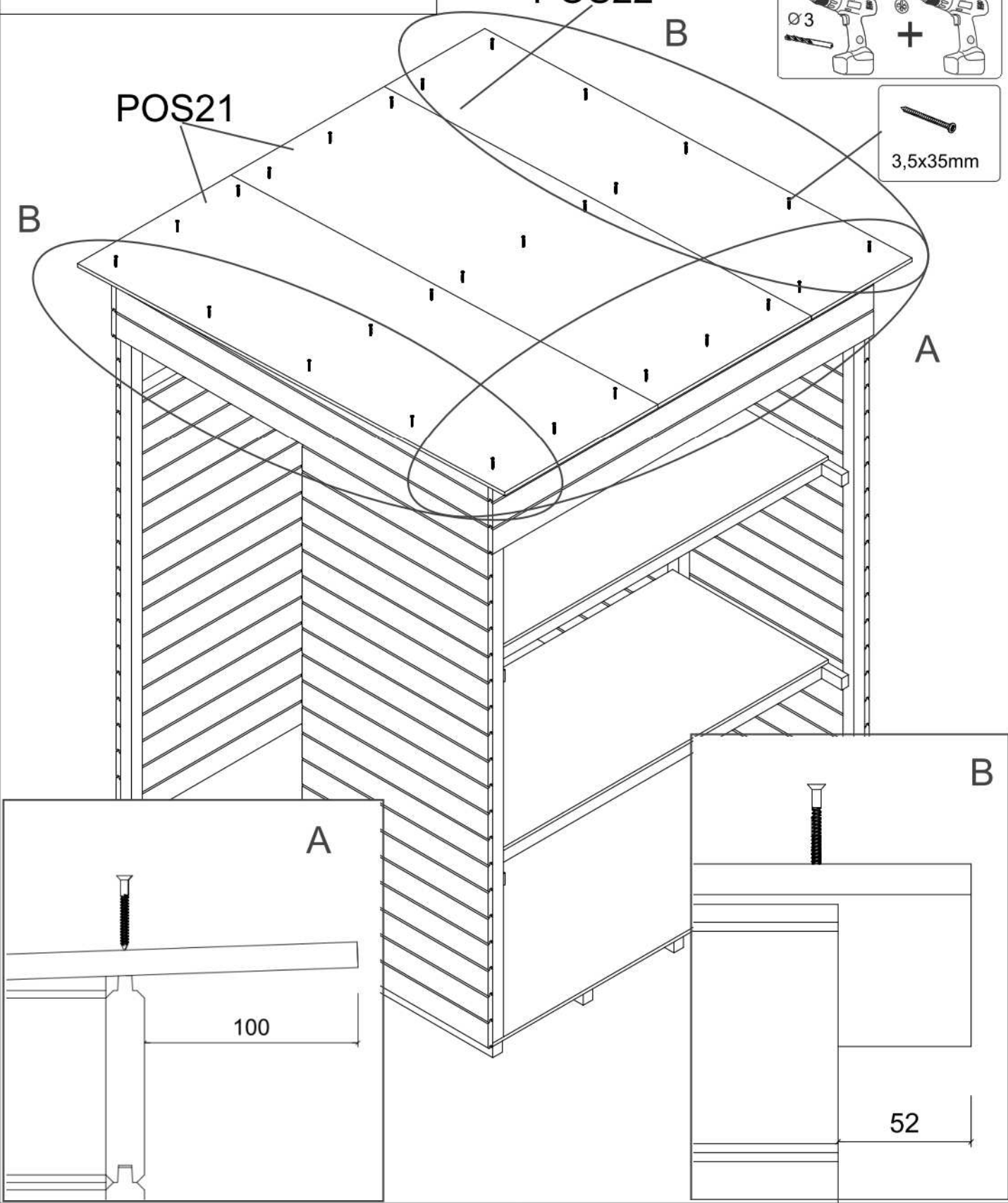
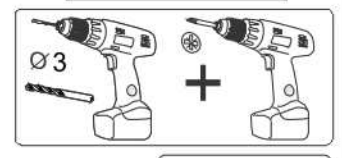
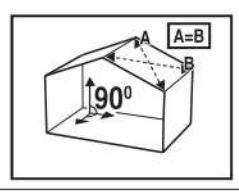

14

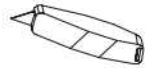

POS

27



12x26x1600 1X

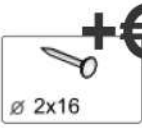

22X



4X

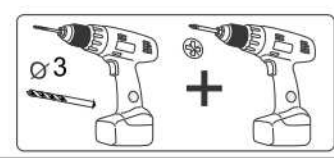
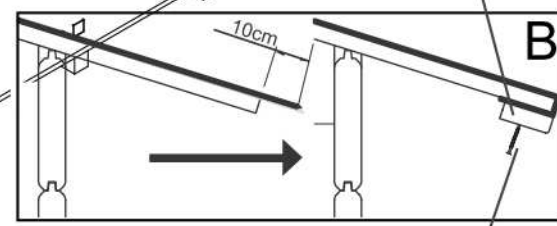
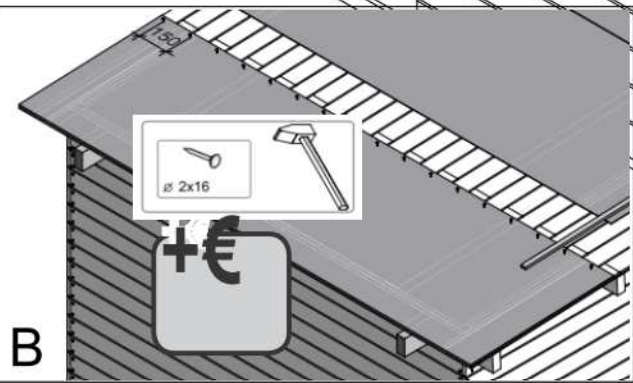
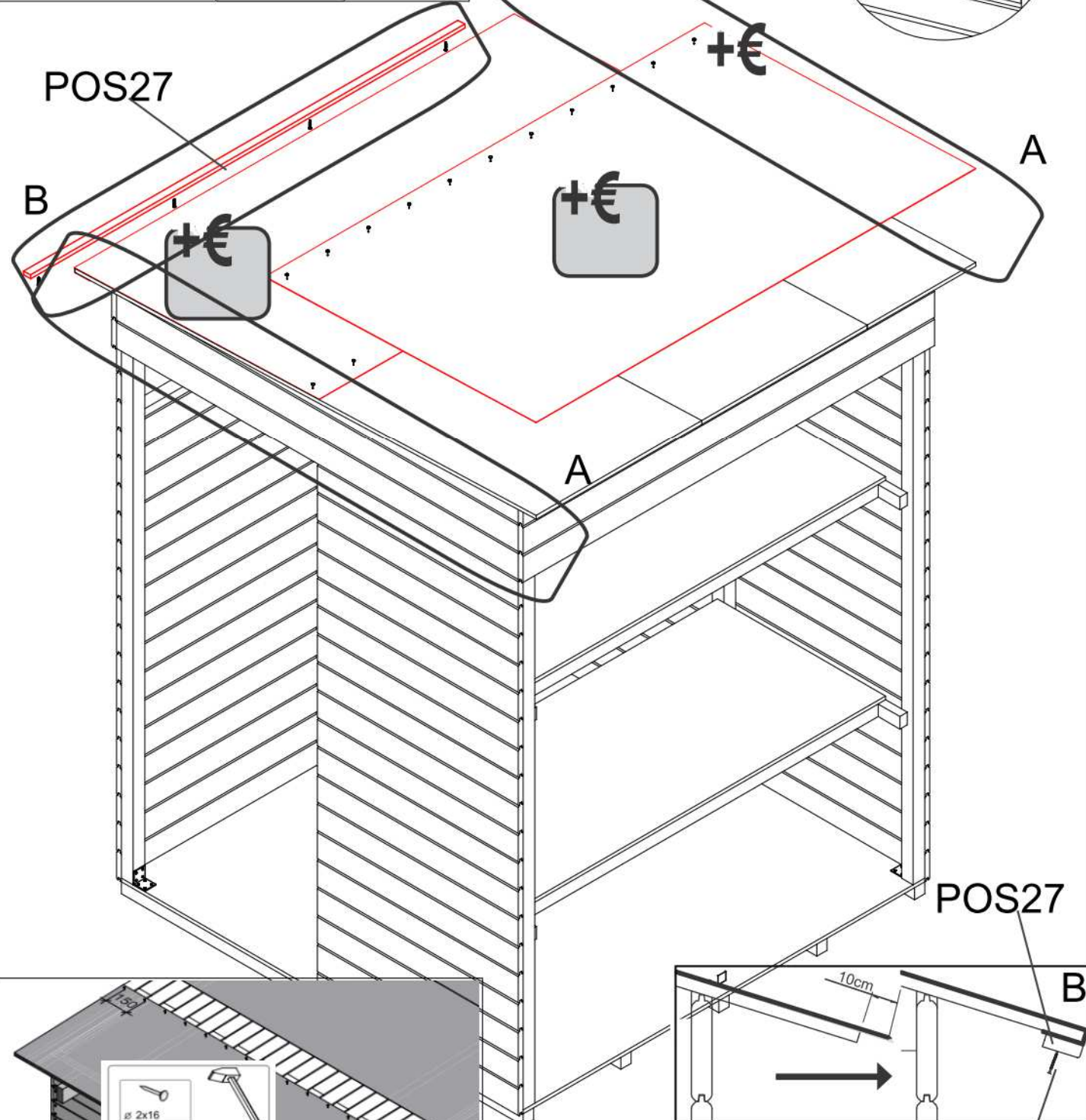
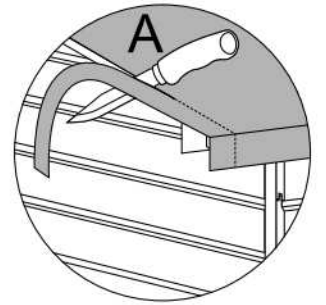

15



POS

28



20,6x27,6x1186 3X



9X

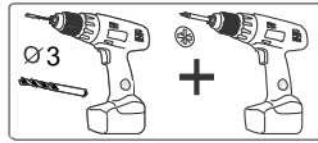

POS28

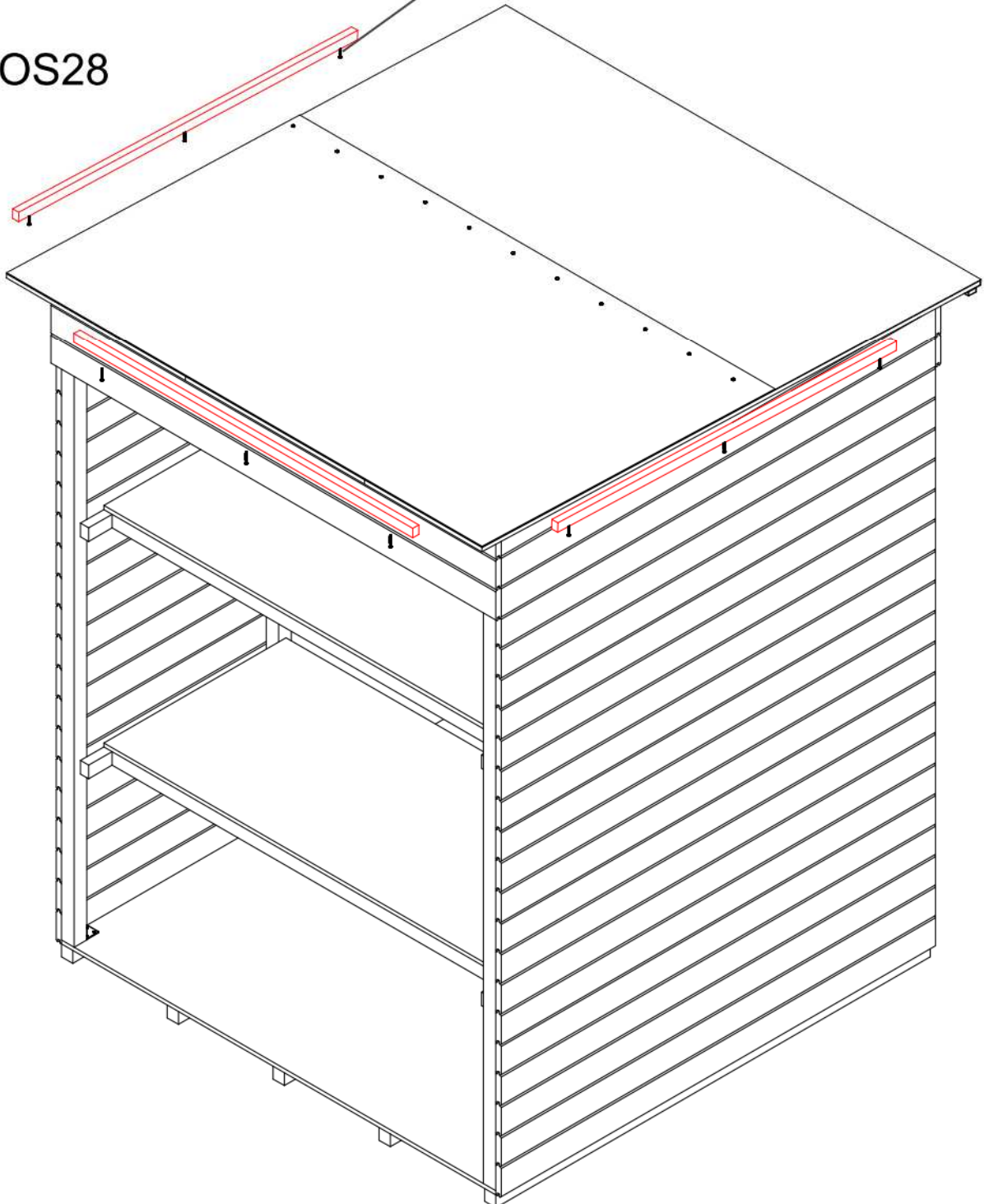

16

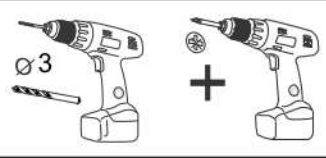

POS

26



12x26x1740 2X

23  **15x95x1650 1X**

24  **15x95x1740 2X**

25  **12x26x1650 1X**

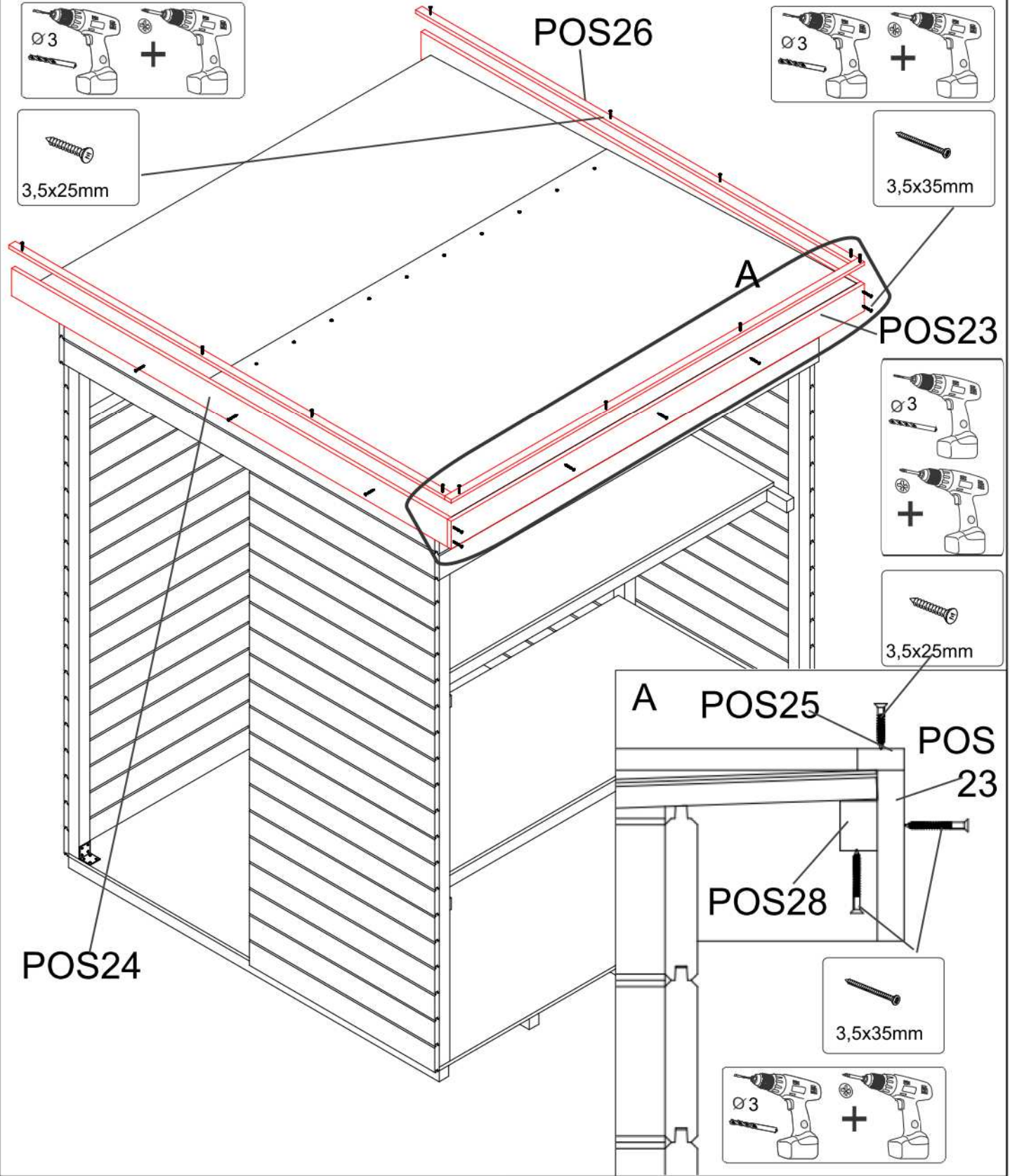
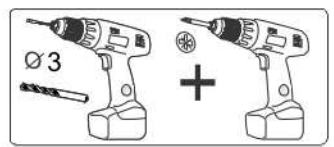
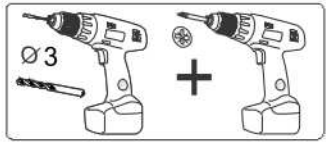
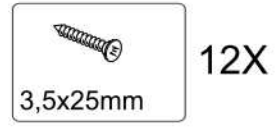

17

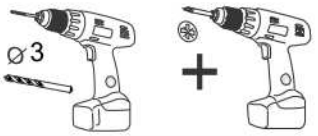

POS

12



18x61x1710 3X



9X

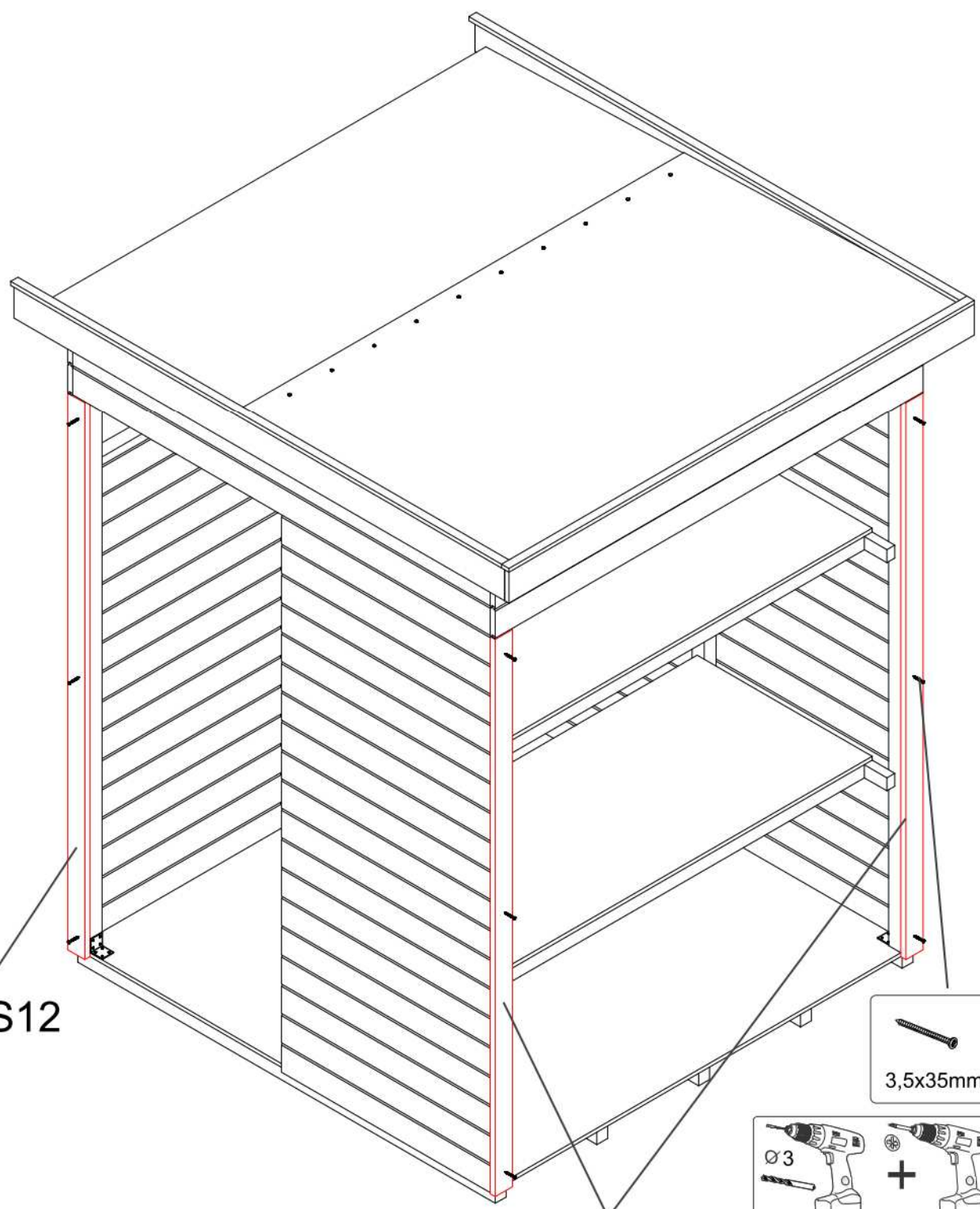

POS12

POS12

18

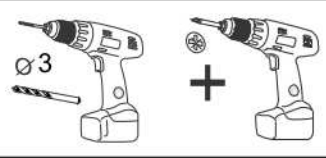

POS

31  Lap.688x1699_NP_Z 2X



18X

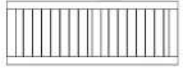

24X

32  Lap.688x1699_NP_Ü 1X

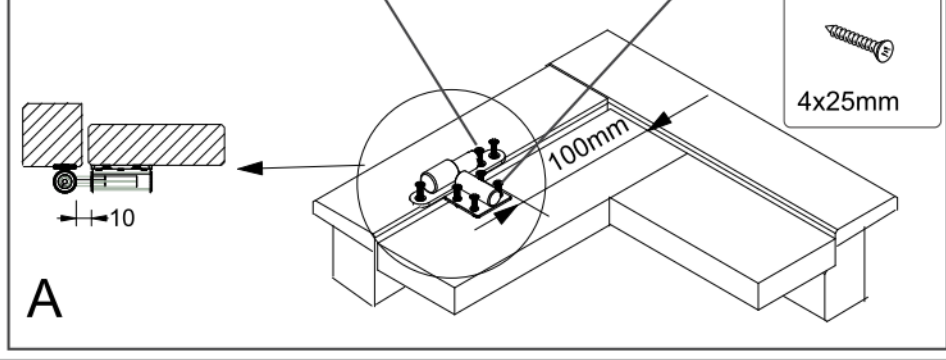
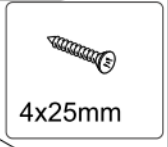
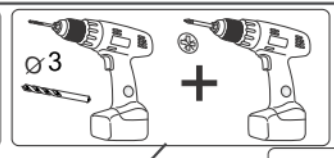
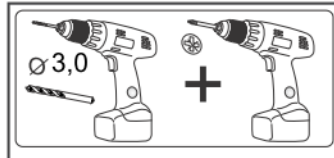
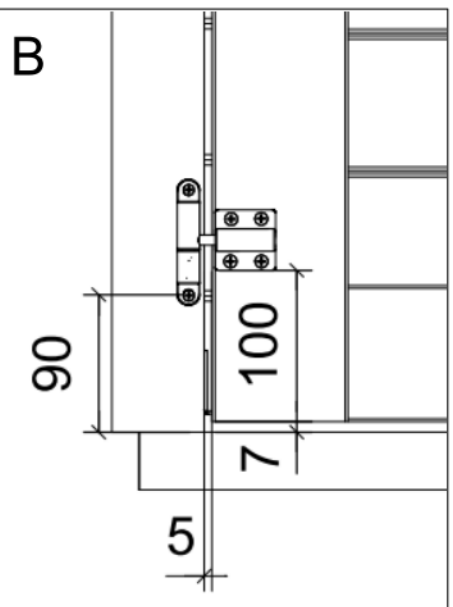
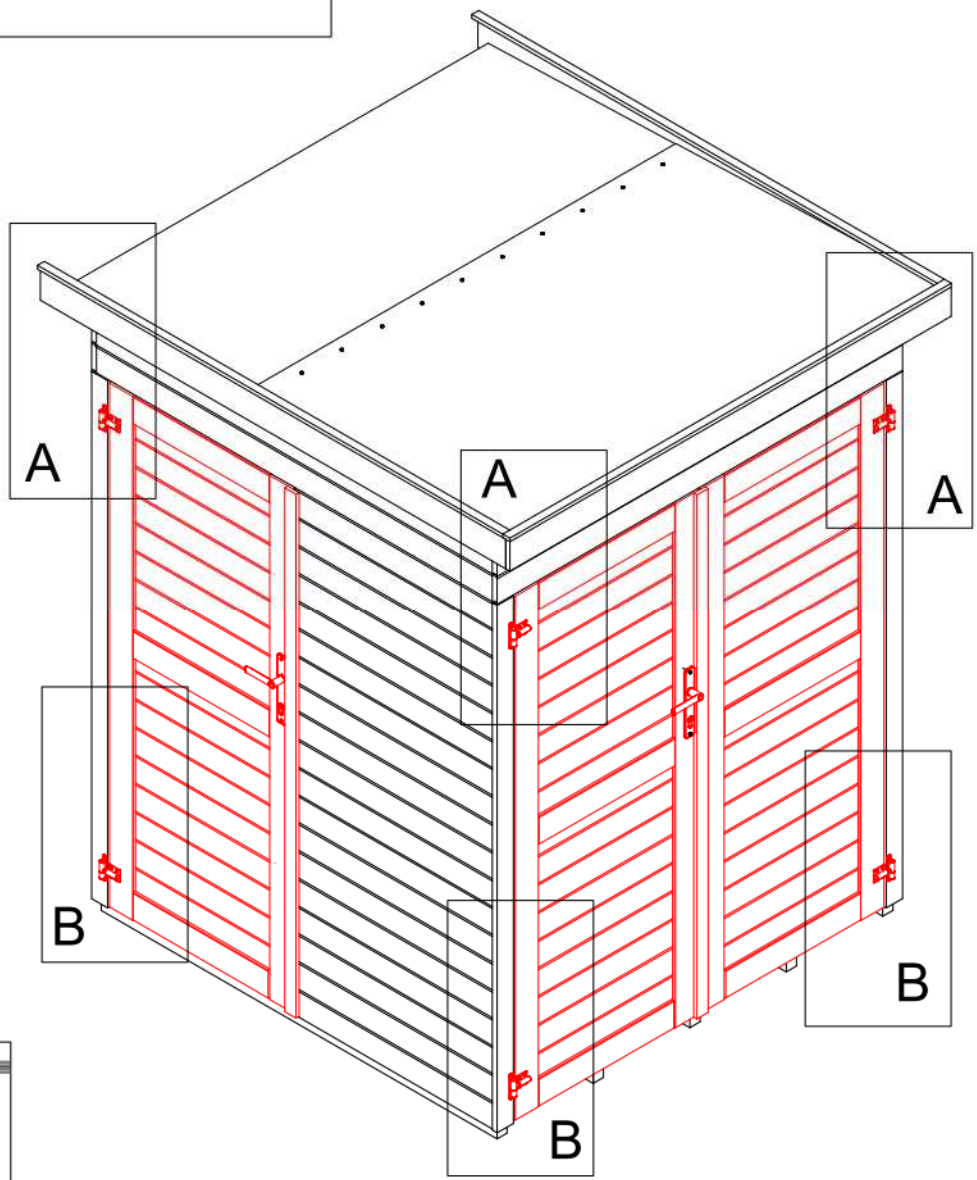
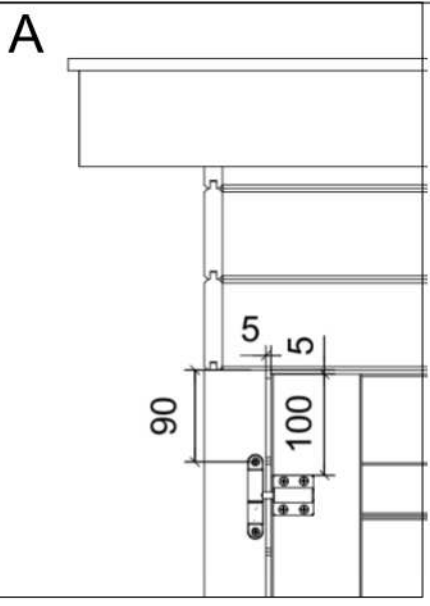

19



- 3,5x25mm 18X
- 2X
- 2X
- 2X

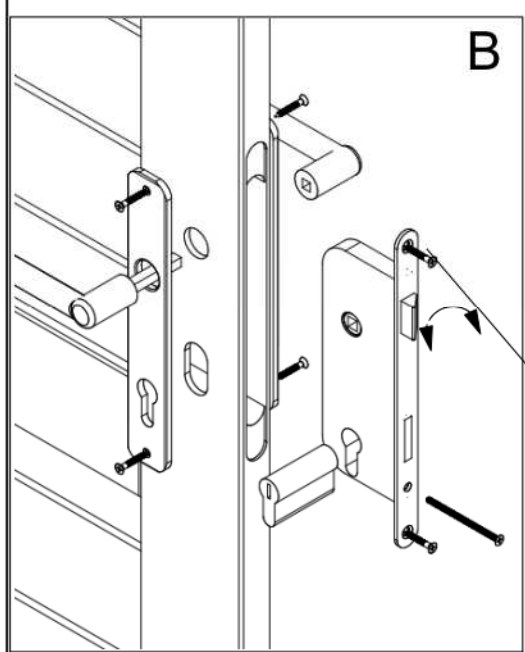
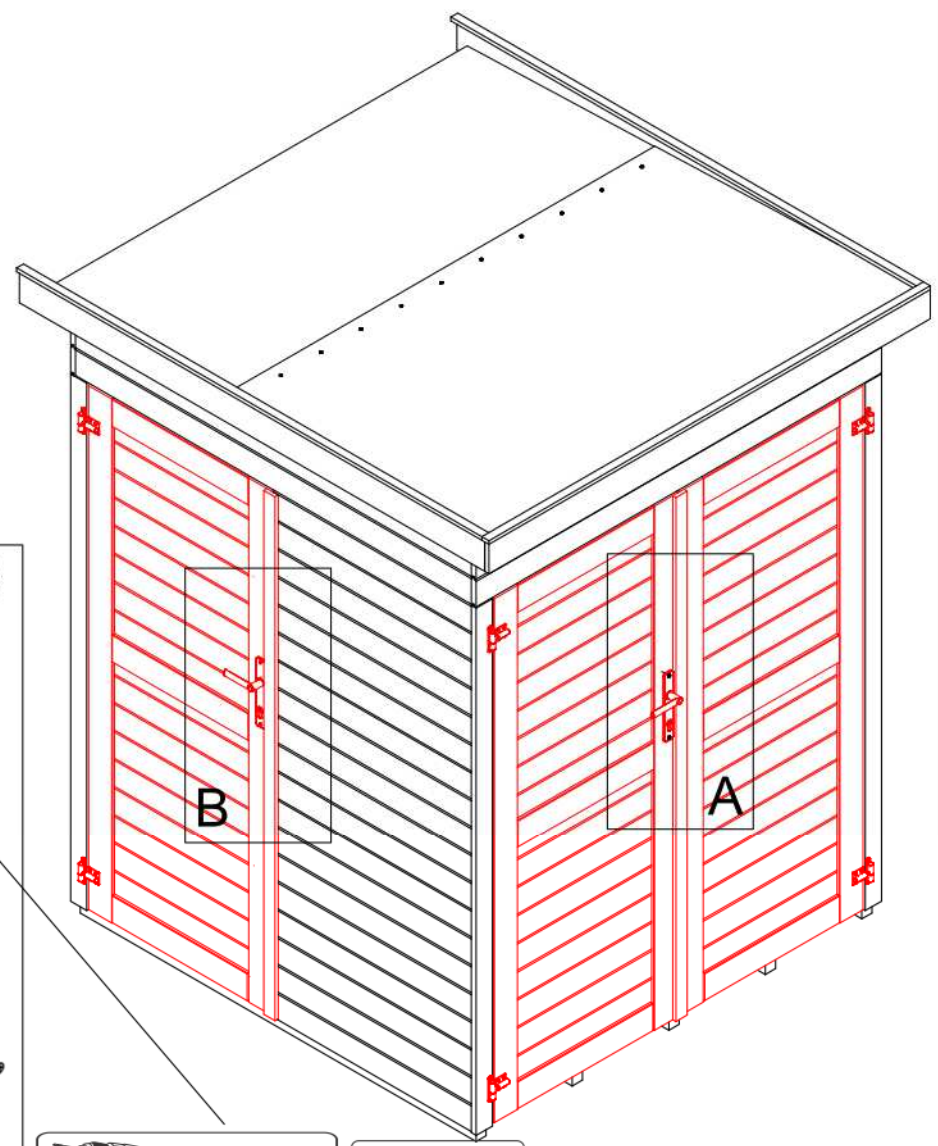

- 3,5x25mm

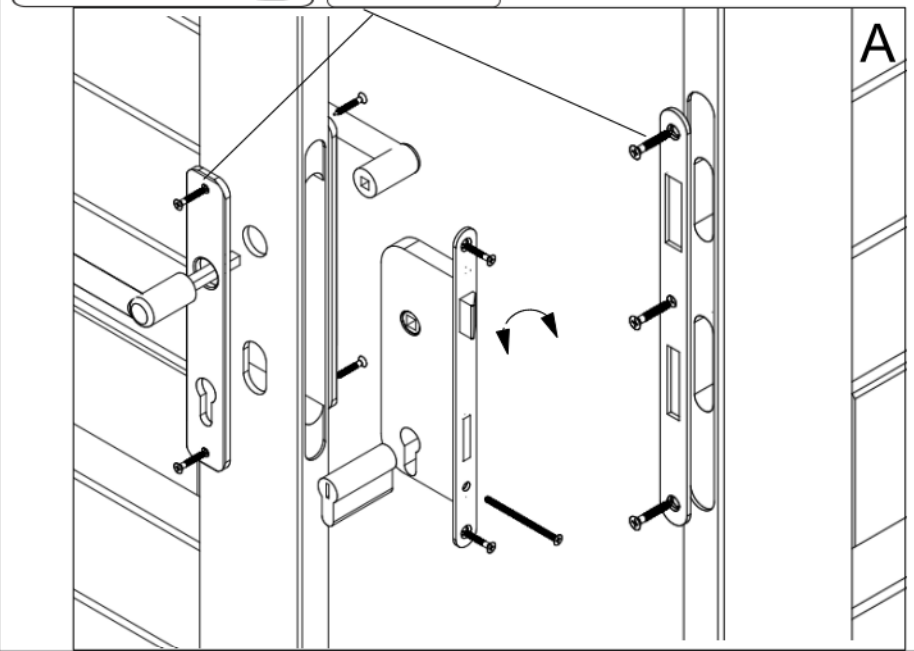
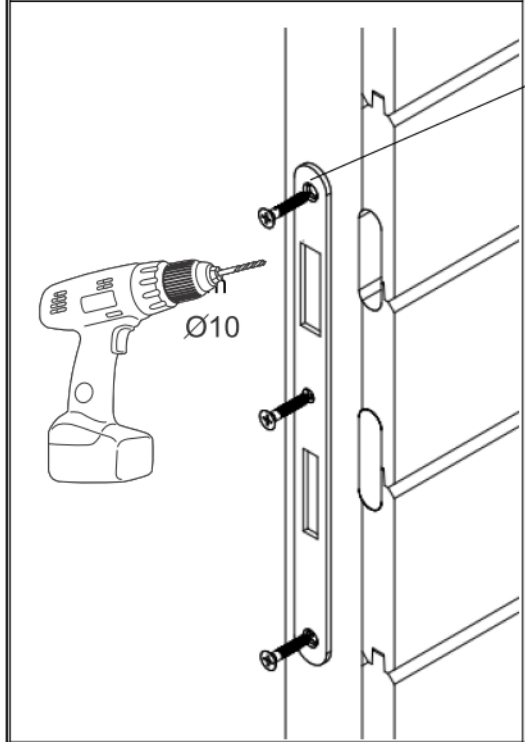

20



8X
3,5x25mm

2X

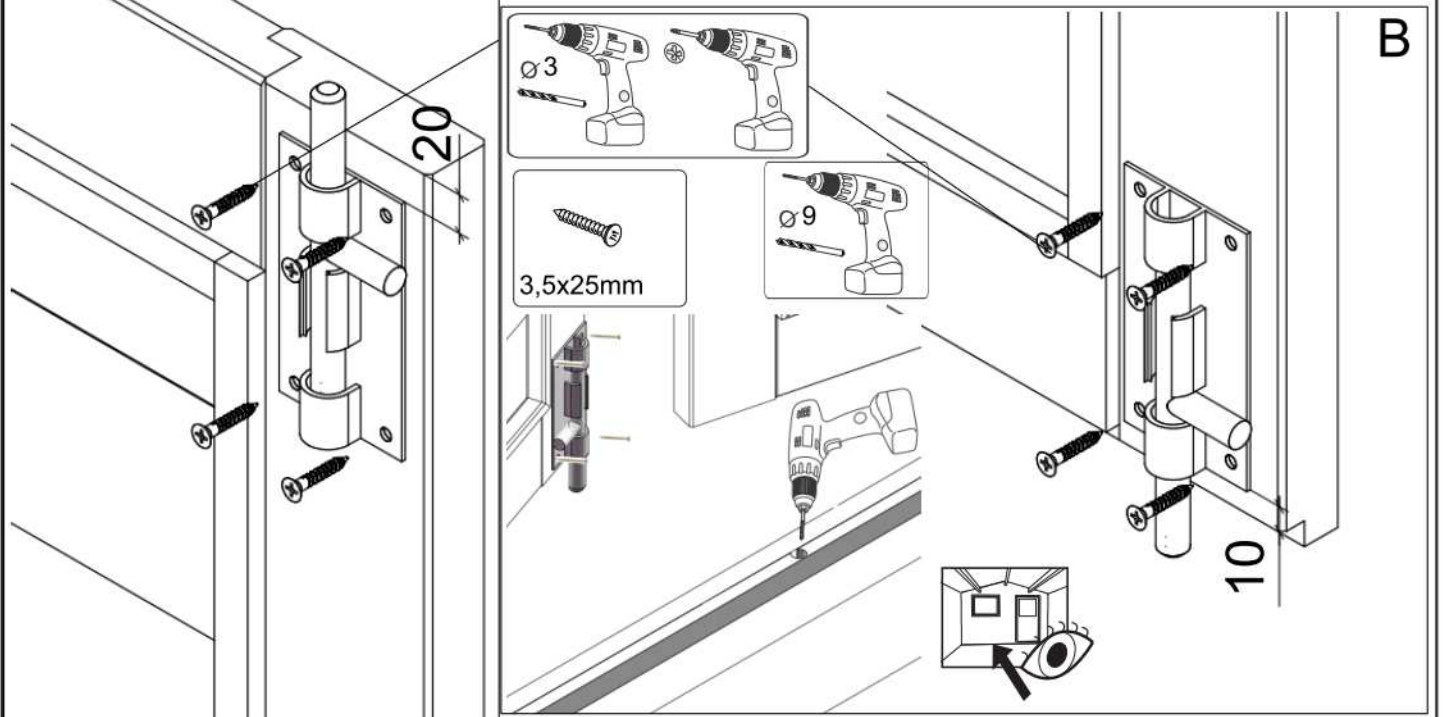
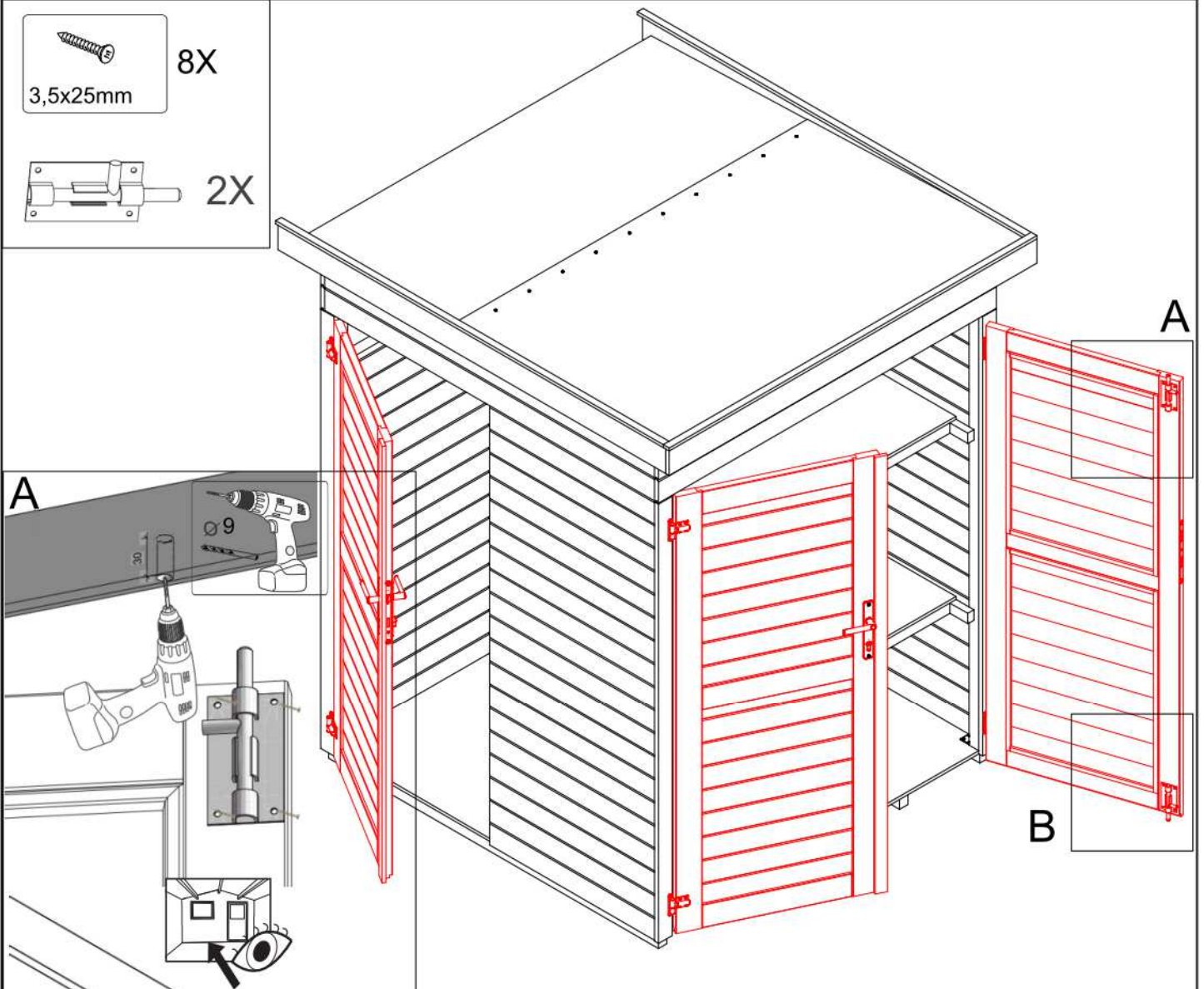

21



POS

33  12x42x1699 2X

 8X
3,5x25mm

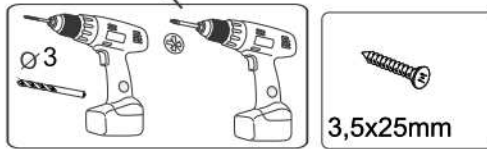
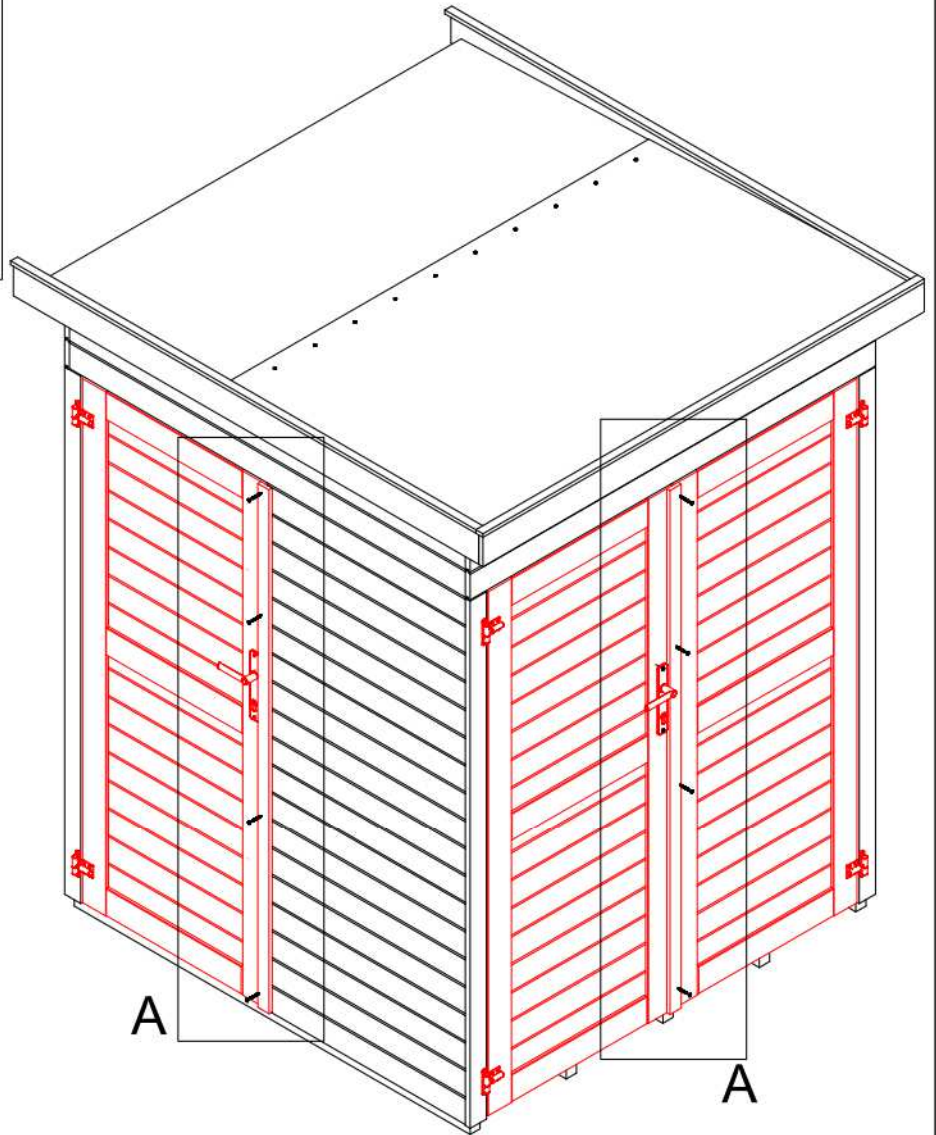
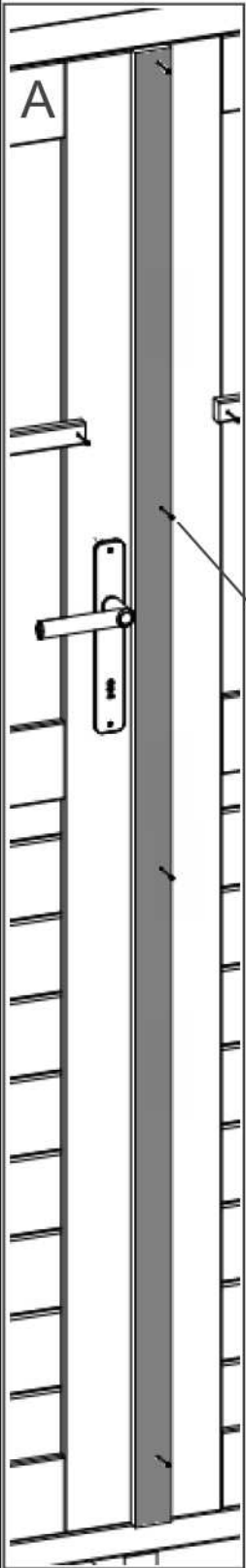

22

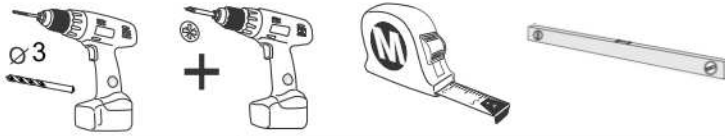

POS

13  12x42x1950 6X



24X

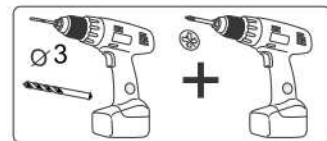
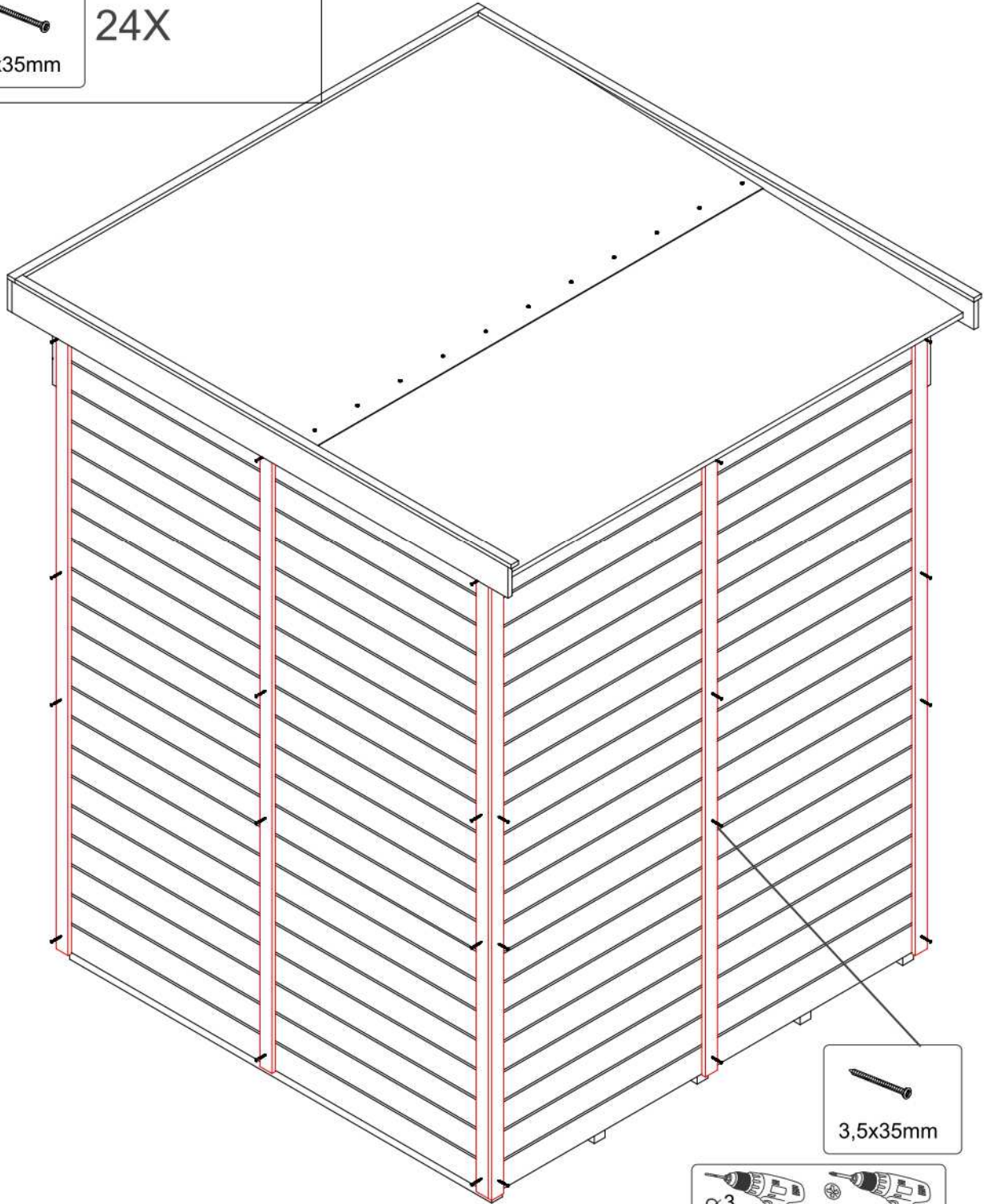

23



POS

13  12x42x1950 2X



12X

3,5x35mm

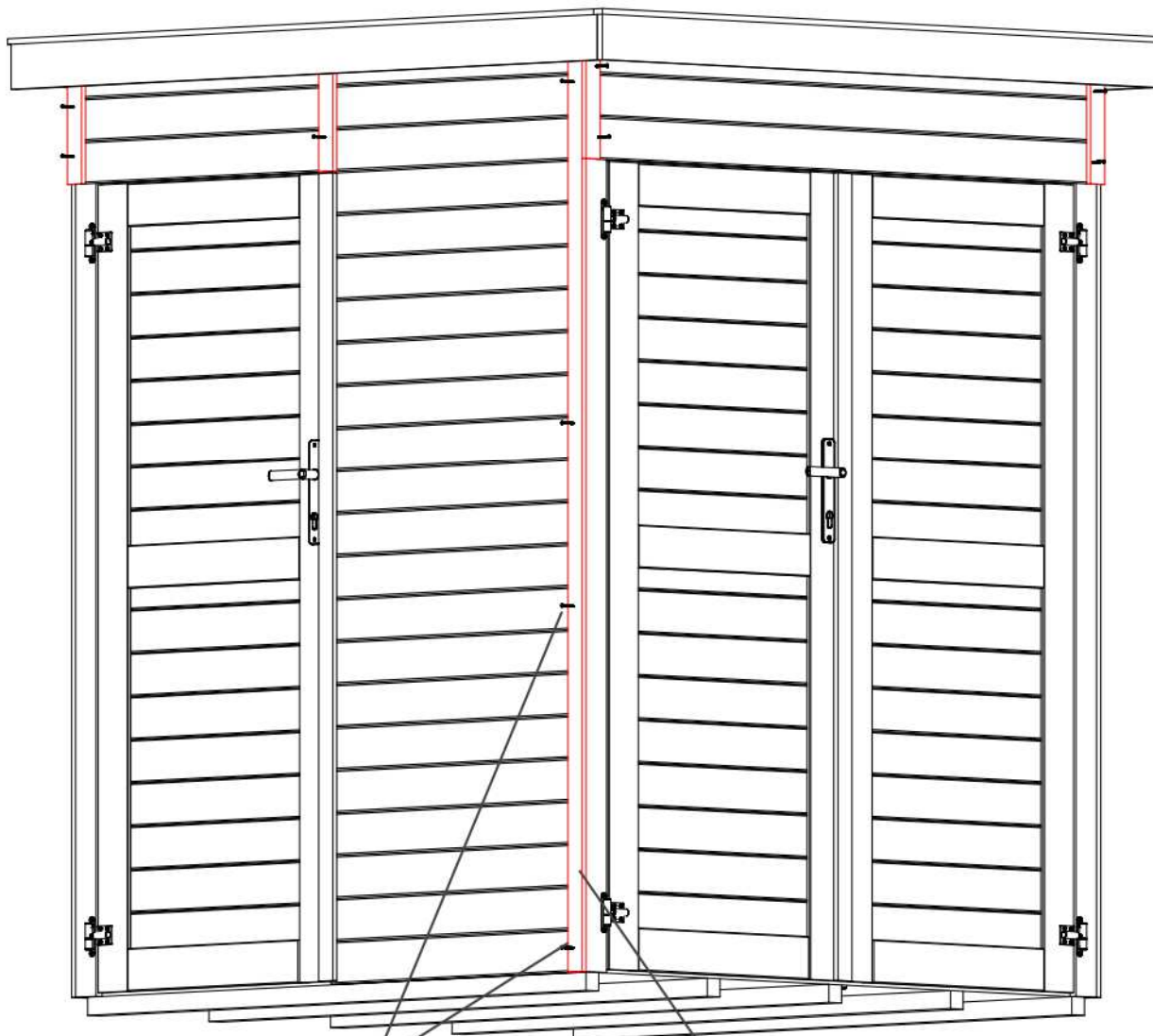

POS13

