

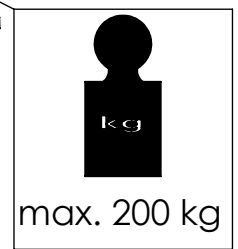

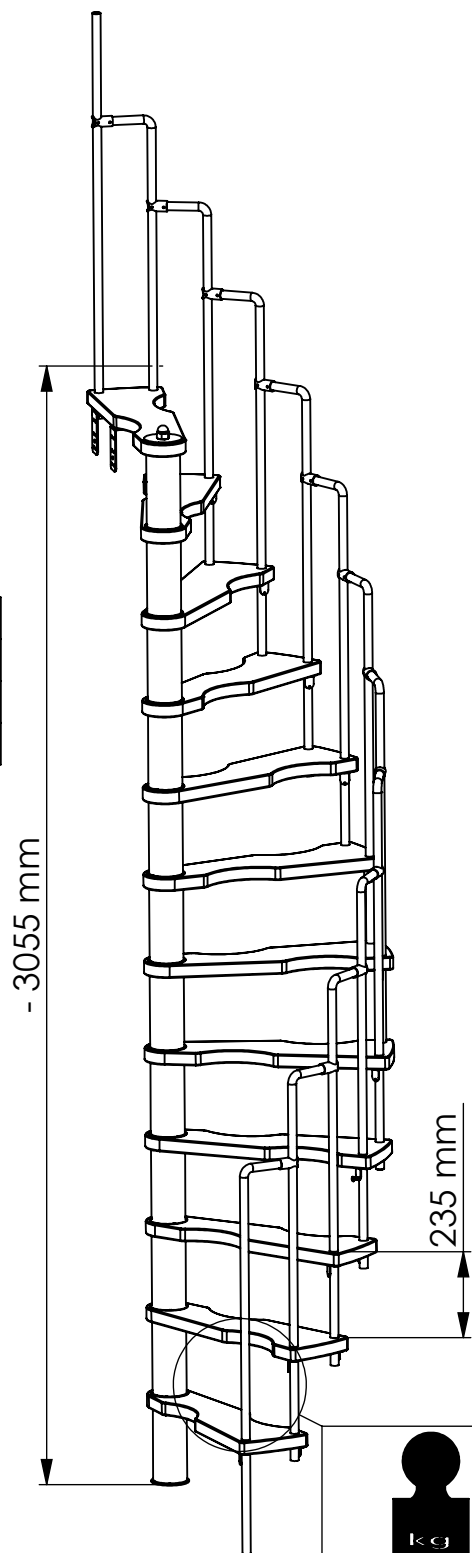

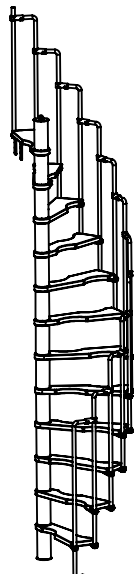

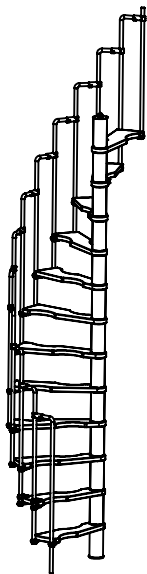

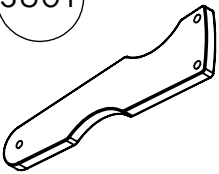
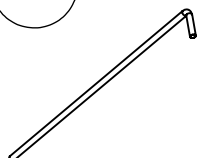
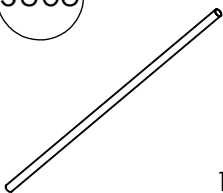
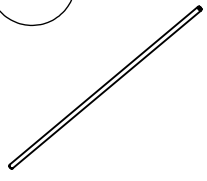
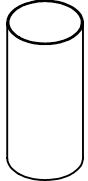
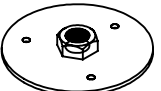

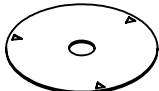
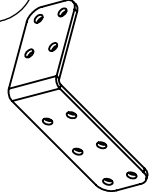
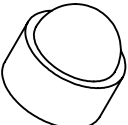
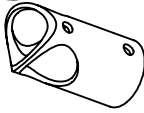

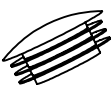
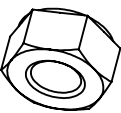
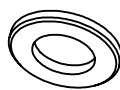
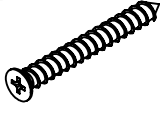
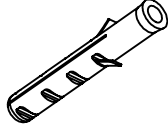
	5	4	3	2	1
H	2115	2350	2585	2820	3055
A	112°	126°	140°	154°	168°
B	96°	108°	120°	132°	144°

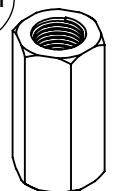
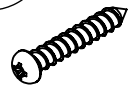

<p>SU01</p>  <p>12x</p>	<p>SU02</p>  <p>12x</p> <p>Ø22x1x1045+140mm</p>	<p>SU03</p>  <p>1x</p> <p>Ø22x1x1030 mm</p>	<p>SU04</p>  <p>3x</p> <p>M16x1000 mm</p>	<p>SU05</p>  <p>12x</p> <p>Ø90x198 mm</p>
<p>SU06</p>  <p>1x</p> <p>Ø100x3mm M16</p>	<p>SU07</p>  <p>1x</p> <p>Ø100x3mm</p>	<p>SU08</p>  <p>25x</p> <p>Ø100x1,5mm</p>	<p>SU09</p>  <p>2x</p>	<p>SU11</p>  <p>1x</p> <p>M16</p>
<p>SU12b</p>  <p>12x</p> <p>Ø28x2x50 mm</p>	<p>SU13b</p>  <p>24x</p>	<p>SU14</p>  <p>13x</p> <p>Ø22</p>	<p>SU15</p>  <p>6x</p> <p>M16 DIN 934</p>	<p>SU16</p>  <p>1x</p> <p>M16 DIN 125A</p>
<p>SU17</p>  <p>15x</p> <p>6 x 60mm</p>	<p>SU18</p>  <p>15x</p> <p>Ø8mm</p>	<p>SU18b</p>  <p>1x</p> <p>Ø6mm</p>	<p>SU21</p>  <p>2x</p> <p>M16 DIN 6334</p>	<p>SU22b</p>  <p>48x</p> <p>Ø5 x 30 mm</p>
<p>SU23</p>  <p>8x</p> <p>6 x 30mm</p>	<p>SU24</p>  <p>55x</p> <p>4,2 x 19mm</p>	<p>SU25</p>  <p>1x</p>	<p>SU26</p>  <p>1x</p> <p>Ø4 x 50 mm</p>	<p>SU27</p>  <p>1x</p> <p>M5 DIN 562</p>
<p>SU28</p>  <p>1x</p> <p>M5 x 6 mm</p>				

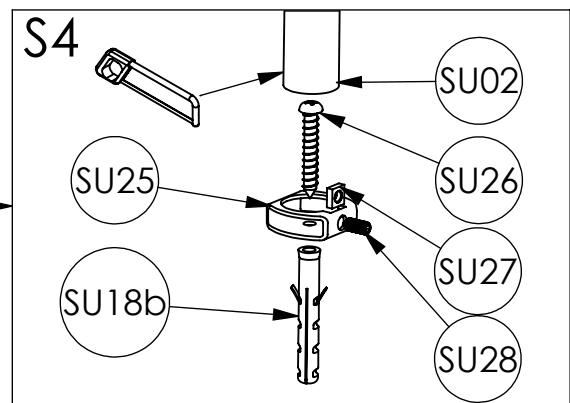
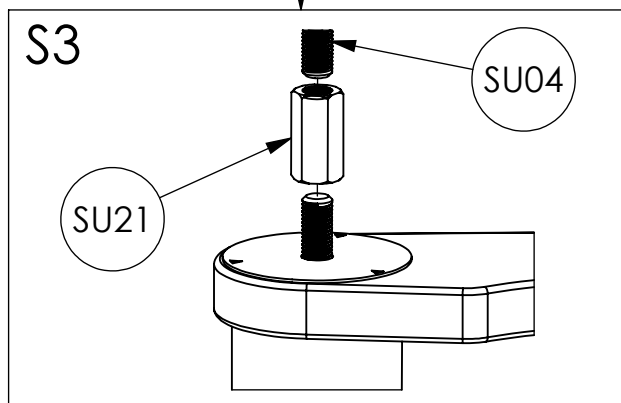
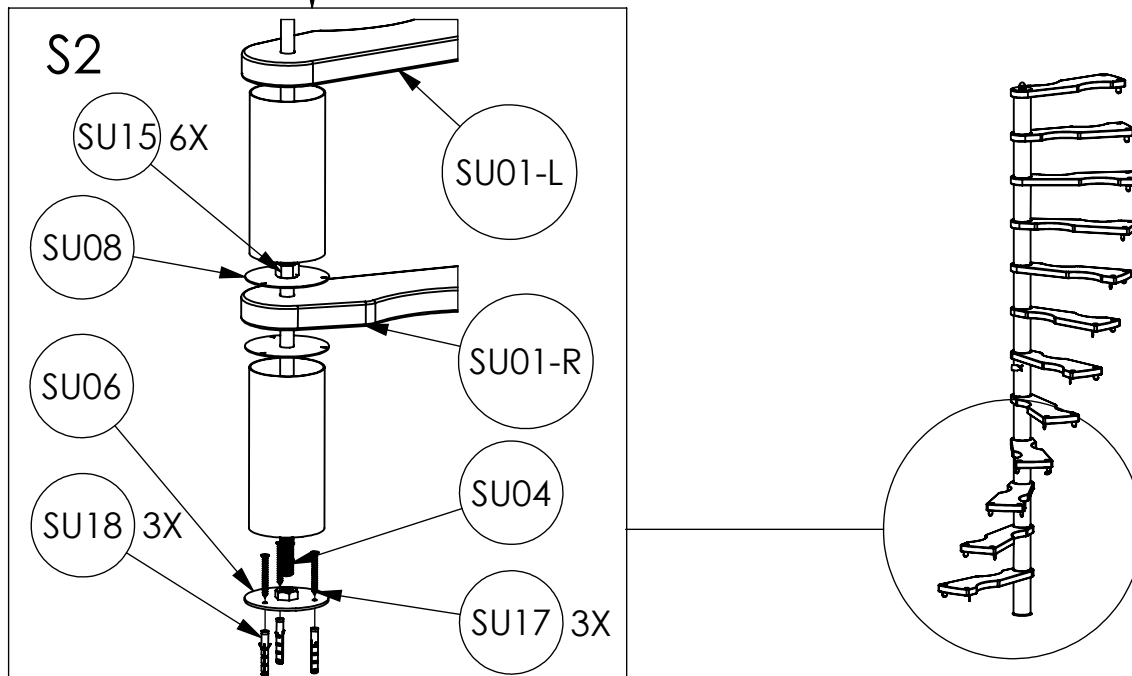
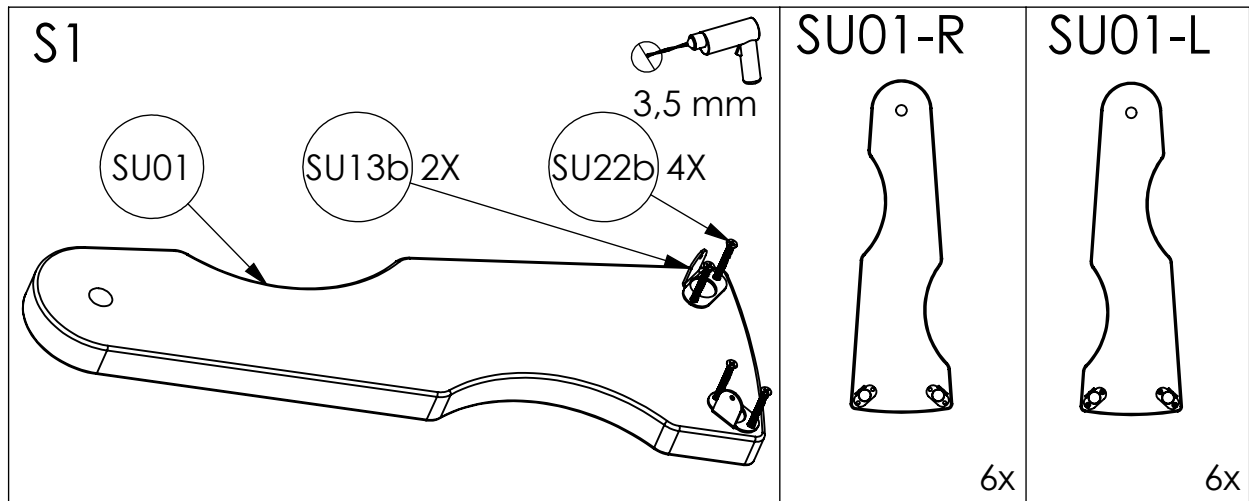

3

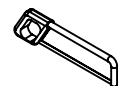
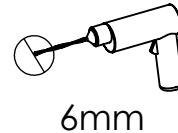
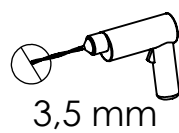
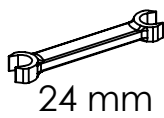
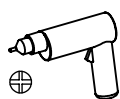
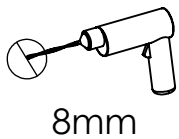

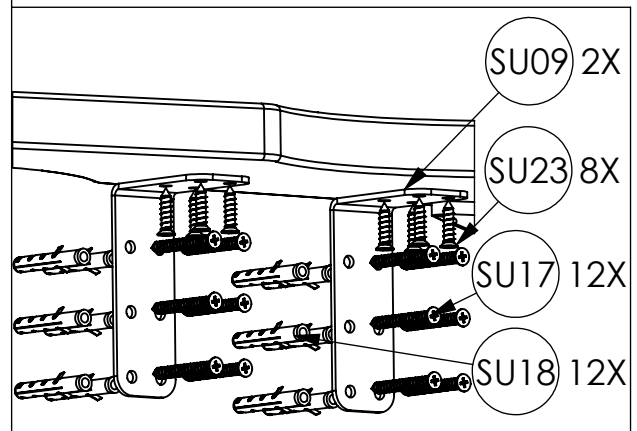
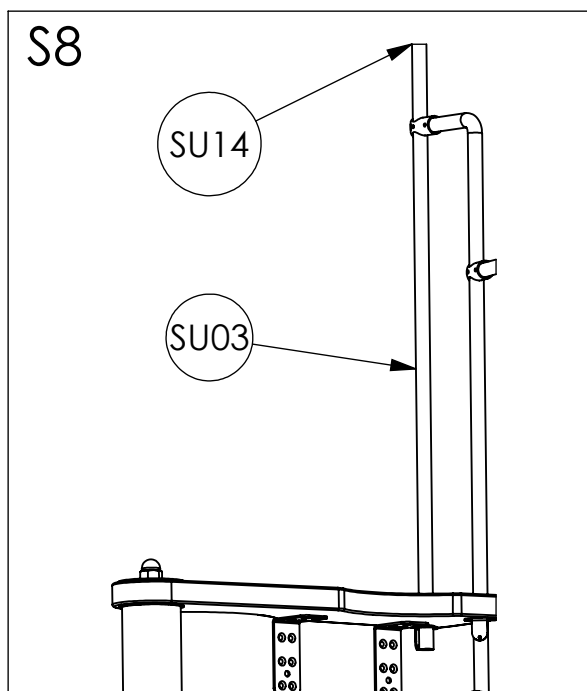
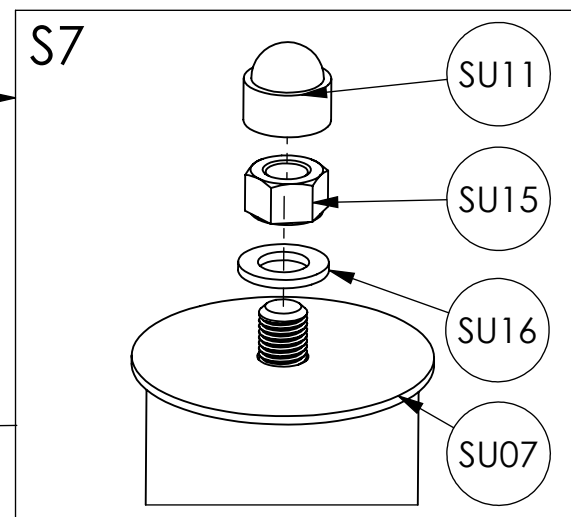
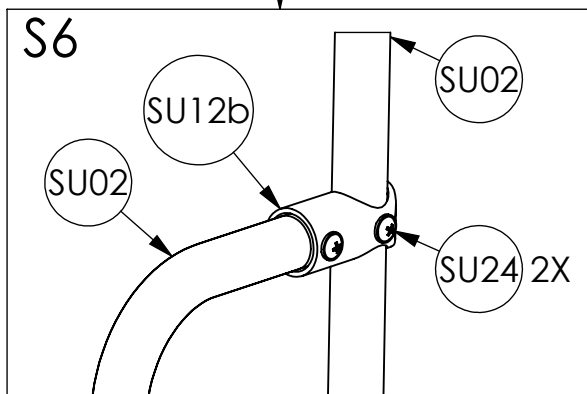
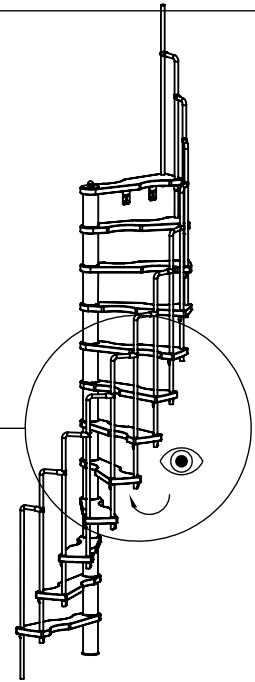
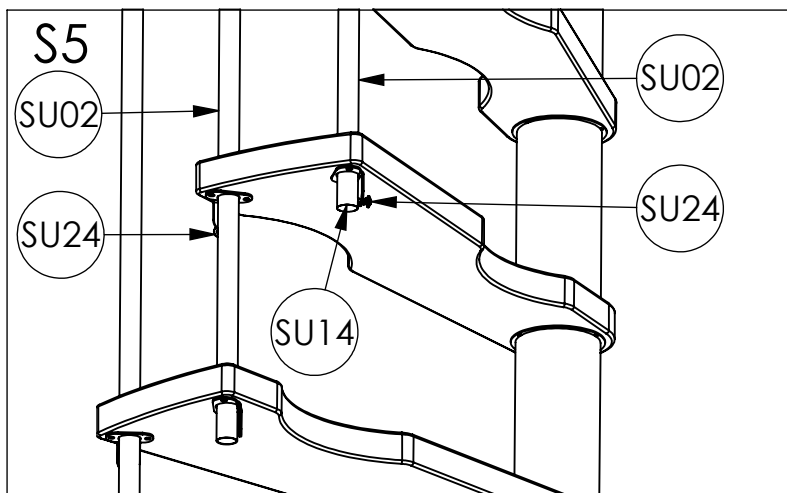

4

