

# Lisa 44-C XL

Wandaußenmaß: 390 x 390 cm

Bohlenstärke: 44 mm



Vom Kunden farblich behandelt.

Kontrolliert durch:

Achtung: Alle angegebenen Maße sind ca.-Maße!

# 3D-Darstellung Lisa 44-C XL

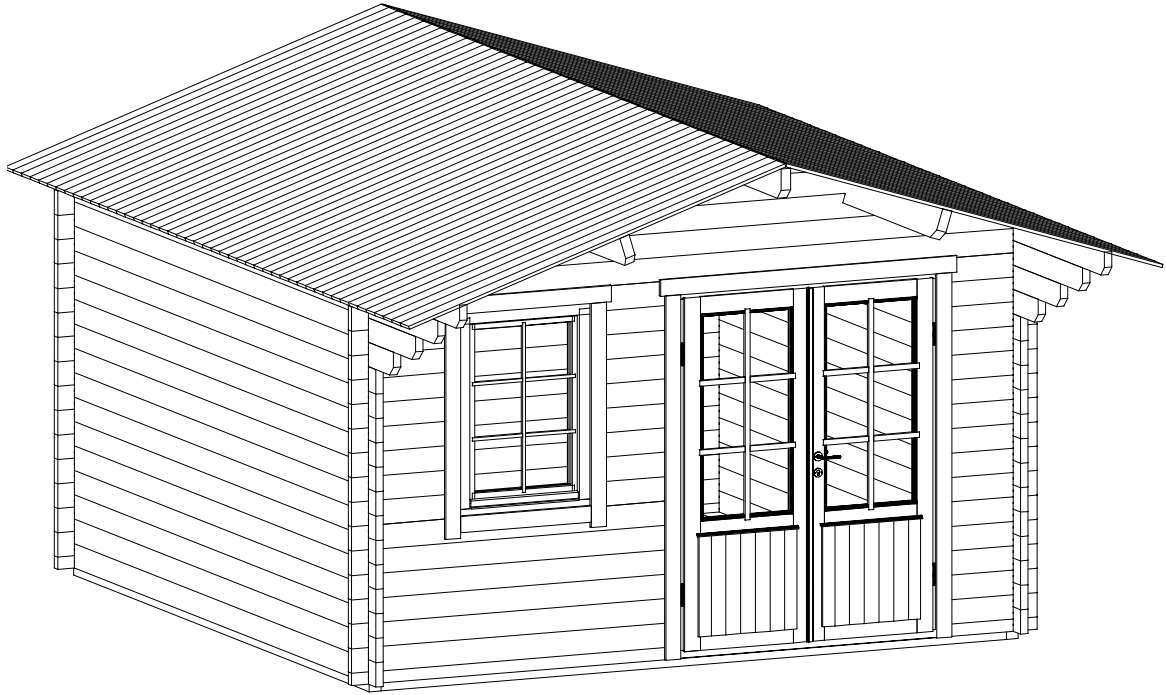

# Grundriss Lisa 44-C XL

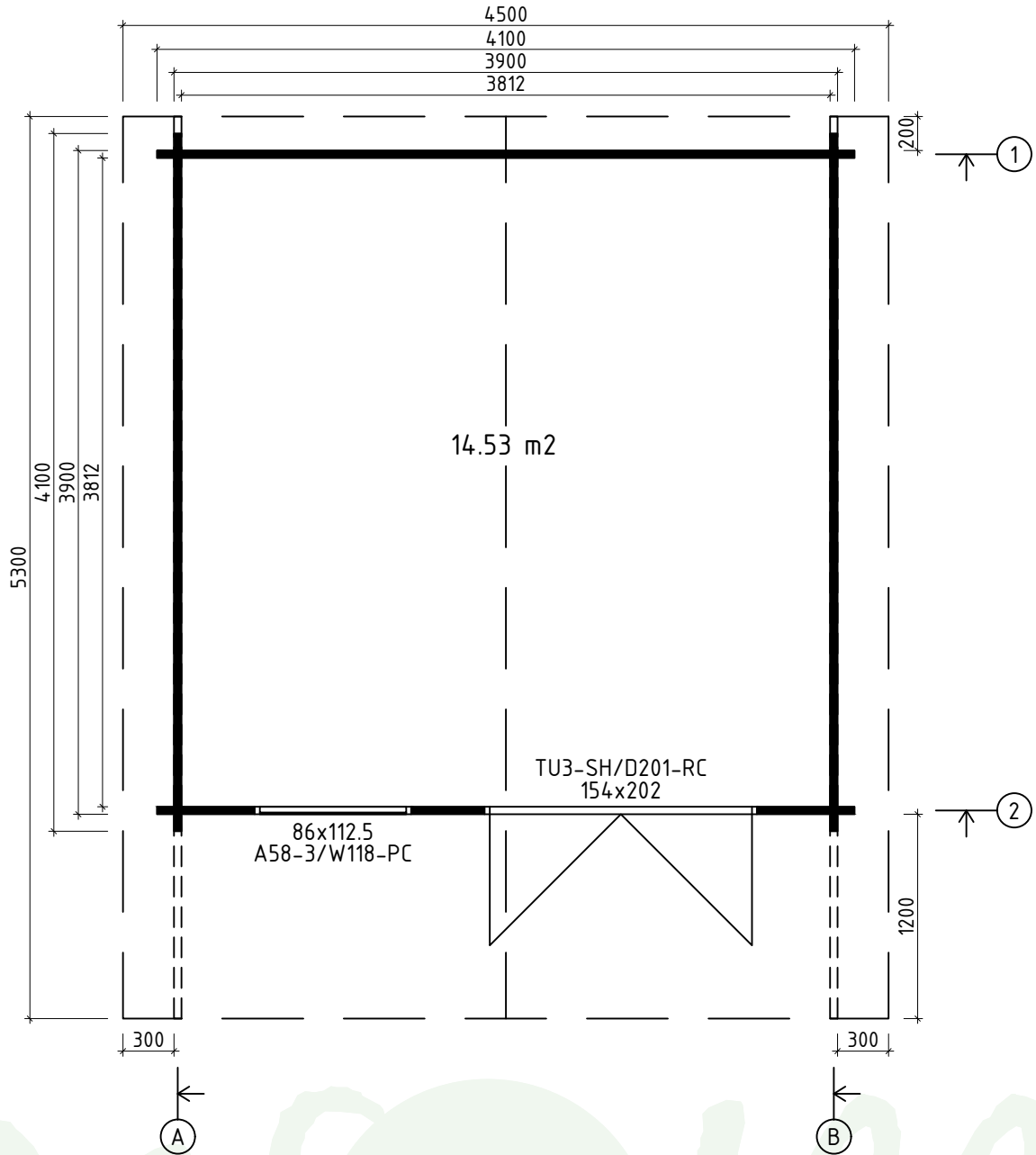

Q4 – Qualitätsklasse für Fenster und Türen





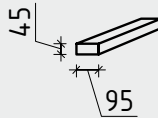
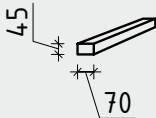
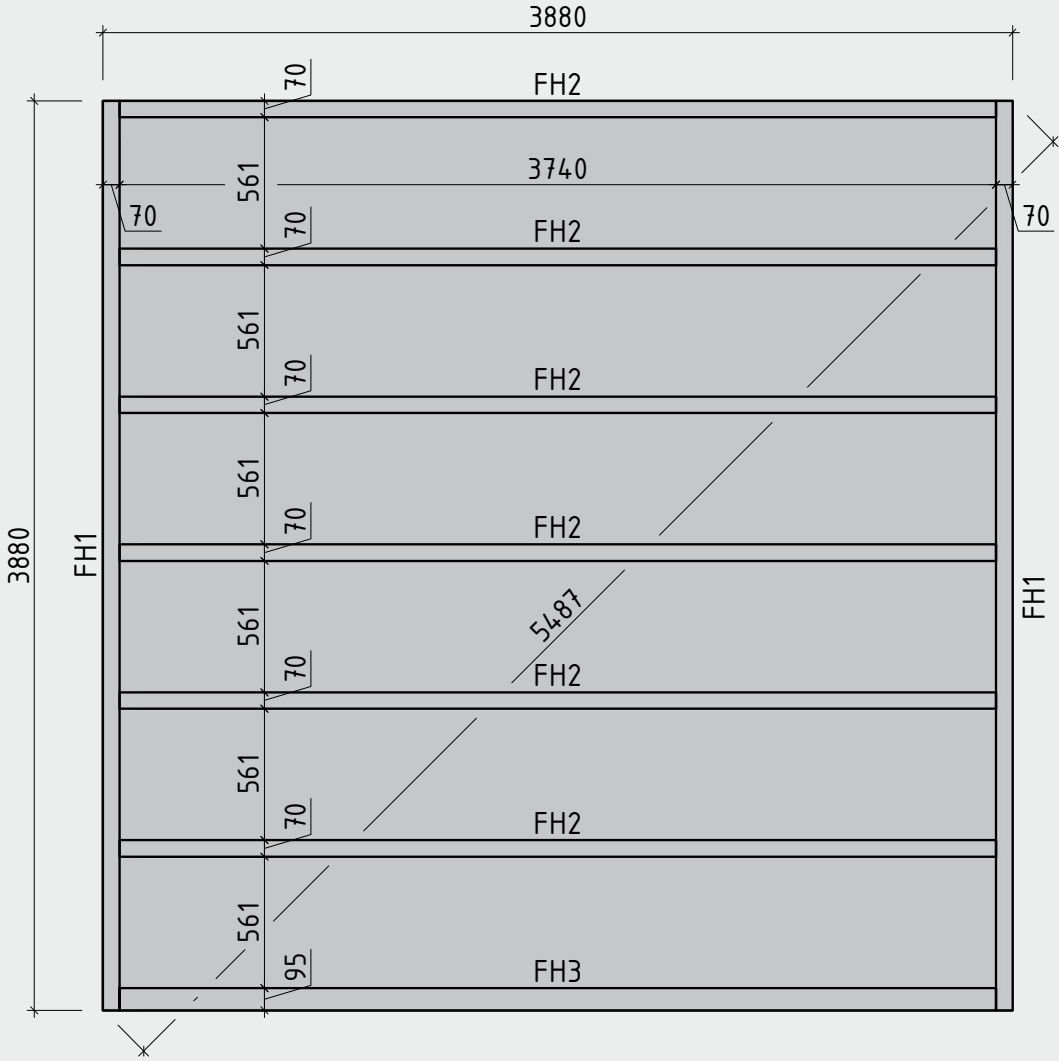





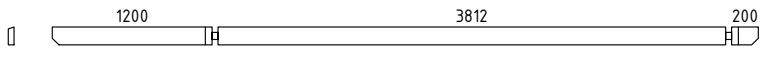
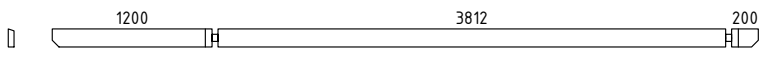

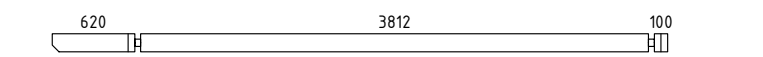
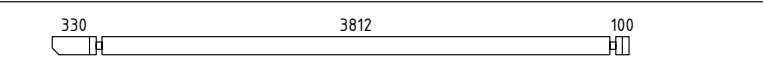
# Lagerholzplan und Fundamentplan Lisa 44-C XL

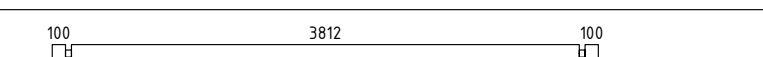
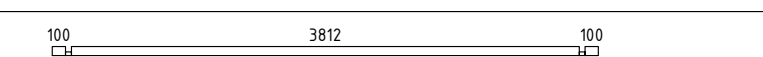
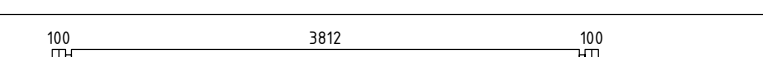
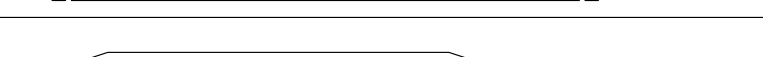
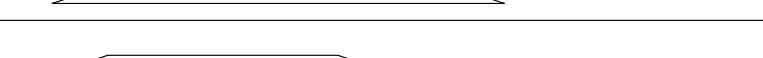
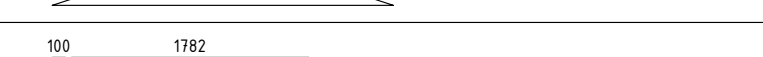
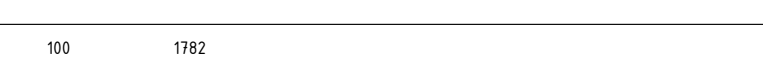
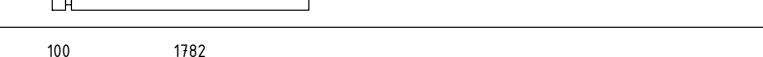
Wir empfehlen als Fundament für Ihr Gartenhaus eine vollflächig, festgegründete gepflasterte oder betonierte Fläche.  
Wahlweise ist auch ein Punkt- oder Streifenfundament möglich.





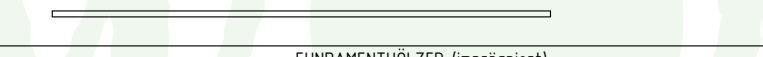
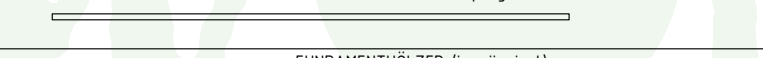

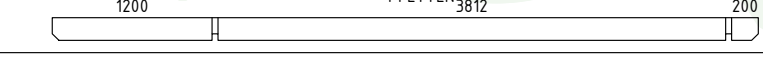





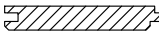





# Teileliste 1

## Lisa 44-C XL

Pos		Stck	Profil (mm)	Länge (mm)
001		1	44x135	5300
002		1	44x135	5300
003		2	44x135	4910
004		2	44x135	4620
005		2	44x135	4330
006		2	44x135	4100
007		1	44x135	4100
008		16	44x135	4100
009		1	44x68	4100
010		26	44x135	4100
011		2	44x135	3395
012		2	44x135	2561
013		1	44x68	1926
014		5	44x135	1926
015		1	44x135	1926
016		2	44x135	1726
017		1	44x68	574
018		24	44x135	574
019		9	44x135	432
020		4	44x135	422
FH3	FUNDAMENTHÖLZER (imprägniert) 	1	95x45	3740
FH1	FUNDAMENTHÖLZER (imprägniert) 	2	70x45	3880
FH2	FUNDAMENTHÖLZER (imprägniert) 	6	70x45	3740
PF1	PFETTEN 	3	58x170	5300
	DACHBRETTER 	94+1	113x18	2365

# Teileliste 2

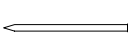
## Lisa 44-C XL

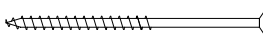
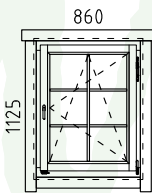
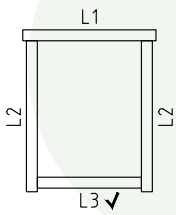
Pos		Stck	Profil (mm)	Länge (mm)
	FUSSBODENBRETTER 	34+1	113x18	3807
	FUSSBODENLEISTEN  ✓		18x40	16,0 lfm
G02-1	GIEBELBRETTER 18x120 17,9°  ✓	4	18x120	2445
G06-1	GIEBELDECKLEISTEN 18x58  ✓	4	18x58	2445
T01-1	TRAUFENBRETTER 18x95 	2	18x95	5300
T06-1	TRAUFENLEISTEN 18x40  ✓		18x40	11,0 lfm
GS	Giebelsegment 	2		
SH	Schlaghölzer 	3		
ML1	Metallstange 	1	D10	1440
KL1	Gewindestange M8 	4	M8	2000
KL2	Gewindestange M8 	4	M8	325
KV M UT M8	Mutter M8 	8	M8	
KV S EIB M8X25	U-Scheibe M8 Ø25 	8	M8	
KV MU TJ M8	Befestigungsmutter M8 	4	M8	
NG04	NÄGEL 2.5x50 Dachbretter Fußbodenbretter 	1040		
SR32	SCHRAUBEN 3.0x30 Fußbodenleisten Traufenleisten 40x18 	54		
SR37	SCHRAUBEN 3.5x45 Giebelbretter, Traufenbretter Giebelsegment, Fenster- und Türleisten 	114		
SR57	SCHRAUBEN 5.0x100 Fundamenthölzer 	36		
	FENSTER <u>Q4</u>   A58-3/W118-PC L1 18x95 L=1100mm 2x L2 18x95 L=1245mm 4x L3 18x95 L=860mm 2x ✓	1	W4-S44P-06C-08601125	

# Teileliste 3

## Lisa 44-C XL

Pos		Stck	Profil (mm)	Länge (mm)
	<p>TÜR Q4 <span style="float: right;">D4-D44R-56C-15402020</span></p>  <p>TU3-SH/D201-RC</p> <p>L1 18x95 L=1780mm 2x L2 18x95 L=2020mm 4x ✓</p> <p>DIN rechts</p>	1		
	<p>✓ - bitte selber anpassen (falls nötig)!</p>			

# Wandplan A und B Lisa 44-C XL

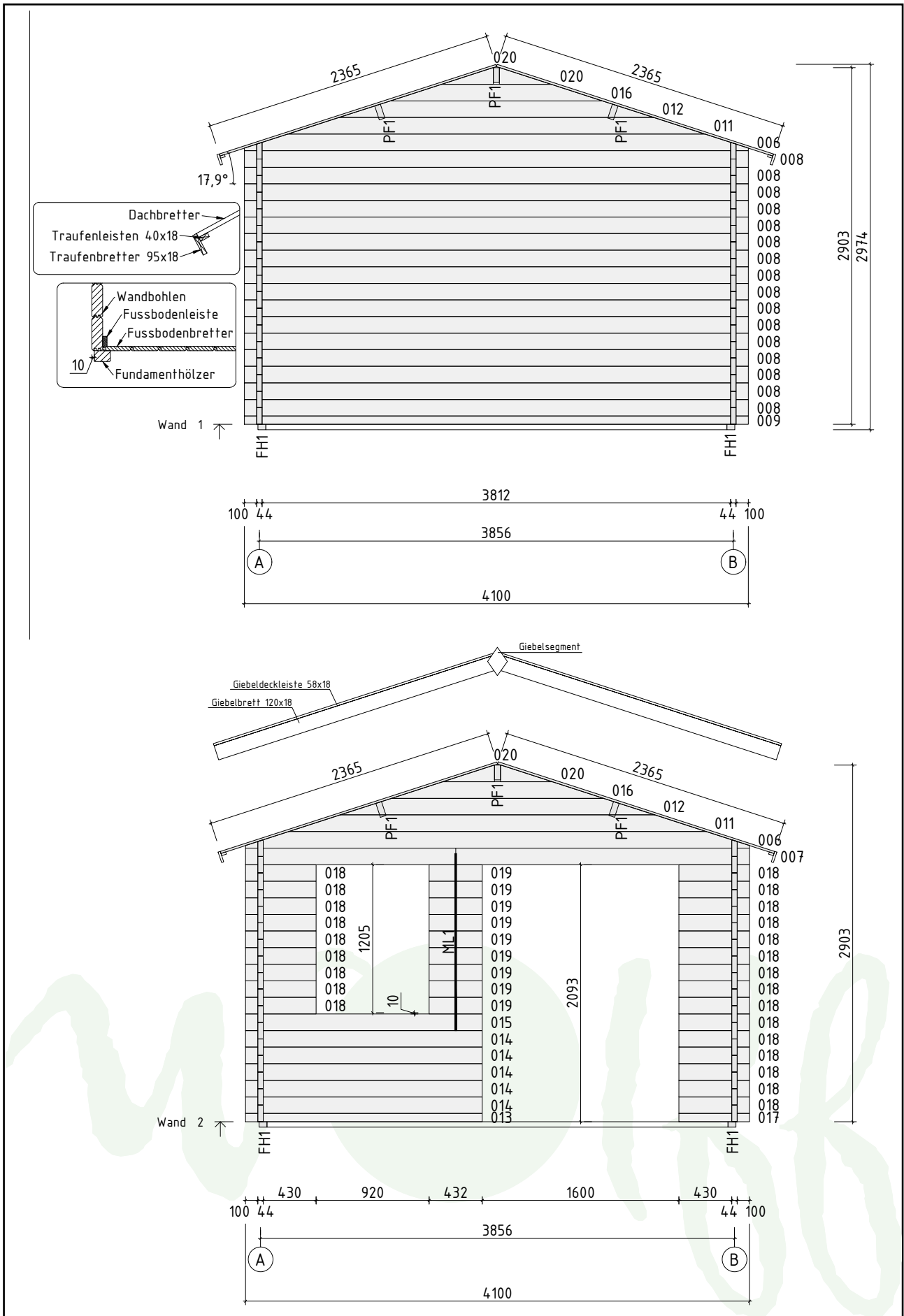



# Wandplan 1 und 2

## Lisa 44-C XL

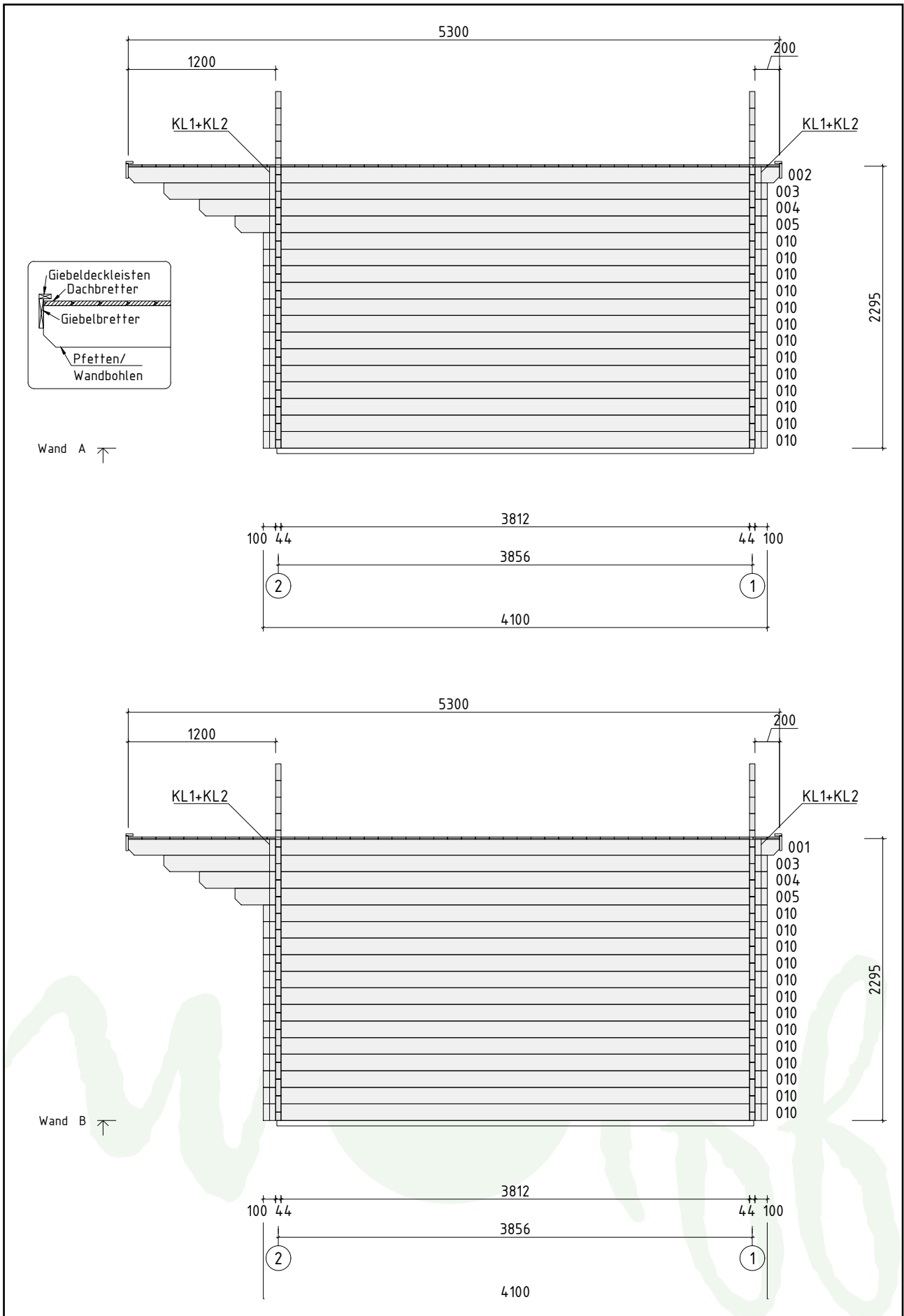

# Details

## Lisa 44-C XL

Akna tüüp / Fenster typ / Window type - A68  
(GH+ / SH)

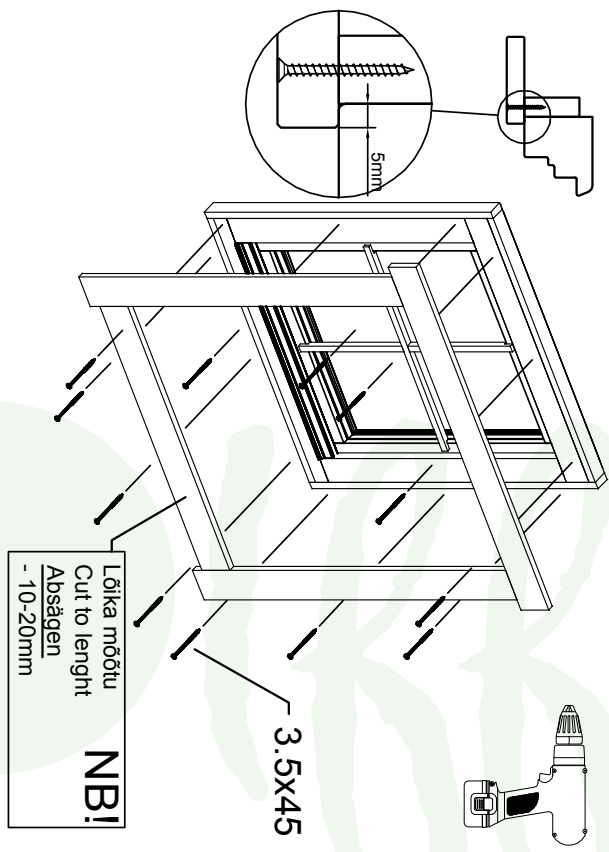
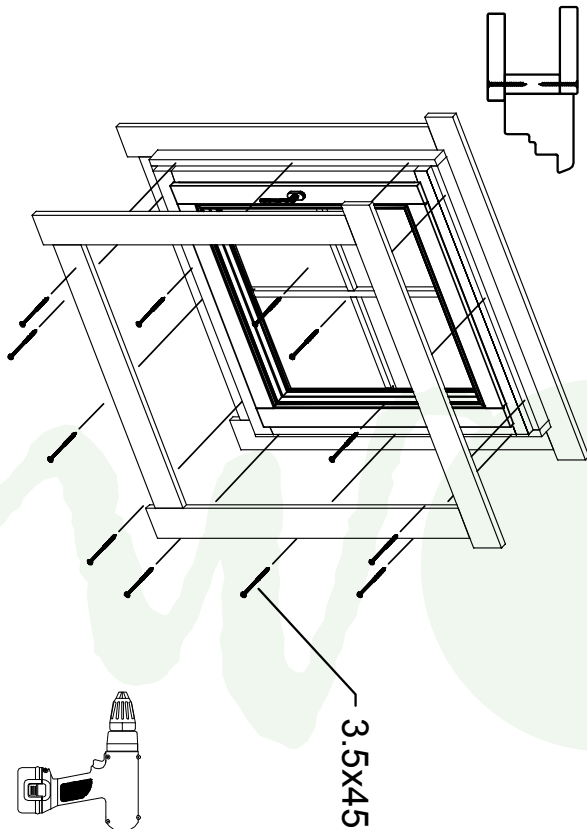
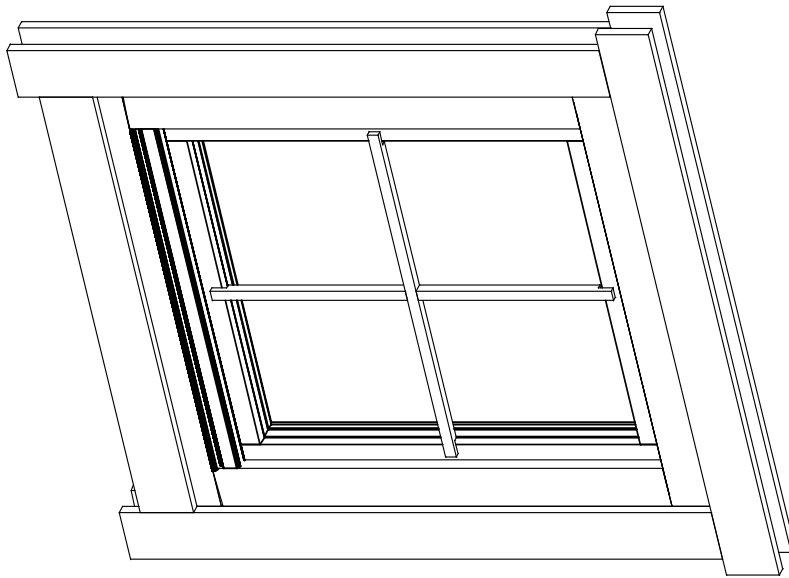

# Details

## Lisa 44-C XL

Ukse montaaž / Tur montage / Door assembly  
(GH+ / SH)

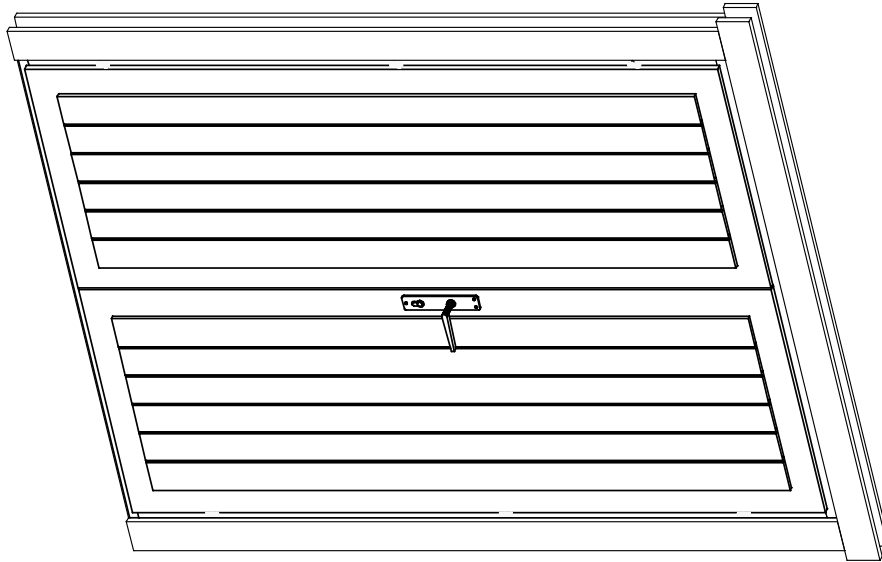

# Details

## Lisa 44-C XL

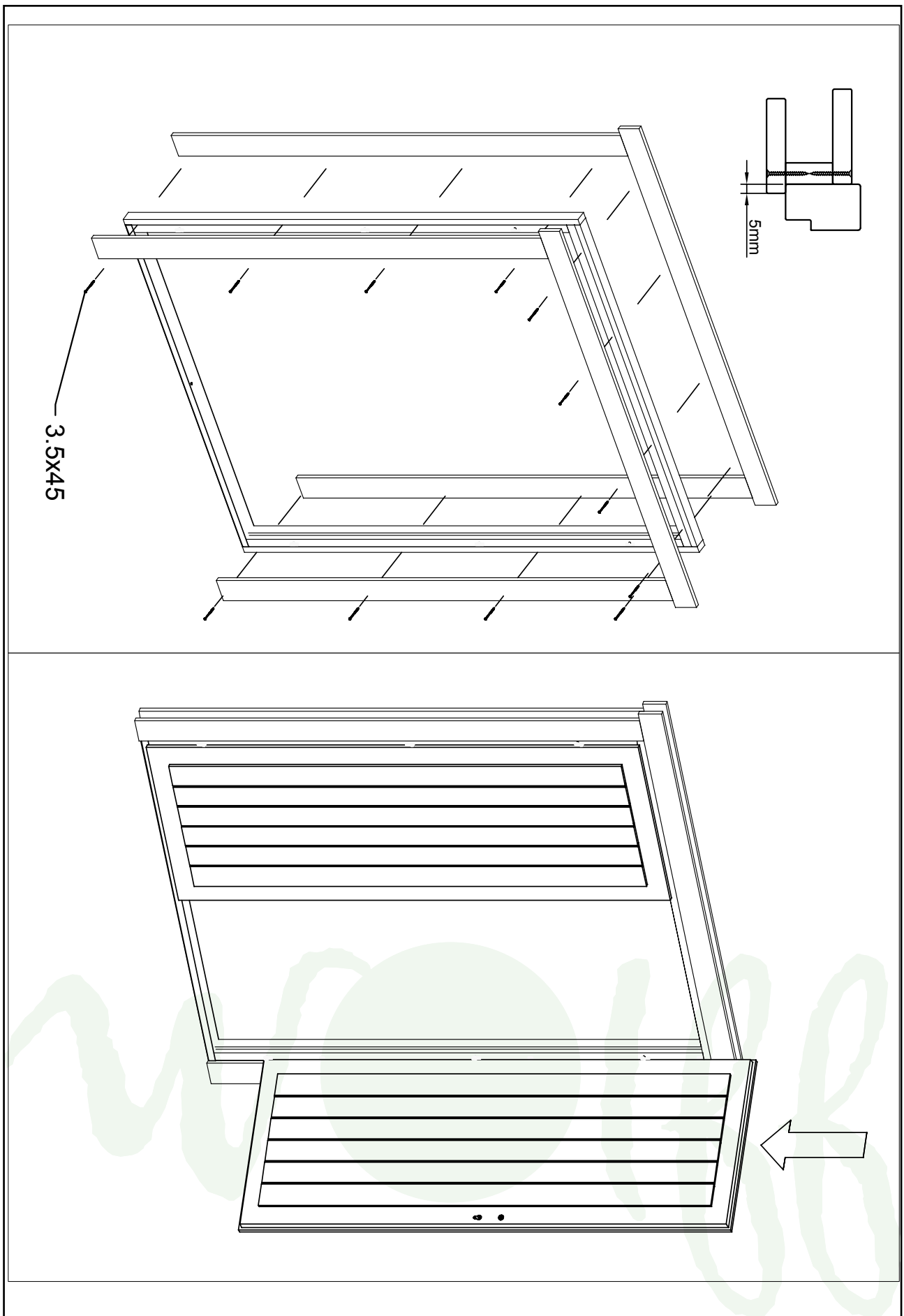

# Details

## Lisa 44-C XL

