

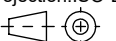

local article number: 320717

 ACO Hochbau Vertrieb GmbH 24755 Rendsburg, Postfach 320 Tel. +49 4331 354-410 Fax. +49 4331 354-360 www.aco-hochbau.de	drawing-no.: <b>1096991-M</b>	index: <b>001</b>	documenttype: <b>marketing drw.</b>
	created by: <b>Isigel</b>	reviewed by: <b>mwandkowski</b>	projection: ISO-E 
title: <b>ACO Profiline          Endplate RF_50x100_stainless steel          Stirnwand RF_50x100_Edelstahl</b>			<b>serial-released</b>
<small>The reproduction, distribution and utilization of this document as well as the communication of its contents to others without express authorization is prohibited. Offenders will be held liable for the payment of damages. All rights reserved in the event of the grant of a patent, utility model or design. Observe copyright by ISO 16016</small>			release date: <b>05.02.2021</b>
			sheet: <b>1/1</b>

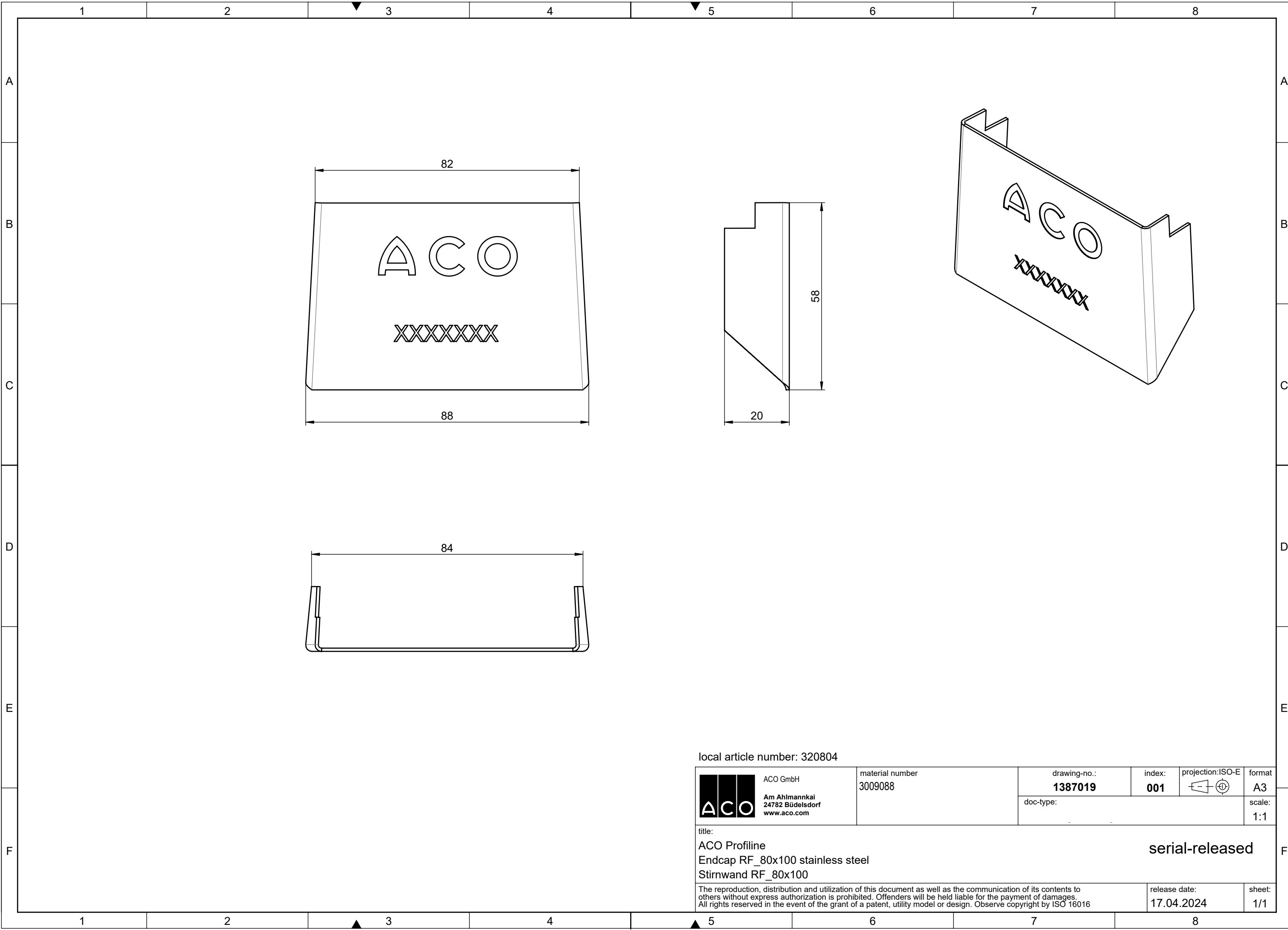

local article number: 320804

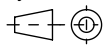
 ACO GmbH Am Ahlmannkai 24782 Büdelsdorf www.aco.com	material number 3009088	drawing-no.: <b>1387019</b>	index: <b>001</b>	projection: ISO-E 	format A3
	doc-type:				scale: 1:1
title: ACO Proflin Endcap RF_80x100 stainless steel Stirnwand RF_80x100					serial-released
The reproduction, distribution and utilization of this document as well as the communication of its contents to others without express authorization is prohibited. Offenders will be held liable for the payment of damages. All rights reserved in the event of the grant of a patent, utility model or design. Observe copyright by ISO 16016				release date: 17.04.2024	sheet: 1/1

DWG 1387019

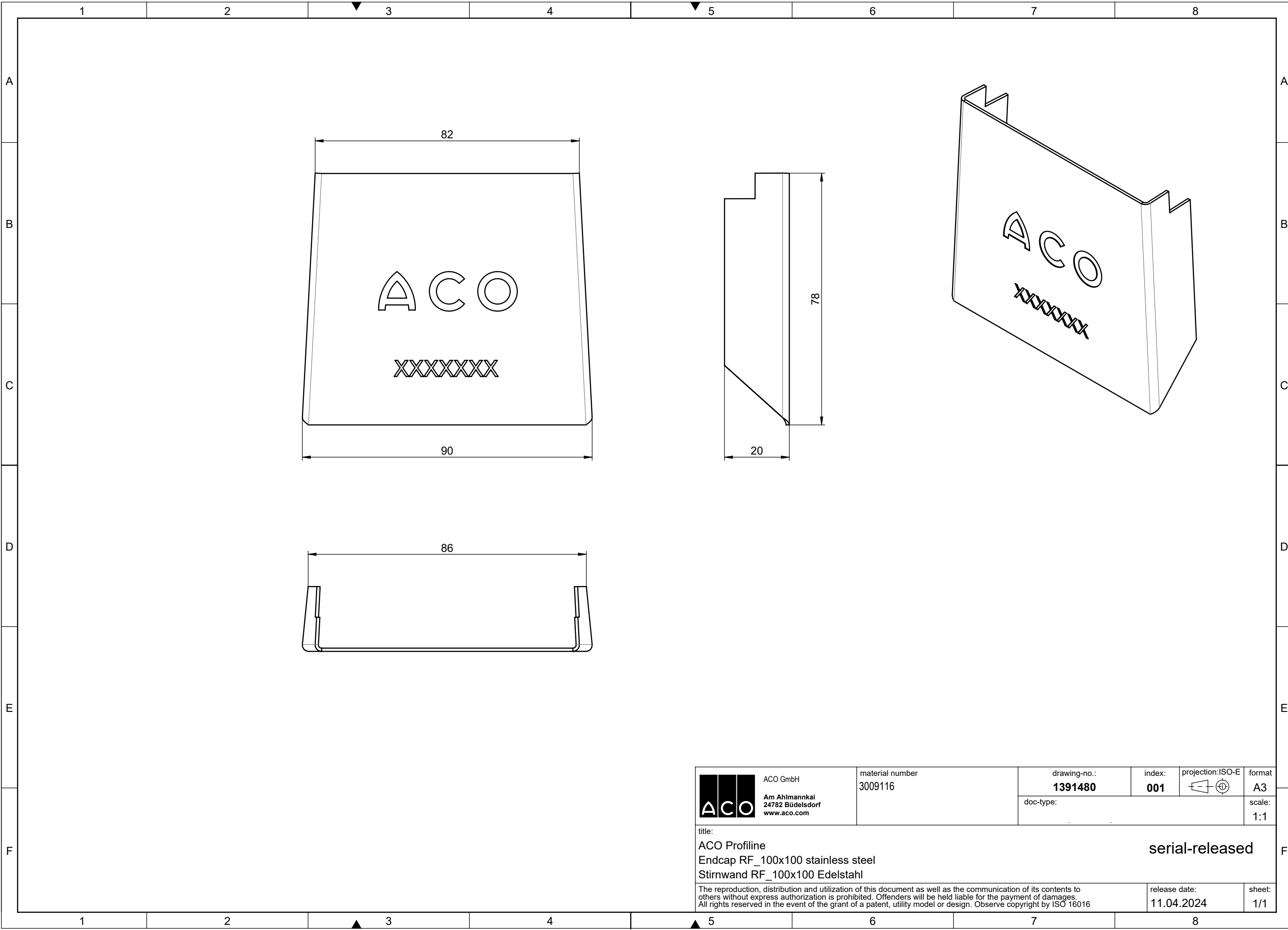

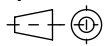
 ACO GmbH Am Ahlmannkai 24782 Büdelsdorf www.aco.com	material number 3009116	drawing-no.: <b>1391480</b>	index: <b>001</b>	projection: ISO-E 	format A3
	doc-type:				scale: 1:1
title: ACO Profiline Endcap RF_100x100 stainless steel Stirnwand RF_100x100 Edelstahl					serial-released
The reproduction, distribution and utilization of this document as well as the communication of its contents to others without express authorization is prohibited. Offenders will be held liable for the payment of damages. All rights reserved in the event of the grant of a patent, utility model or design. Observe copyright by ISO 16016			release date: 11.04.2024	sheet: 1/1	

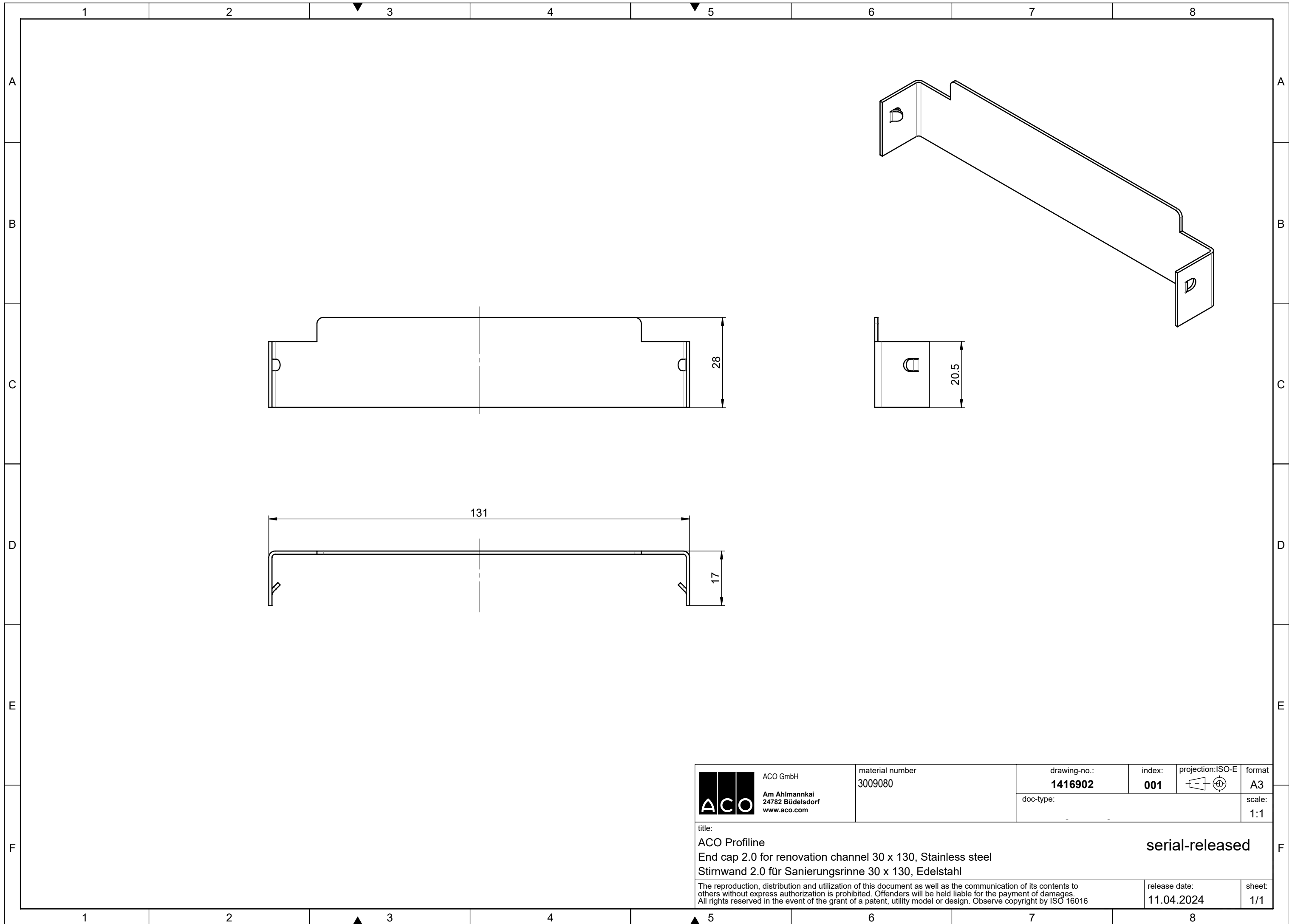

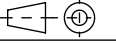
 <b>ACO</b> Am Ahlmannkai 24782 Büdelsdorf www.aco.com	material number 3009080	drawing-no.: <b>1416902</b>	index: <b>001</b>	projection: ISO-E 	format <b>A3</b>
	doc-type:				scale: <b>1:1</b>
title: <b>ACO Proffline</b> <b>End cap 2.0 for renovation channel 30 x 130, Stainless steel</b> <b>Stirnwand 2.0 für Sanierungsrinne 30 x 130, Edelstahl</b>					<b>serial-released</b>
<small>The reproduction, distribution and utilization of this document as well as the communication of its contents to others without express authorization is prohibited. Offenders will be held liable for the payment of damages. All rights reserved in the event of the grant of a patent, utility model or design. Observe copyright by ISO 16016</small>				release date: <b>11.04.2024</b>	sheet: <b>1/1</b>

DWG 1416902

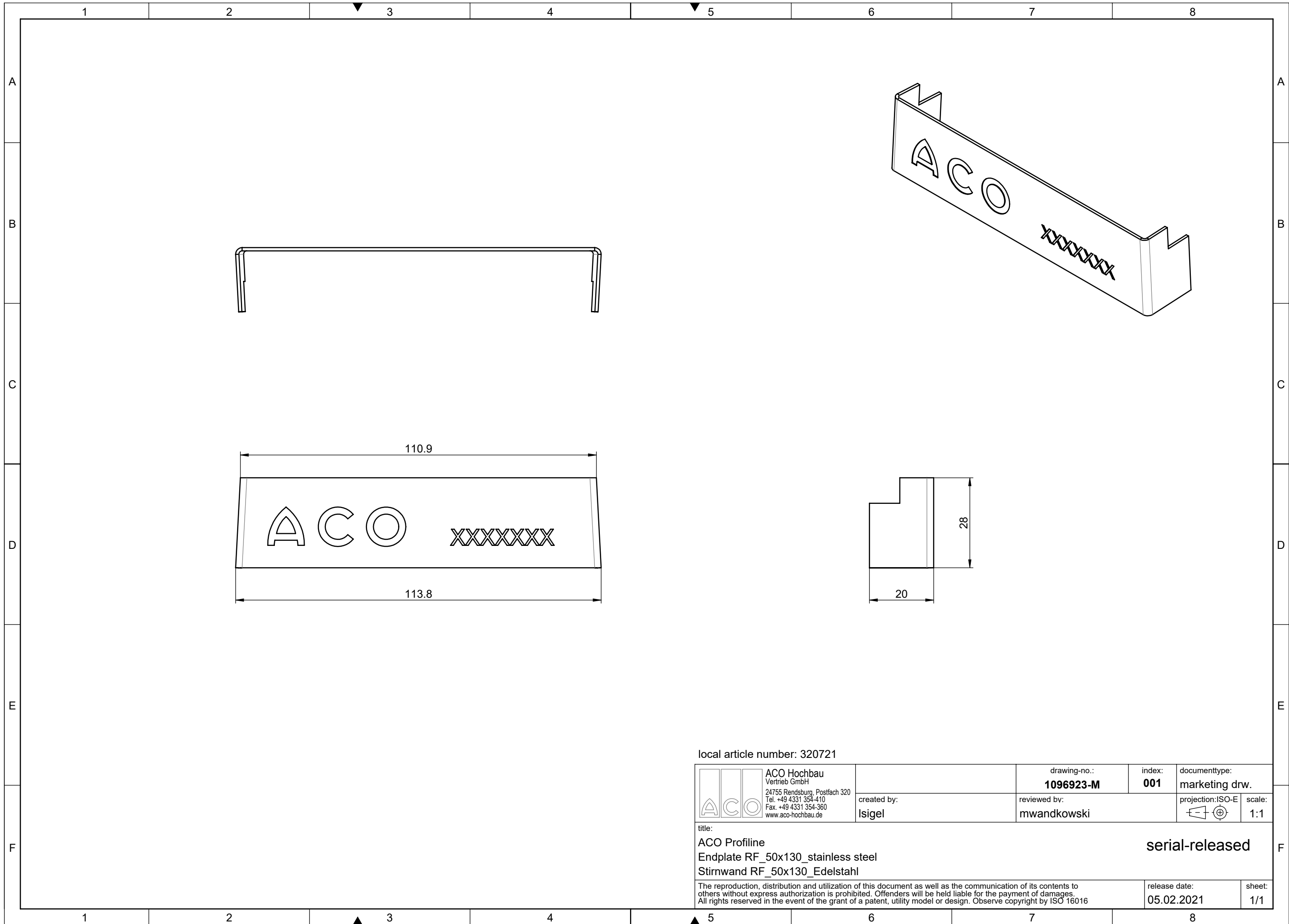

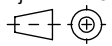

local article number: 320721

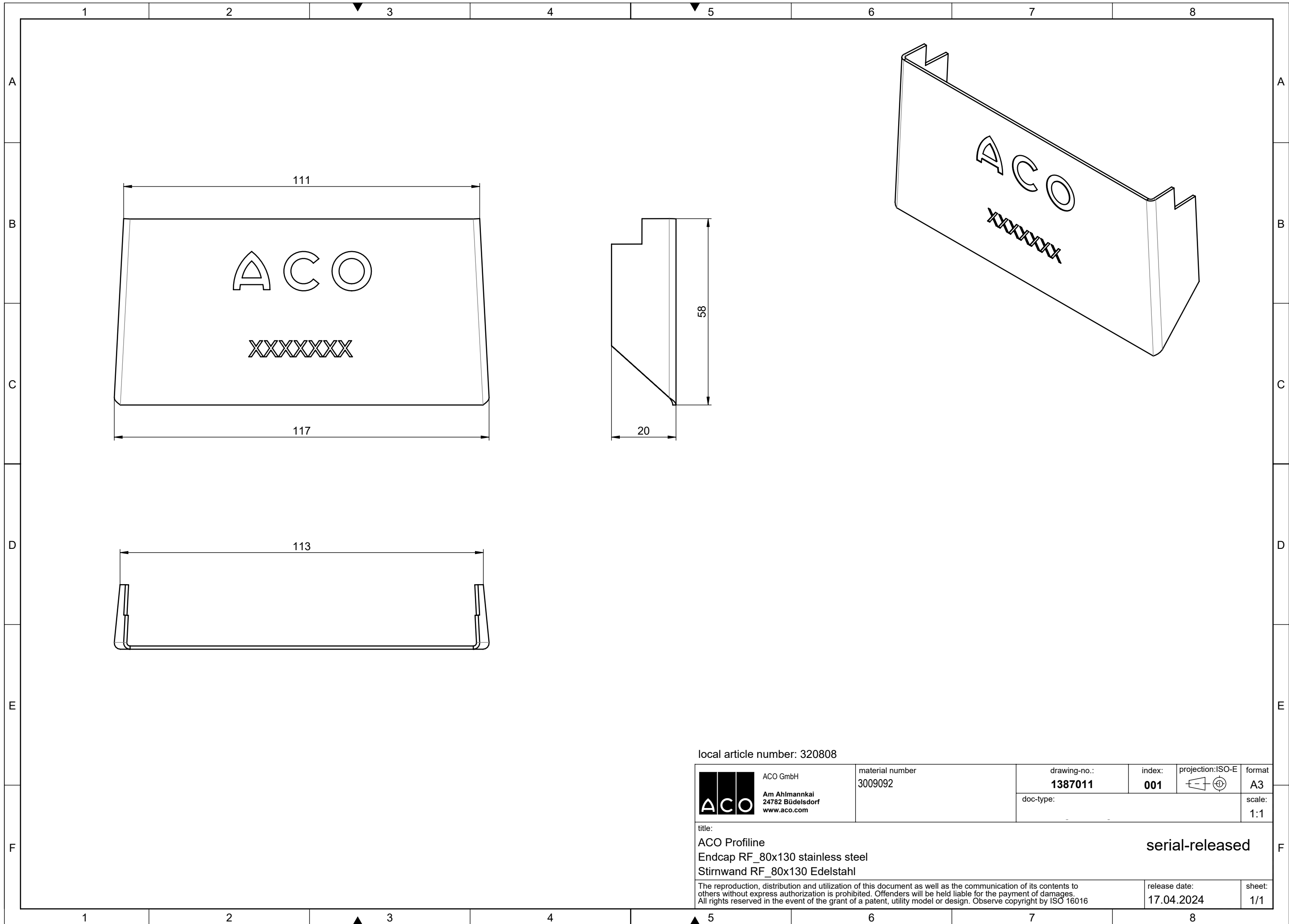
 ACO Hochbau Vertrieb GmbH 24755 Rendsburg, Postfach 320 Tel. +49 4331 354-410 Fax. +49 4331 354-360 www.aco-hochbau.de	drawing-no.: <b>1096923-M</b>	index: <b>001</b>	documenttype: <b>marketing drw.</b>
	created by: <b>Isigel</b>	reviewed by: <b>mwandkowski</b>	projection: ISO-E 
title: <b>ACO Profiline          Endplate RF_50x130_stainless steel          Stirnwand RF_50x130_Edelstahl</b>			<b>serial-released</b>
<small>The reproduction, distribution and utilization of this document as well as the communication of its contents to others without express authorization is prohibited. Offenders will be held liable for the payment of damages. All rights reserved in the event of the grant of a patent, utility model or design. Observe copyright by ISO 16016</small>			release date: <b>05.02.2021</b>
			sheet: <b>1/1</b>



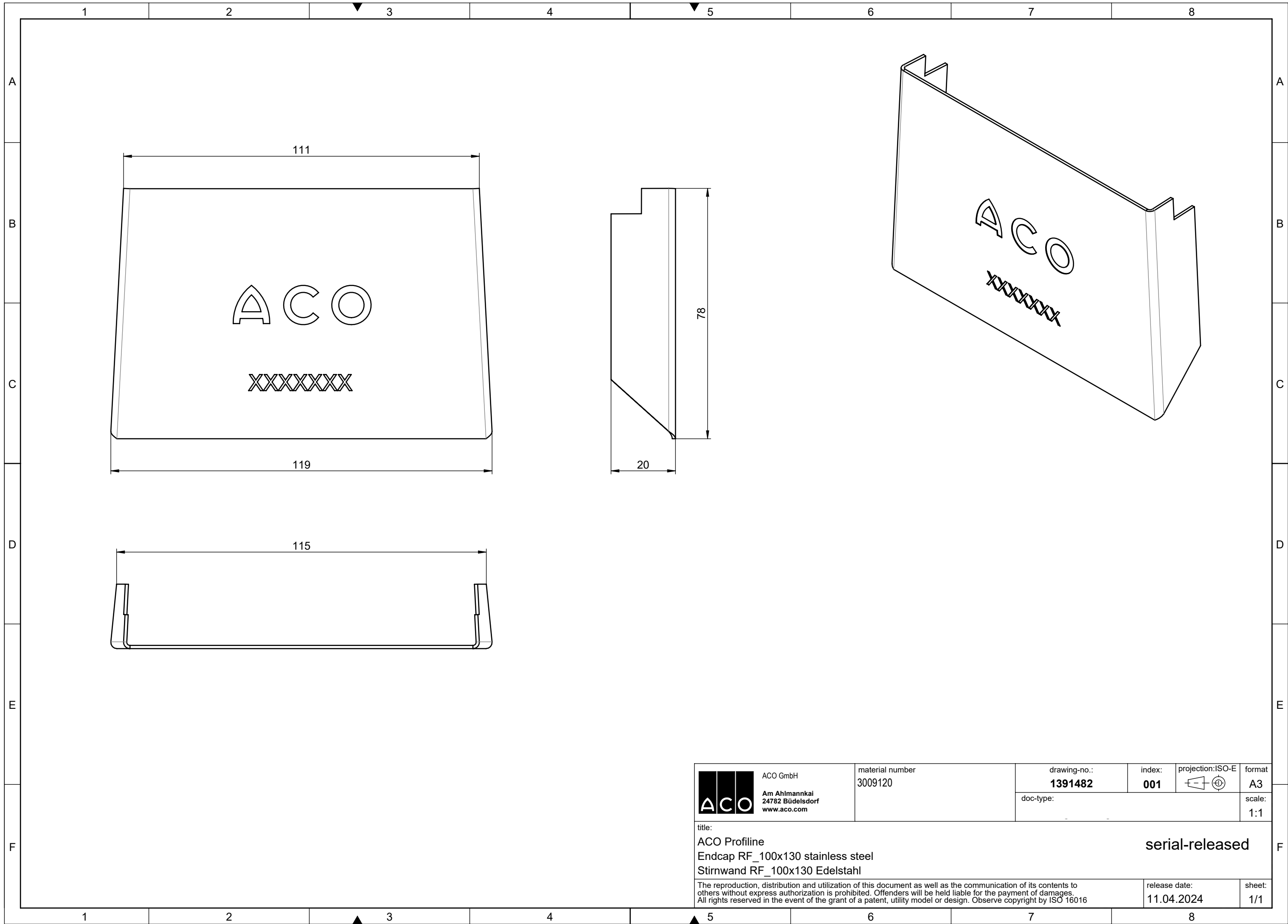

local article number: 320808

 ACO GmbH Am Ahlmannkai 24782 Büdelsdorf www.aco.com	material number 3009092	drawing-no.: <b>1387011</b>	index: <b>001</b>	projection: ISO-E 	format <b>A3</b>
	doc-type:				scale: 1:1
title: ACO Proffline Endcap RF_80x130 stainless steel Stirnwand RF_80x130 Edelstahl					serial-released
The reproduction, distribution and utilization of this document as well as the communication of its contents to others without express authorization is prohibited. Offenders will be held liable for the payment of damages. All rights reserved in the event of the grant of a patent, utility model or design. Observe copyright by ISO 16016				release date: 17.04.2024	sheet: 1/1

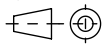

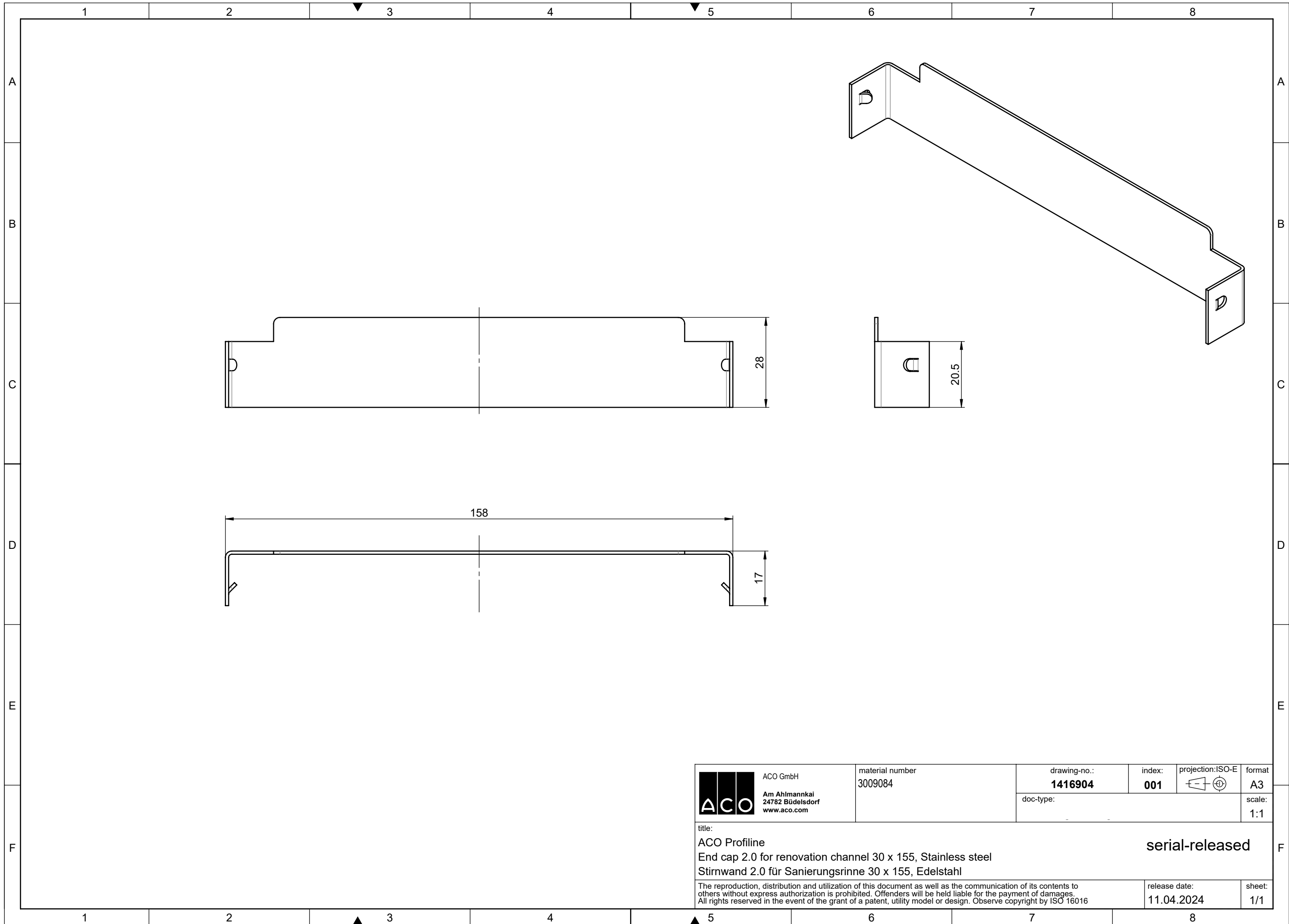
 ACO GmbH Am Ahlmannkai 24782 Büdelsdorf www.aco.com	material number 3009120	drawing-no.: <b>1391482</b>	index: <b>001</b>	projection: ISO-E 	format A3
	doc-type:				scale: 1:1
title: ACO Profiline Endcap RF_100x130 stainless steel Stirnwand RF_100x130 Edelstahl					serial-released
The reproduction, distribution and utilization of this document as well as the communication of its contents to others without express authorization is prohibited. Offenders will be held liable for the payment of damages. All rights reserved in the event of the grant of a patent, utility model or design. Observe copyright by ISO 16016				release date: 11.04.2024	sheet: 1/1

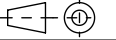

 ACO GmbH Am Ahlmannkai 24782 Büdelsdorf www.aco.com	material number 3009084	drawing-no.: <b>1416904</b>	index: <b>001</b>	projection: ISO-E 	format <b>A3</b>
	doc-type:				scale: <b>1:1</b>
title: <b>ACO Proffline</b> <b>End cap 2.0 for renovation channel 30 x 155, Stainless steel</b> <b>Stirnwand 2.0 für Sanierungsrinne 30 x 155, Edelstahl</b>					<b>serial-released</b>
The reproduction, distribution and utilization of this document as well as the communication of its contents to others without express authorization is prohibited. Offenders will be held liable for the payment of damages. All rights reserved in the event of the grant of a patent, utility model or design. Observe copyright by ISO 16016				release date: <b>11.04.2024</b>	sheet: <b>1/1</b>

DWG 1416904



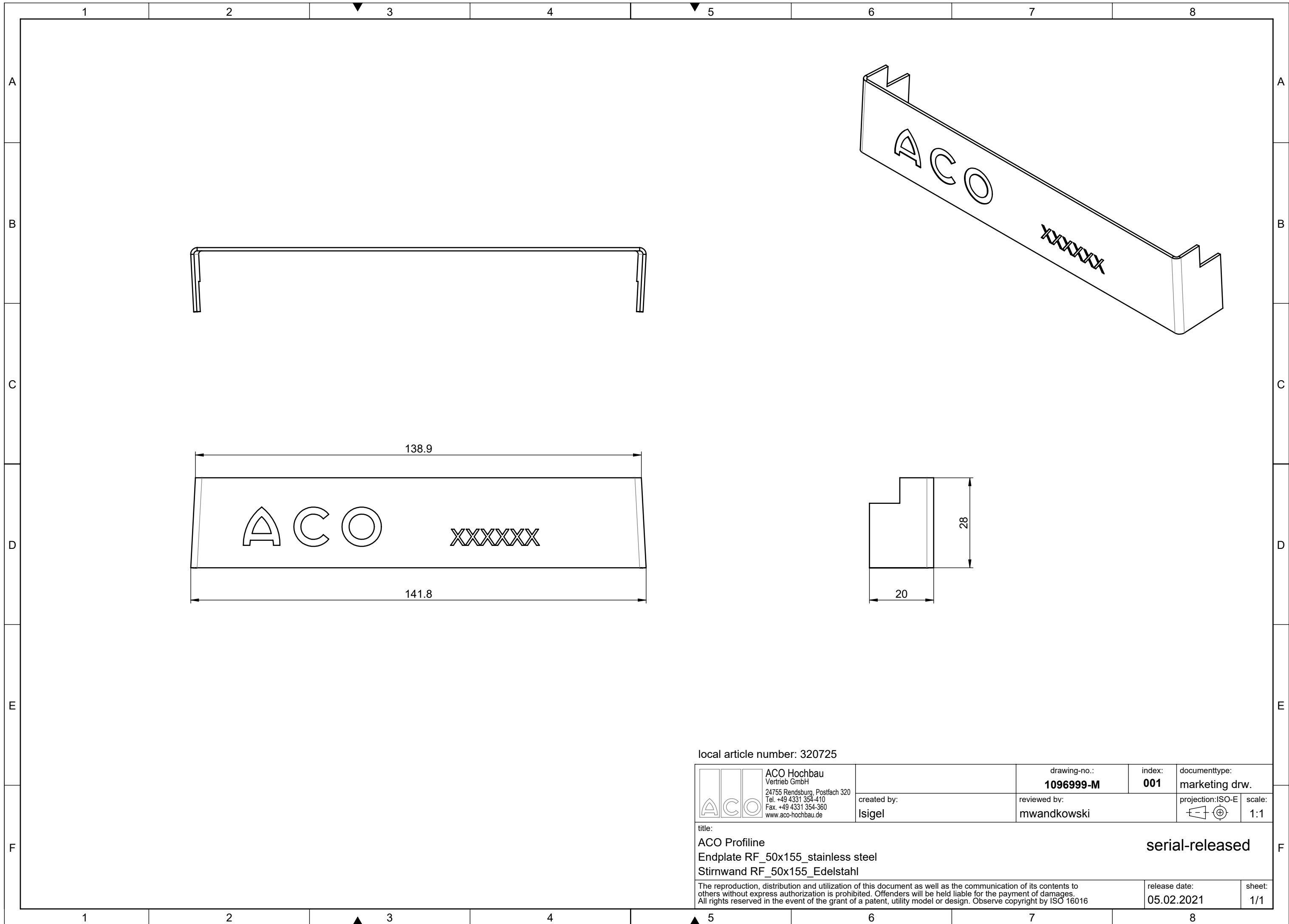

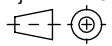

local article number: 320725

 ACO Hochbau Vertrieb GmbH 24755 Rendsburg, Postfach 320 Tel. +49 4331 354-410 Fax. +49 4331 354-360 www.aco-hochbau.de	drawing-no.: <b>1096999-M</b>	index: <b>001</b>	documenttype: <b>marketing drw.</b>
	created by: <b>Isigel</b>	reviewed by: <b>mwandkowski</b>	projection: ISO-E 
title: <b>ACO Profiline          Endplate RF_50x155_stainless steel          Stirnwand RF_50x155_Edelstahl</b>			<b>serial-released</b>
<small>The reproduction, distribution and utilization of this document as well as the communication of its contents to others without express authorization is prohibited. Offenders will be held liable for the payment of damages. All rights reserved in the event of the grant of a patent, utility model or design. Observe copyright by ISO 16016</small>			release date: <b>05.02.2021</b>
			sheet: <b>1/1</b>

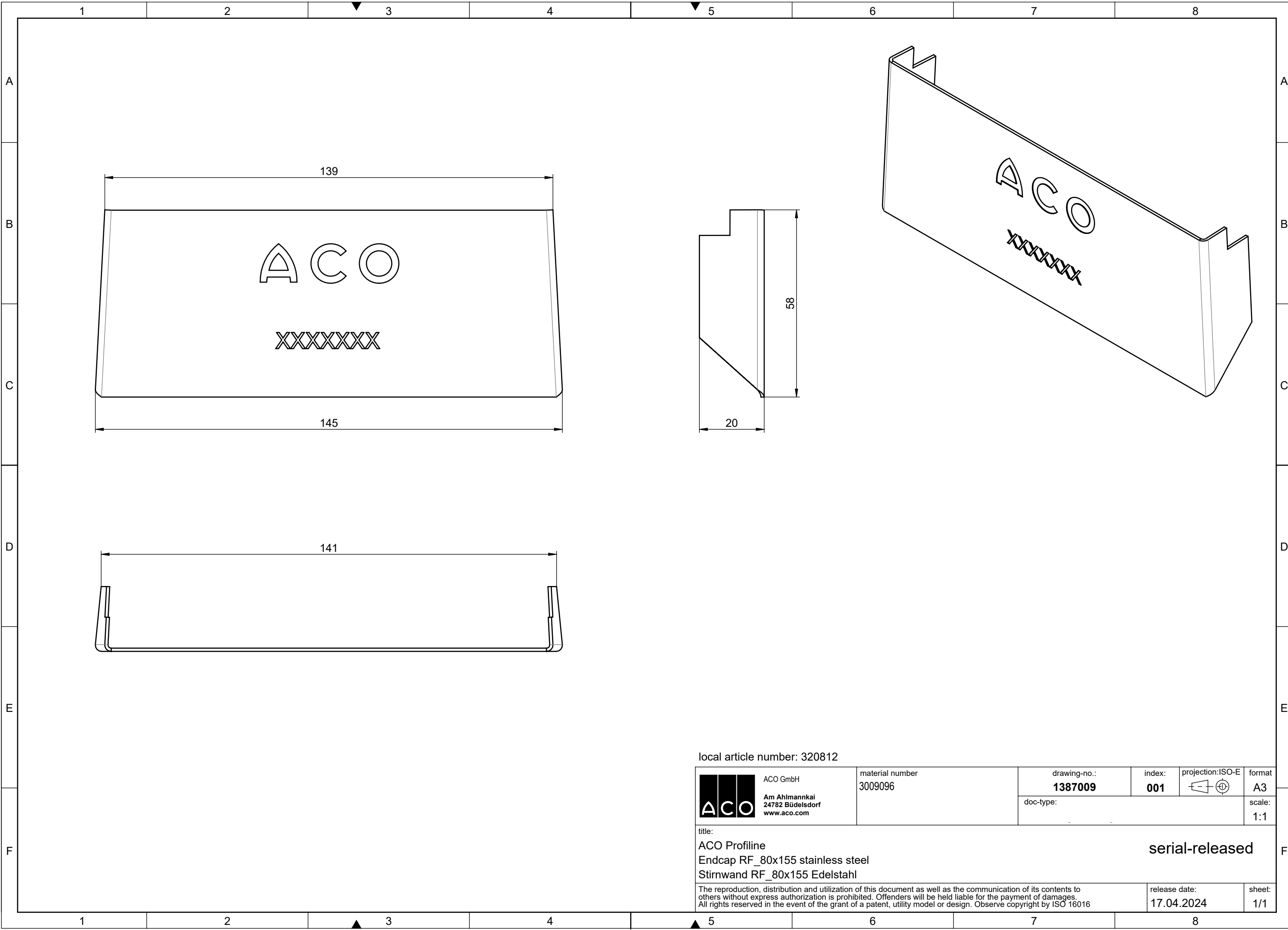
S:\dokus\2019-DIN-A3-Versatz.21

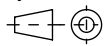

local article number: 320812

 ACO GmbH Am Ahlmannkai 24782 Büdelsdorf www.aco.com	material number 3009096	drawing-no.: <b>1387009</b>	index: <b>001</b>	projection: ISO-E 	format <b>A3</b>
	doc-type:				scale: <b>1:1</b>
title: ACO Proflin Endcap RF_80x155 stainless steel Stirnwand RF_80x155 Edelstahl					<b>serial-released</b>
The reproduction, distribution and utilization of this document as well as the communication of its contents to others without express authorization is prohibited. Offenders will be held liable for the payment of damages. All rights reserved in the event of the grant of a patent, utility model or design. Observe copyright by ISO 16016				release date: <b>17.04.2024</b>	sheet: <b>1/1</b>

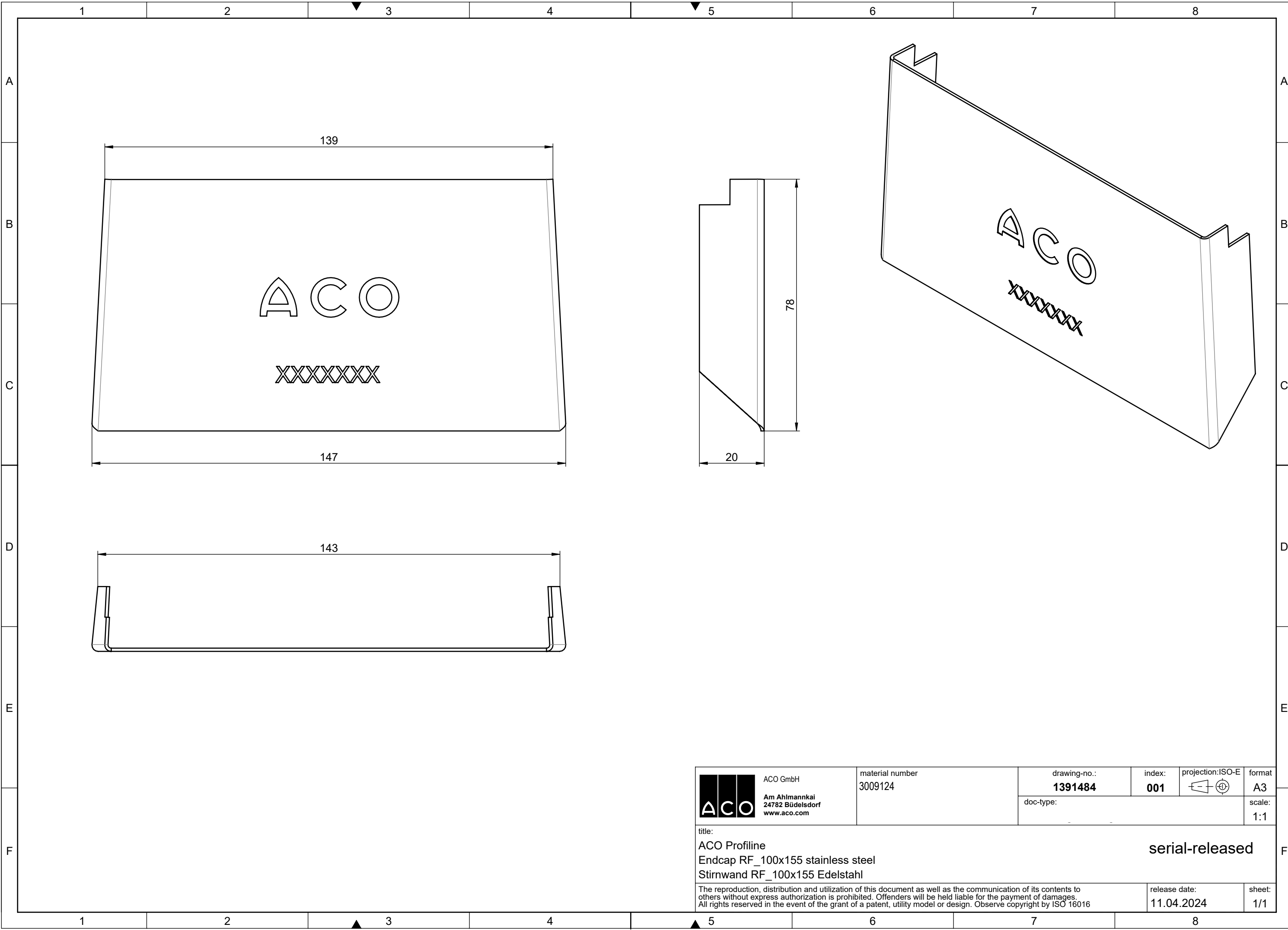

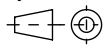
 ACO GmbH Am Ahlmannkai 24782 Büdelsdorf www.aco.com	material number 3009124	drawing-no.: <b>1391484</b>	index: <b>001</b>	projection: ISO-E 	format <b>A3</b>
	doc-type:				scale: <b>1:1</b>
title: <b>ACO Proffline</b> <b>Endcap RF_100x155 stainless steel</b> <b>Stirnwand RF_100x155 Edelstahl</b>					<b>serial-released</b>
<small>The reproduction, distribution and utilization of this document as well as the communication of its contents to others without express authorization is prohibited. Offenders will be held liable for the payment of damages. All rights reserved in the event of the grant of a patent, utility model or design. Observe copyright by ISO 16016</small>				release date: <b>11.04.2024</b>	sheet: <b>1/1</b>

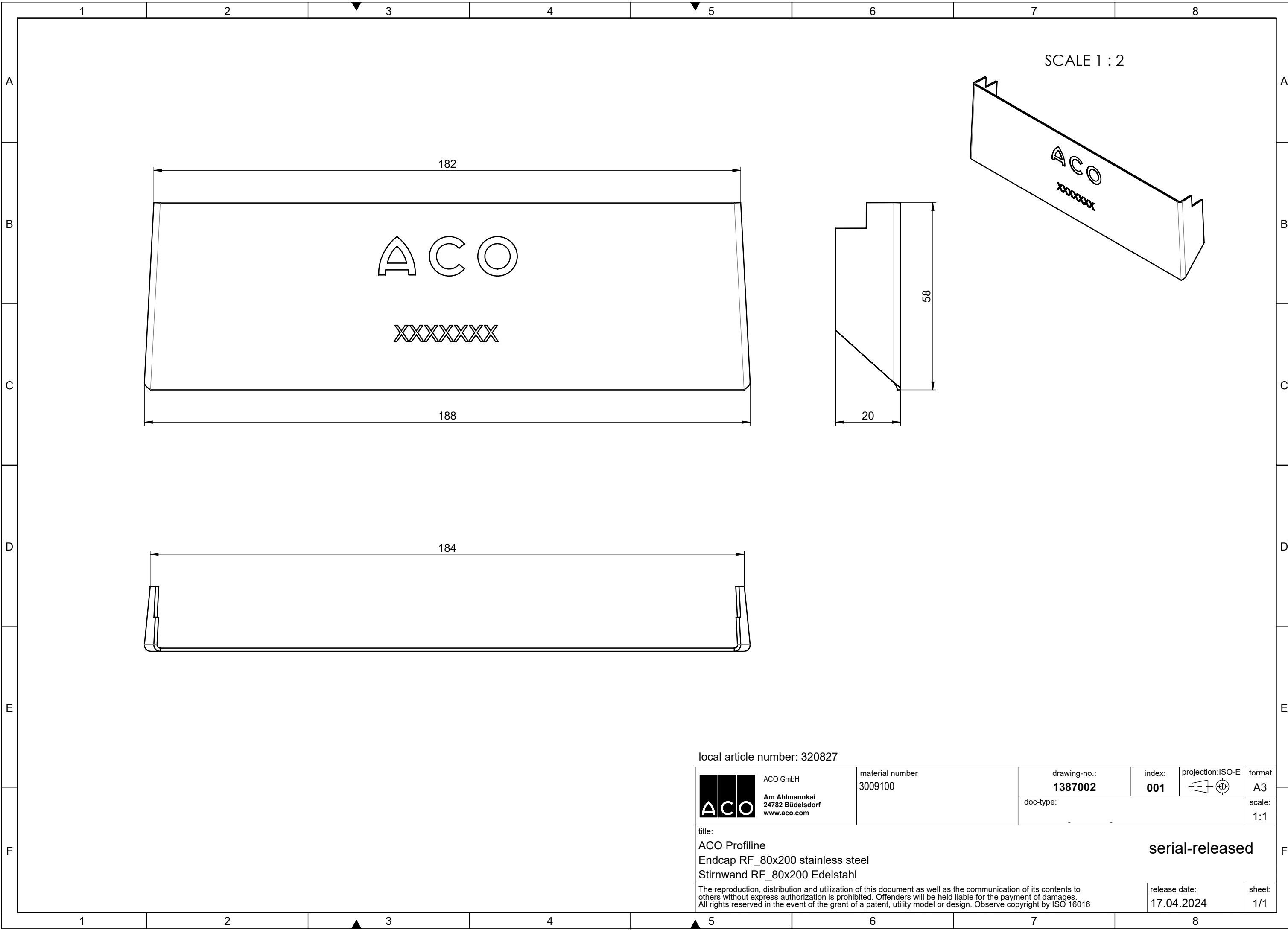

SCALE 1 : 2

ACO

XXXXXXXX

58

20

182



188

184

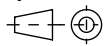
local article number: 320827

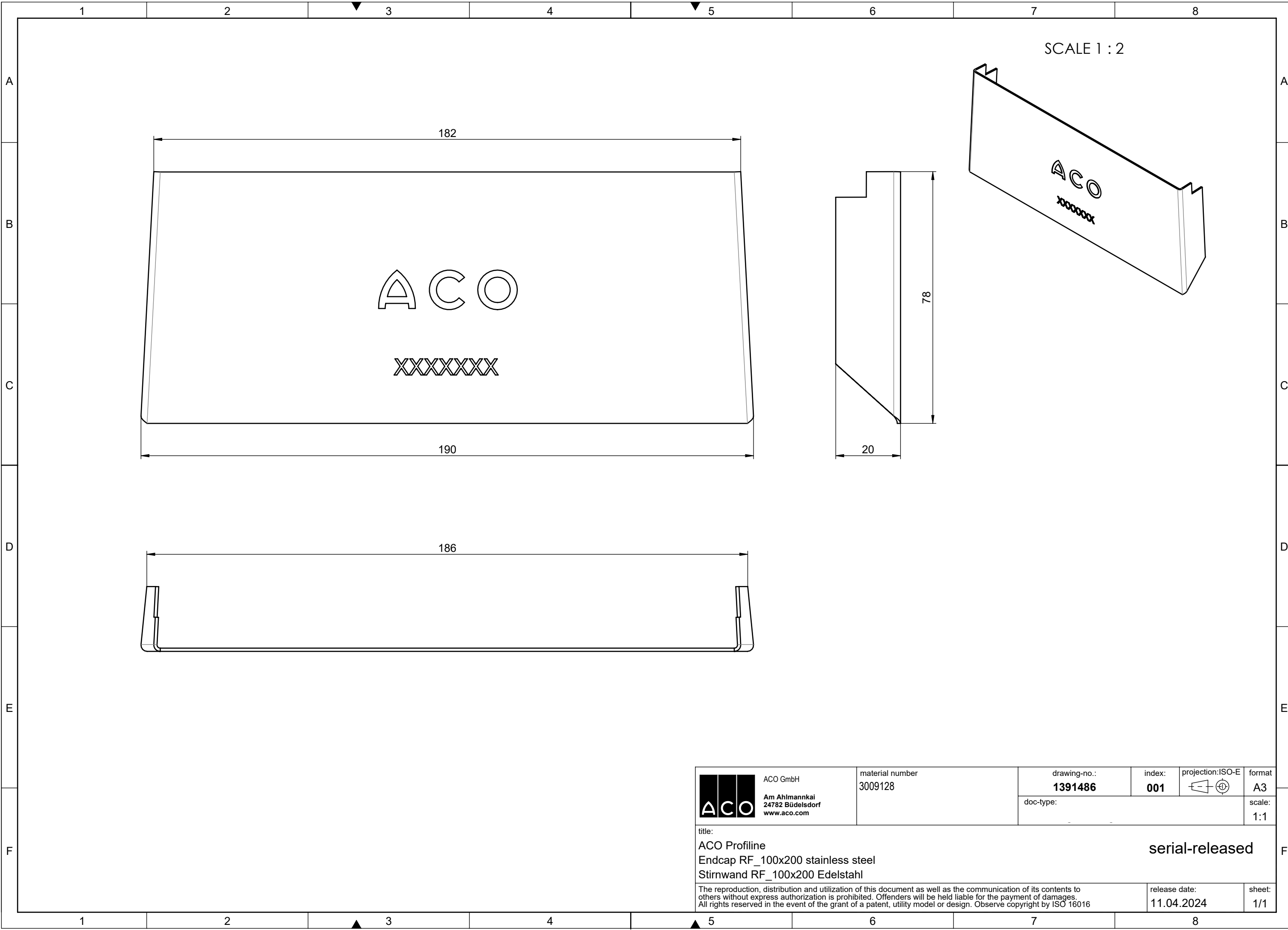
 ACO GmbH Am Ahlmannkai 24782 Büdelsdorf www.aco.com	material number 3009100	drawing-no.: <b>1387002</b>	index: <b>001</b>	projection: ISO-E 	format <b>A3</b>
		doc-type:			scale: <b>1:1</b>
title: ACO Proffline Endcap RF_80x200 stainless steel Stirnwand RF_80x200 Edelstahl					serial-released
<small>The reproduction, distribution and utilization of this document as well as the communication of its contents to others without express authorization is prohibited. Offenders will be held liable for the payment of damages. All rights reserved in the event of the grant of a patent, utility model or design. Observe copyright by ISO 16016</small>				release date: <b>17.04.2024</b>	sheet: <b>1/1</b>



 ACO GmbH Am Ahlmannkai 24782 Büdelsdorf www.aco.com	material number 3009128	drawing-no.: <b>1391486</b>	index: <b>001</b>	projection: ISO-E 	format <b>A3</b>
	doc-type:				scale: <b>1:1</b>
title: ACO Proffline Endcap RF_100x200 stainless steel Stirnwand RF_100x200 Edelstahl					<b>serial-released</b>
<small>The reproduction, distribution and utilization of this document as well as the communication of its contents to others without express authorization is prohibited. Offenders will be held liable for the payment of damages. All rights reserved in the event of the grant of a patent, utility model or design. Observe copyright by ISO 16016</small>				release date: <b>11.04.2024</b>	sheet: <b>1/1</b>

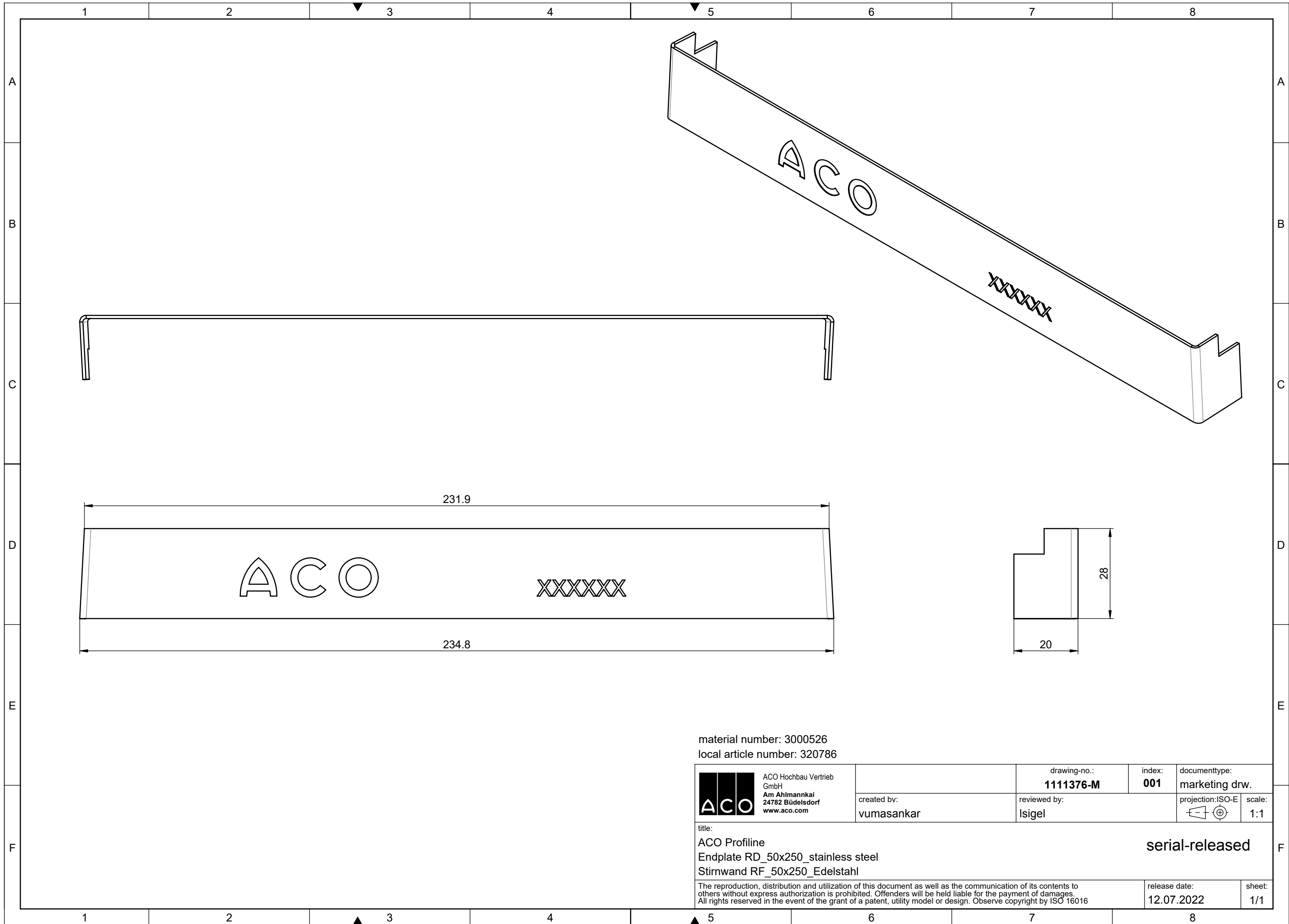

material number: 3000526  
 local article number: 320786

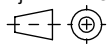
 ACO Hochbau Vertrieb GmbH Am Ahlmannkai 24782 Büdelsdorf www.aco.com	drawing-no.: <b>1111376-M</b>	index: <b>001</b>	documenttype: <b>marketing drw.</b>
	created by: <b>vumasankar</b>	reviewed by: <b>Isigel</b>	projection: ISO-E 
title: <b>ACO Profiline          Endplate RD_50x250_stainless steel          Stirnwand RF_50x250_Edelstahl</b>			<b>serial-released</b>
<small>The reproduction, distribution and utilization of this document as well as the communication of its contents to others without express authorization is prohibited. Offenders will be held liable for the payment of damages. All rights reserved in the event of the grant of a patent, utility model or design. Observe copyright by ISO 16016</small>			release date: <b>12.07.2022</b>
			sheet: <b>1/1</b>

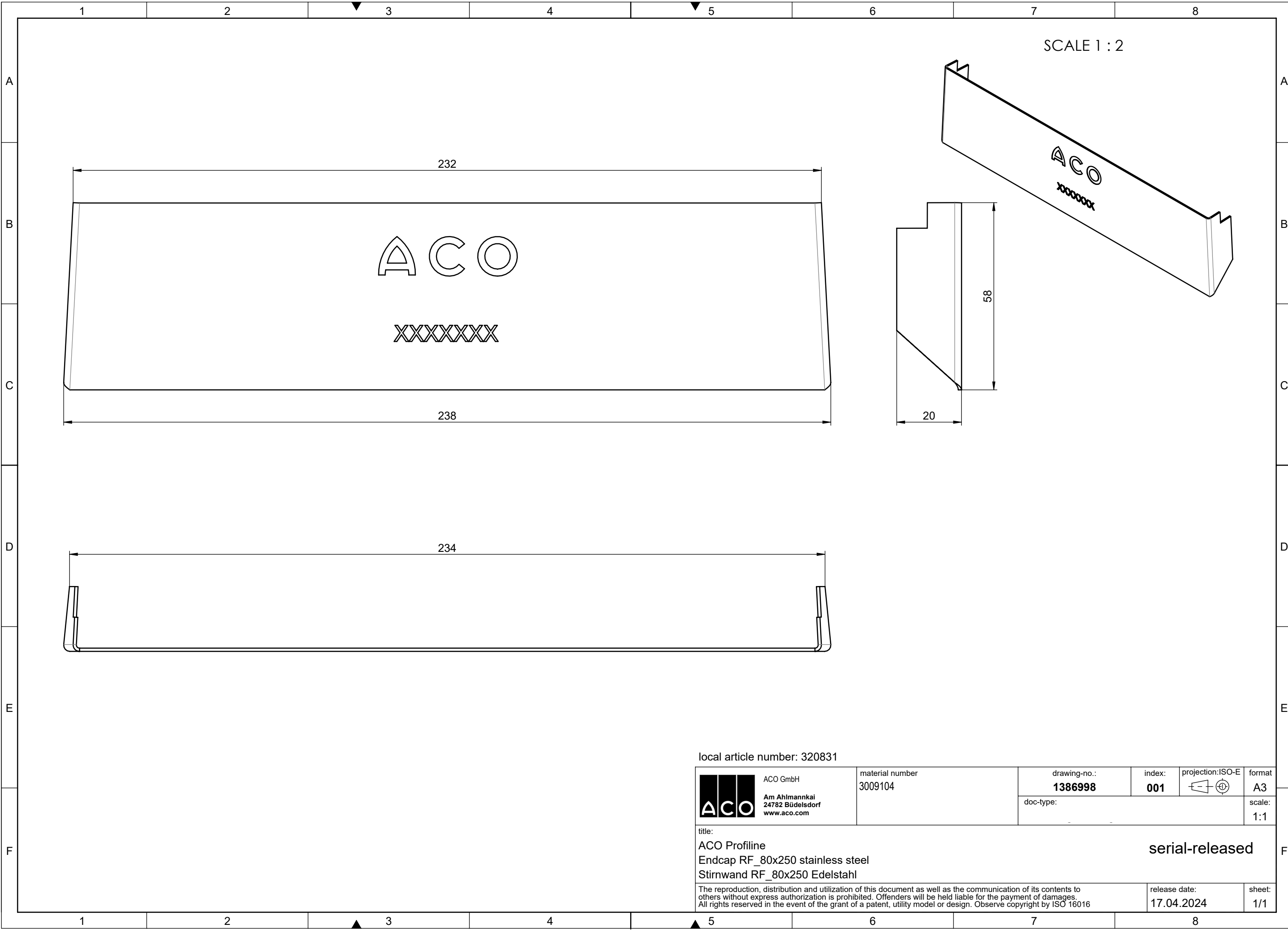

SCALE 1 : 2

ACO



XXXXXXXXXX

ACO  
XXXXXXXXXX

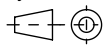
local article number: 320831

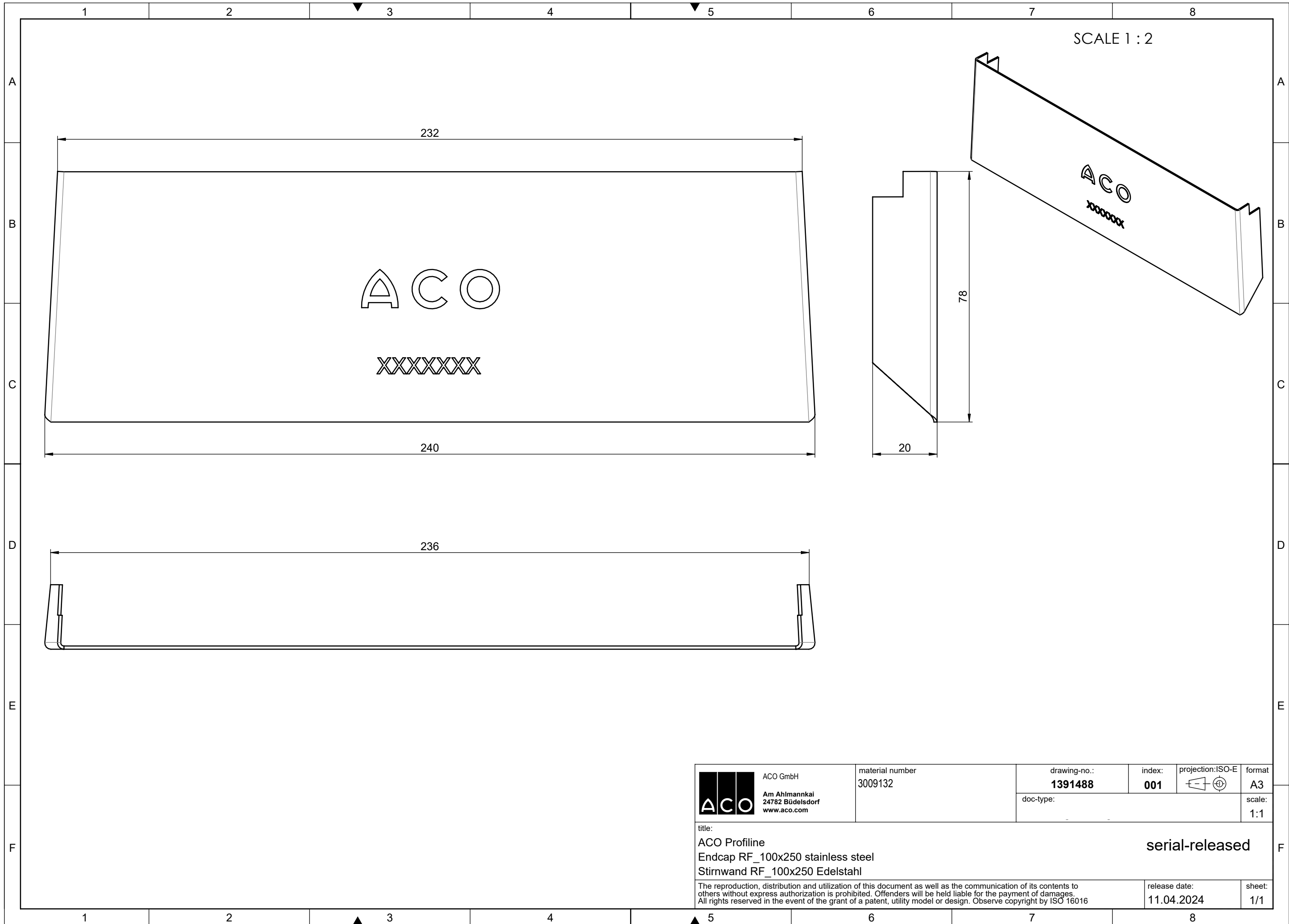
 ACO GmbH Am Ahlmannkai 24782 Büdelsdorf www.aco.com	material number 3009104	drawing-no.: <b>1386998</b>	index: <b>001</b>	projection: ISO-E 	format <b>A3</b>
		doc-type:			scale: <b>1:1</b>
title: ACO Profiline Endcap RF_80x250 stainless steel Stirnwand RF_80x250 Edelstahl					serial-released
<small>The reproduction, distribution and utilization of this document as well as the communication of its contents to others without express authorization is prohibited. Offenders will be held liable for the payment of damages. All rights reserved in the event of the grant of a patent, utility model or design. Observe copyright by ISO 16016</small>				release date: <b>17.04.2024</b>	sheet: <b>1/1</b>



 ACO GmbH Am Ahlmannkai 24782 Büdelsdorf www.aco.com	material number 3009132	drawing-no.: <b>1391488</b>	index: <b>001</b>	projection: ISO-E 	format A3
	doc-type:				scale: 1:1
title: ACO Profiline Endcap RF_100x250 stainless steel Stirnwand RF_100x250 Edelstahl					serial-released
The reproduction, distribution and utilization of this document as well as the communication of its contents to others without express authorization is prohibited. Offenders will be held liable for the payment of damages. All rights reserved in the event of the grant of a patent, utility model or design. Observe copyright by ISO 16016				release date: 11.04.2024	sheet: 1/1



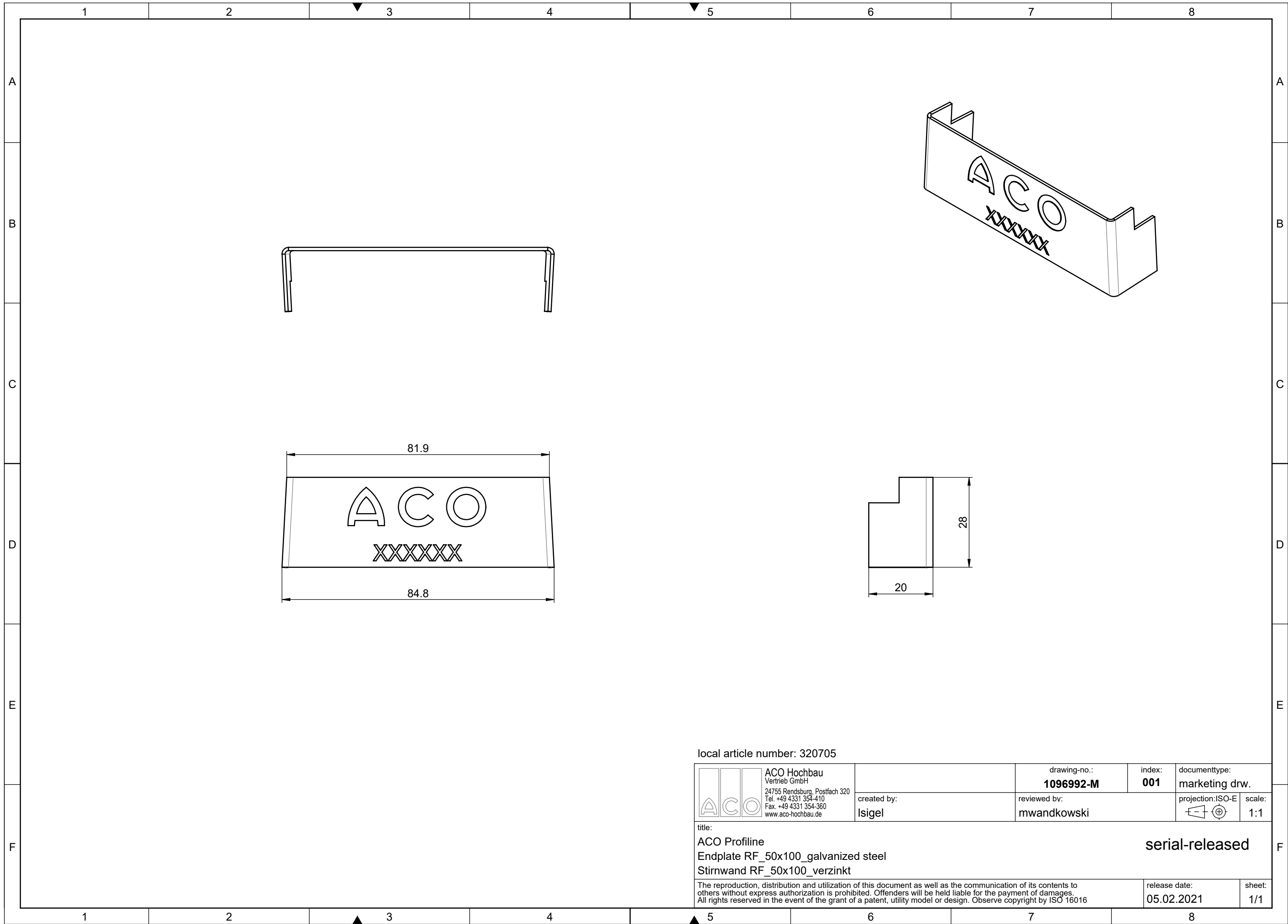

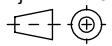

local article number: 320705

 ACO Hochbau Vertrieb GmbH 24755 Rendsburg, Postfach 320 Tel. +49 4331 354-410 Fax. +49 4331 354-360 www.aco-hochbau.de	drawing-no.: <b>1096992-M</b>	index: <b>001</b>	documenttype: <b>marketing drw.</b>
	created by: <b>Isigel</b>	reviewed by: <b>mwandkowski</b>	projection: ISO-E 
title: <b>ACO Profiline          Endplate RF_50x100_galvanized steel          Stirnwand RF_50x100_verzinkt</b>			<b>serial-released</b>
<small>The reproduction, distribution and utilization of this document as well as the communication of its contents to others without express authorization is prohibited. Offenders will be held liable for the payment of damages. All rights reserved in the event of the grant of a patent, utility model or design. Observe copyright by ISO 16016</small>			release date: <b>05.02.2021</b>
			sheet: <b>1/1</b>

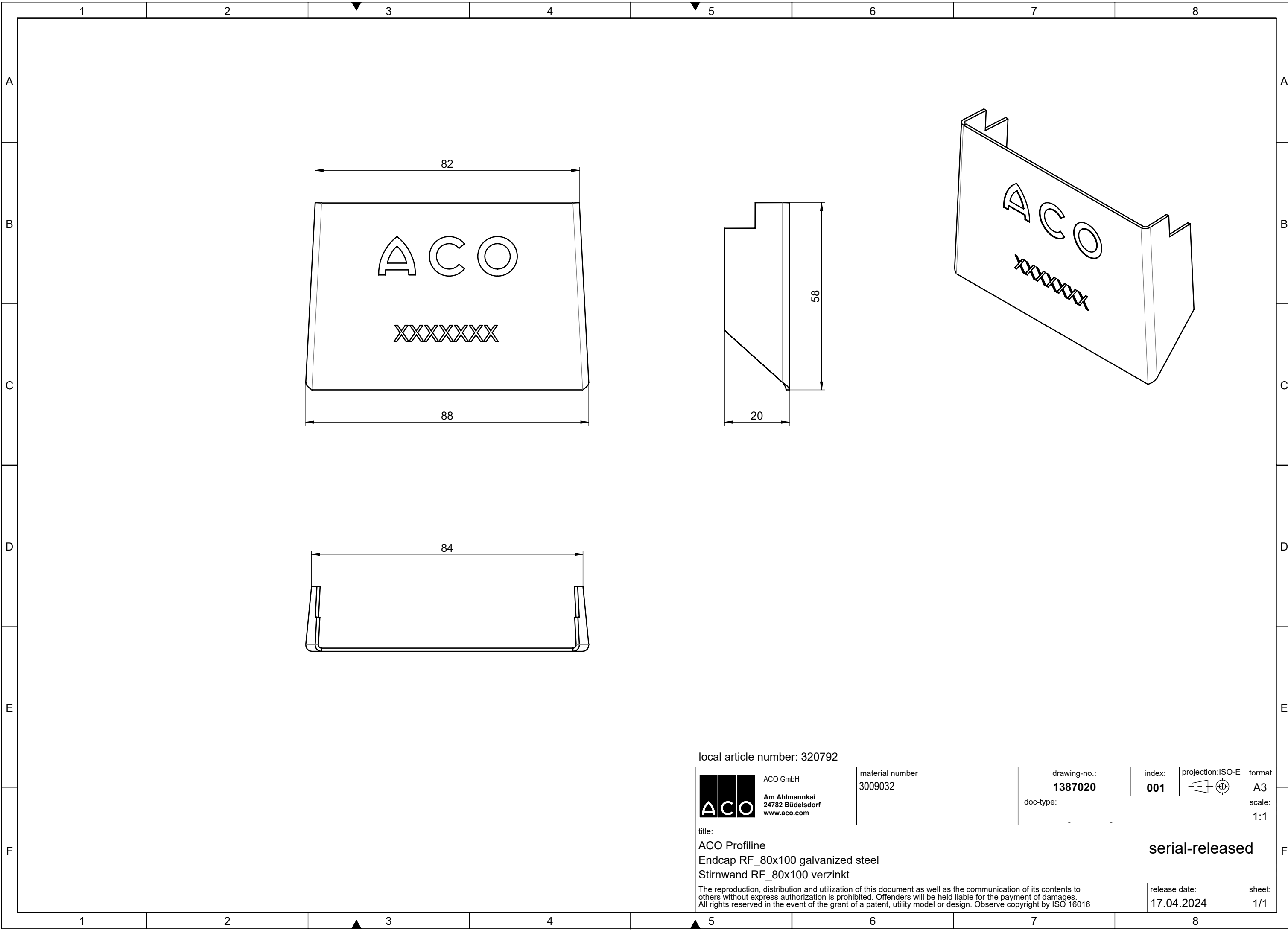
S:\projekte\2019\001\_A3\_Vertrieb\Z1



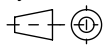

local article number: 320792

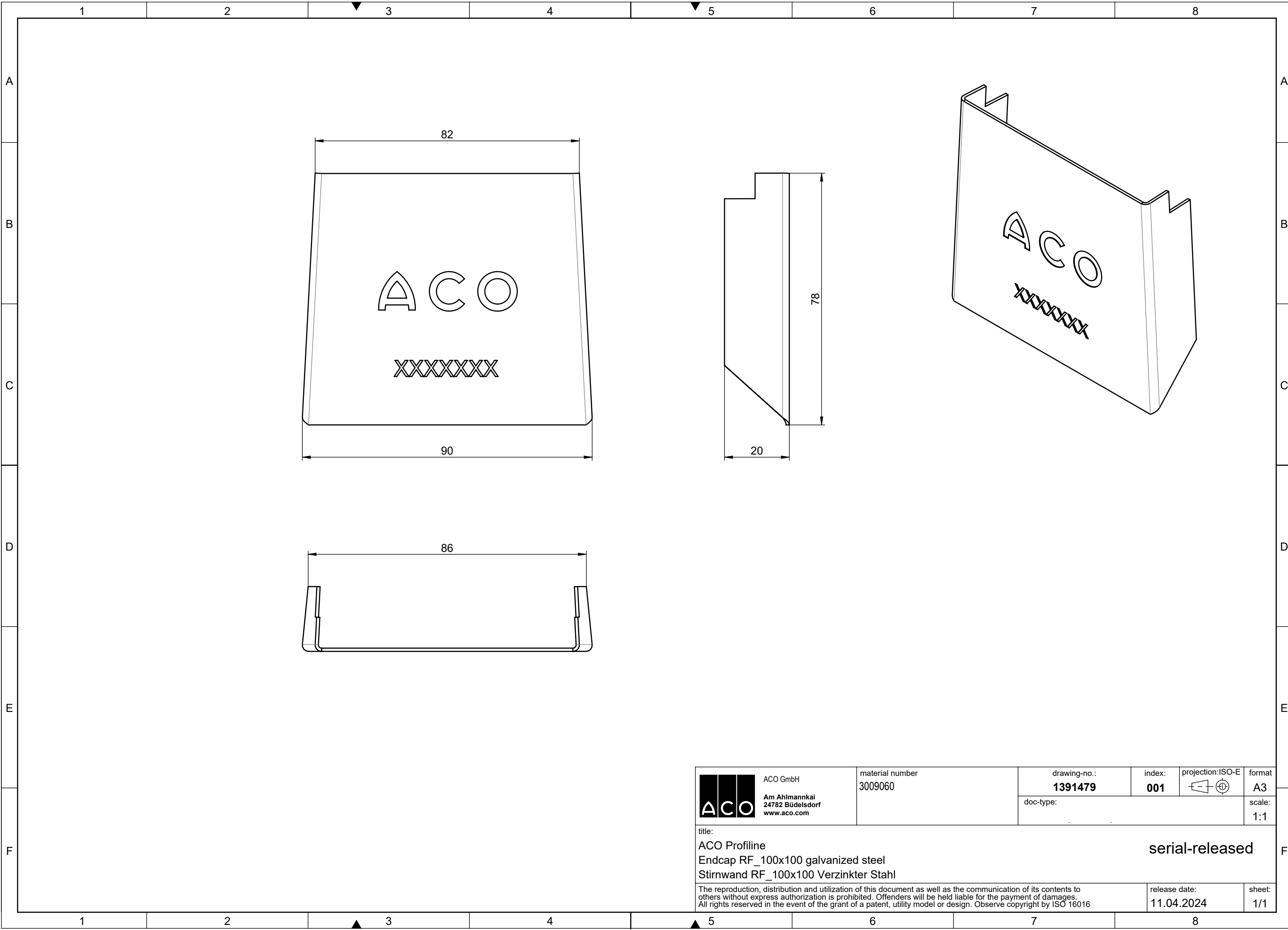
 ACO GmbH Am Ahlmannkai 24782 Büdelsdorf www.aco.com	material number 3009032	drawing-no.: <b>1387020</b>	index: <b>001</b>	projection: ISO-E 	format A3
	doc-type:				scale: 1:1
title: ACO Profiline Endcap RF_80x100 galvanized steel Stirnwand RF_80x100 verzinkt					serial-released
The reproduction, distribution and utilization of this document as well as the communication of its contents to others without express authorization is prohibited. Offenders will be held liable for the payment of damages. All rights reserved in the event of the grant of a patent, utility model or design. Observe copyright by ISO 16016			release date: 17.04.2024	sheet: 1/1	

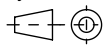

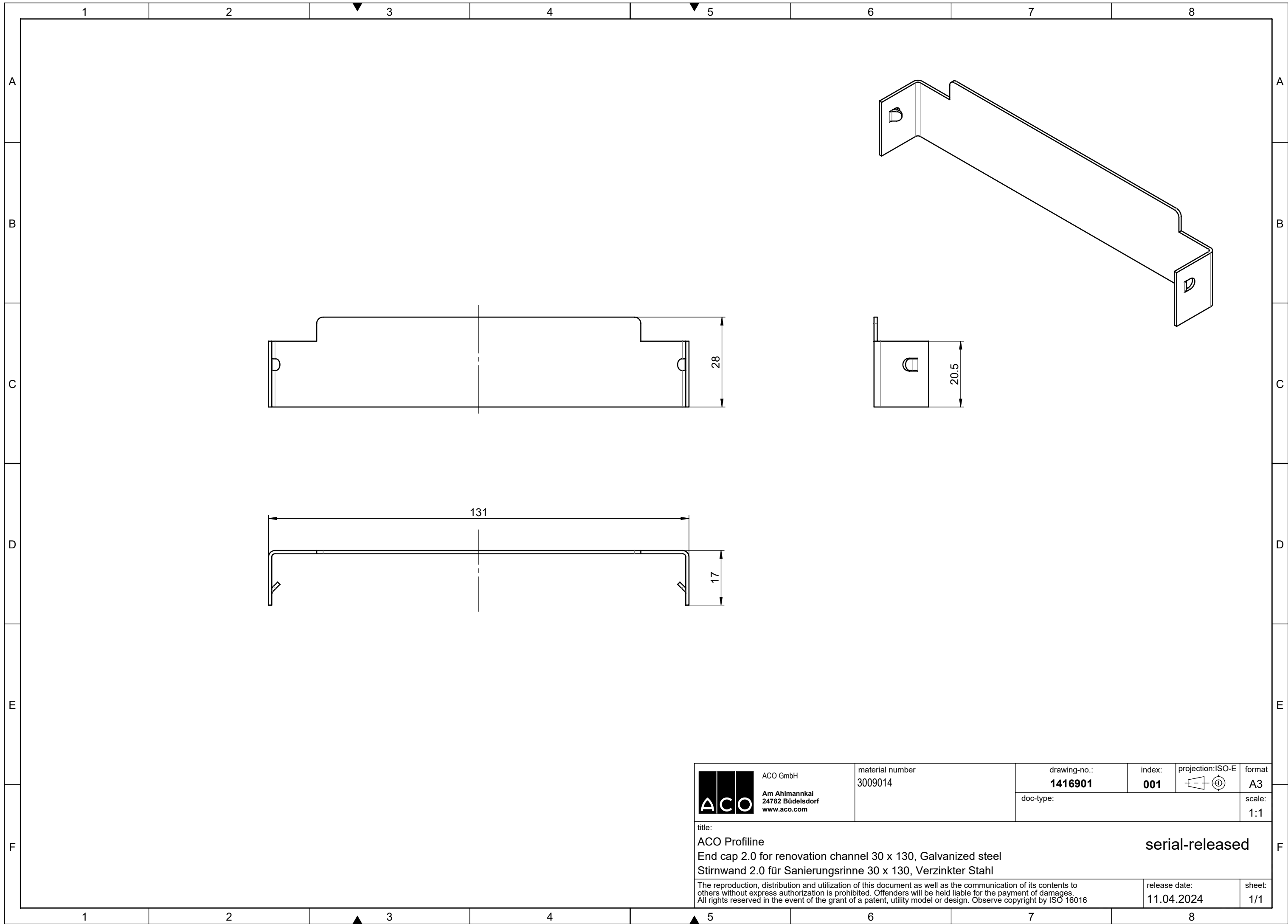
 ACO GmbH Am Ahlmannkai 24782 Büdelsdorf www.aco.com	material number 3009060	drawing-no.: <b>1391479</b>	index: <b>001</b>	projection: ISO-E 	format A3
	doc-type:				scale: 1:1
title: ACO Proffline Endcap RF_100x100 galvanized steel Stirnwand RF_100x100 Verzinkter Stahl					serial-released
The reproduction, distribution and utilization of this document as well as the communication of its contents to others without express authorization is prohibited. Offenders will be held liable for the payment of damages. All rights reserved in the event of the grant of a patent, utility model or design. Observe copyright by ISO 16016				release date: 11.04.2024	sheet: 1/1

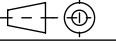

 <b>ACO</b> GmbH Am Ahlmannkai 24782 Büdelsdorf www.aco.com	material number 3009014	drawing-no.: <b>1416901</b>	index: <b>001</b>	projection: ISO-E 	format <b>A3</b>
	doc-type:				scale: <b>1:1</b>
title: <b>ACO Proffline</b> <b>End cap 2.0 for renovation channel 30 x 130, Galvanized steel</b> <b>Stirnwand 2.0 für Sanierungsrinne 30 x 130, Verzinkter Stahl</b>					<b>serial-released</b>
The reproduction, distribution and utilization of this document as well as the communication of its contents to others without express authorization is prohibited. Offenders will be held liable for the payment of damages. All rights reserved in the event of the grant of a patent, utility model or design. Observe copyright by ISO 16016				release date: <b>11.04.2024</b>	sheet: <b>1/1</b>

DWG 1416901

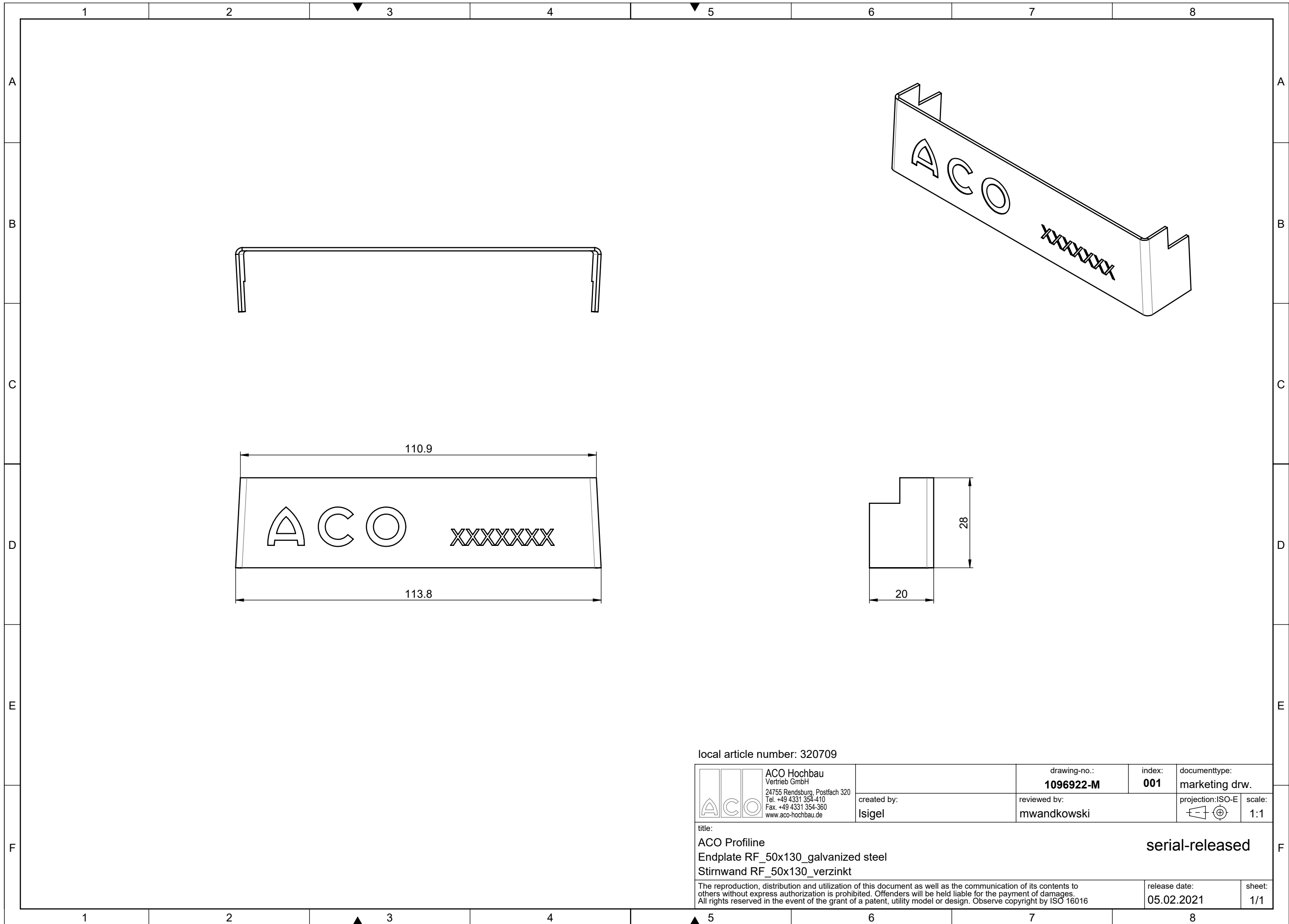

local article number: 320709

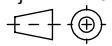
 ACO Hochbau Vertrieb GmbH 24755 Rendsburg, Postfach 320 Tel. +49 4331 354-410 Fax. +49 4331 354-360 www.aco-hochbau.de	drawing-no.: <b>1096922-M</b>	index: <b>001</b>	documenttype: <b>marketing drw.</b>
	created by: <b>Isigel</b>	reviewed by: <b>mwandkowski</b>	projection: ISO-E 
title: <b>ACO Profiline          Endplate RF_50x130_galvanized steel          Stirnwand RF_50x130_verzinkt</b>			<b>serial-released</b>
<small>The reproduction, distribution and utilization of this document as well as the communication of its contents to others without express authorization is prohibited. Offenders will be held liable for the payment of damages. All rights reserved in the event of the grant of a patent, utility model or design. Observe copyright by ISO 16016</small>			release date: <b>05.02.2021</b>
			sheet: <b>1/1</b>

S:\projekte\2019\001\_A3\_Vertrieb\Z1

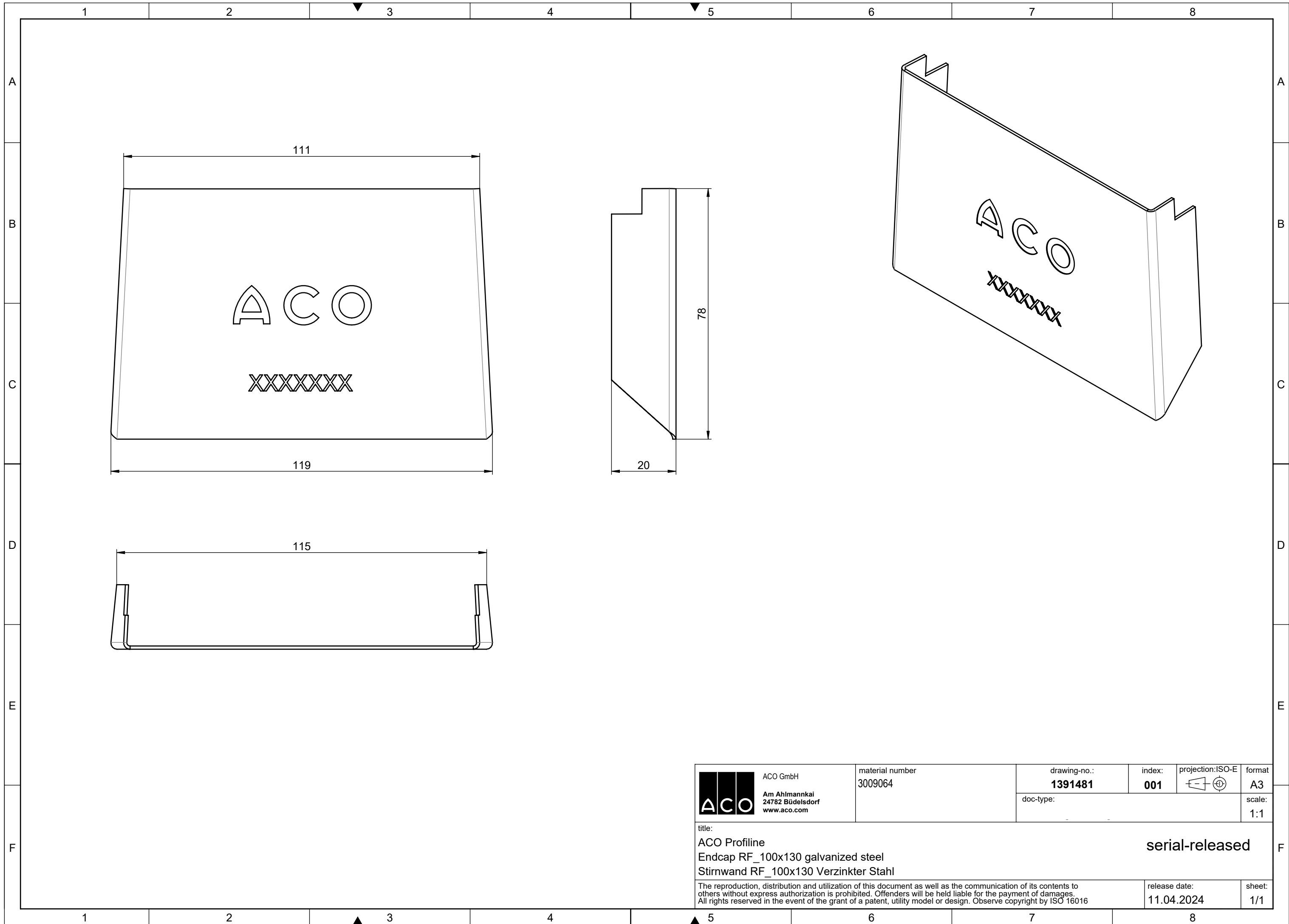

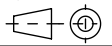
 ACO GmbH Am Ahlmannkai 24782 Büdelsdorf www.aco.com	material number 3009064	drawing-no.: <b>1391481</b>	index: <b>001</b>	projection: ISO-E 	format <b>A3</b>
	doc-type:				scale: <b>1:1</b>
title: ACO Profiline Endcap RF_100x130 galvanized steel Stirnwand RF_100x130 Verzinkter Stahl					<b>serial-released</b>
The reproduction, distribution and utilization of this document as well as the communication of its contents to others without express authorization is prohibited. Offenders will be held liable for the payment of damages. All rights reserved in the event of the grant of a patent, utility model or design. Observe copyright by ISO 16016				release date: <b>11.04.2024</b>	sheet: <b>1/1</b>

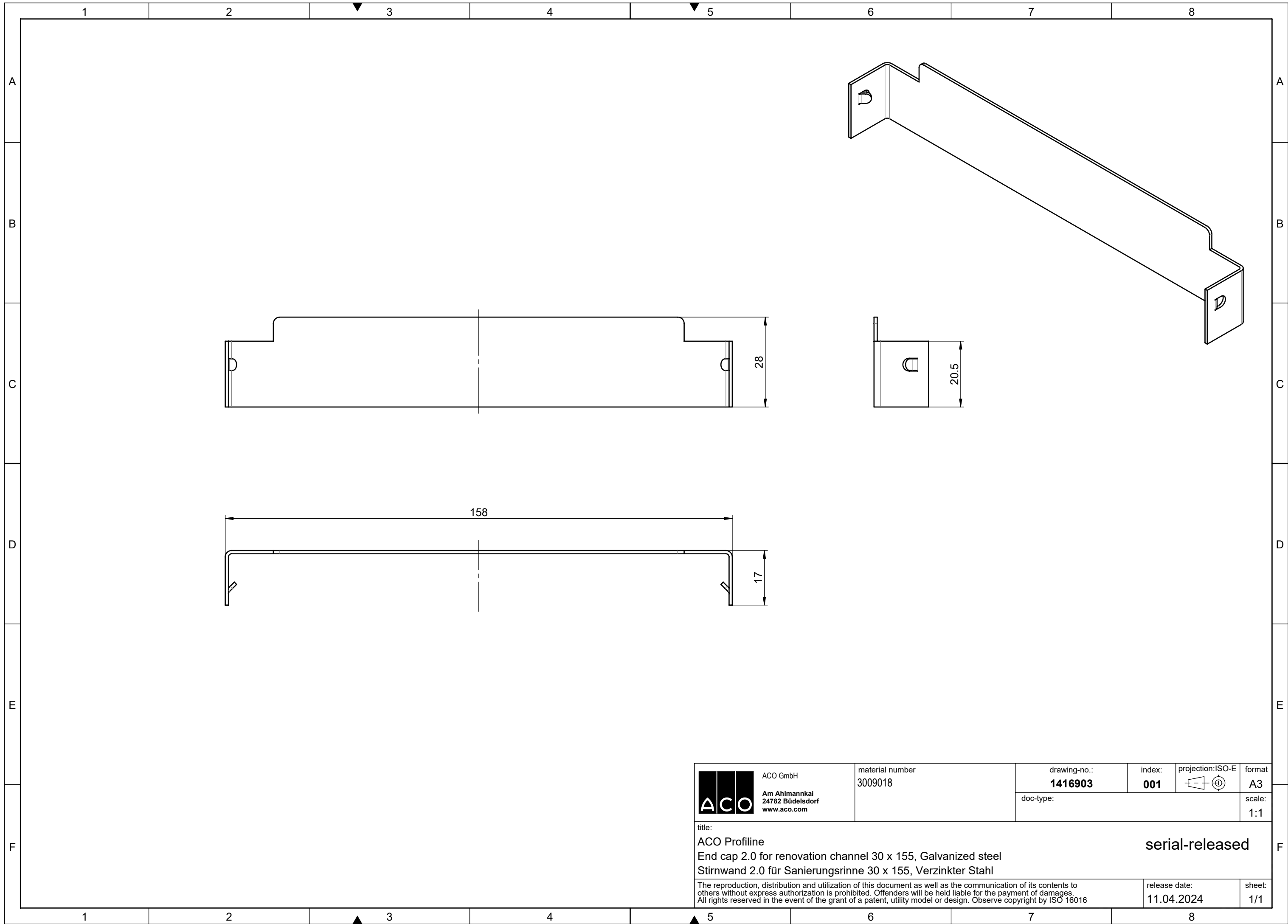

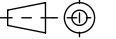
 <b>ACO</b> GmbH Am Ahlmannkai 24782 Büdelsdorf www.aco.com	material number 3009018	drawing-no.: <b>1416903</b>	index: <b>001</b>	projection: ISO-E 	format <b>A3</b>
	doc-type:				scale: <b>1:1</b>
title: <b>ACO Proffline</b> <b>End cap 2.0 for renovation channel 30 x 155, Galvanized steel</b> <b>Stirnwand 2.0 für Sanierungsrinne 30 x 155, Verzinkter Stahl</b>					<b>serial-released</b>
The reproduction, distribution and utilization of this document as well as the communication of its contents to others without express authorization is prohibited. Offenders will be held liable for the payment of damages. All rights reserved in the event of the grant of a patent, utility model or design. Observe copyright by ISO 16016				release date: <b>11.04.2024</b>	sheet: <b>1/1</b>

DWG 1416903

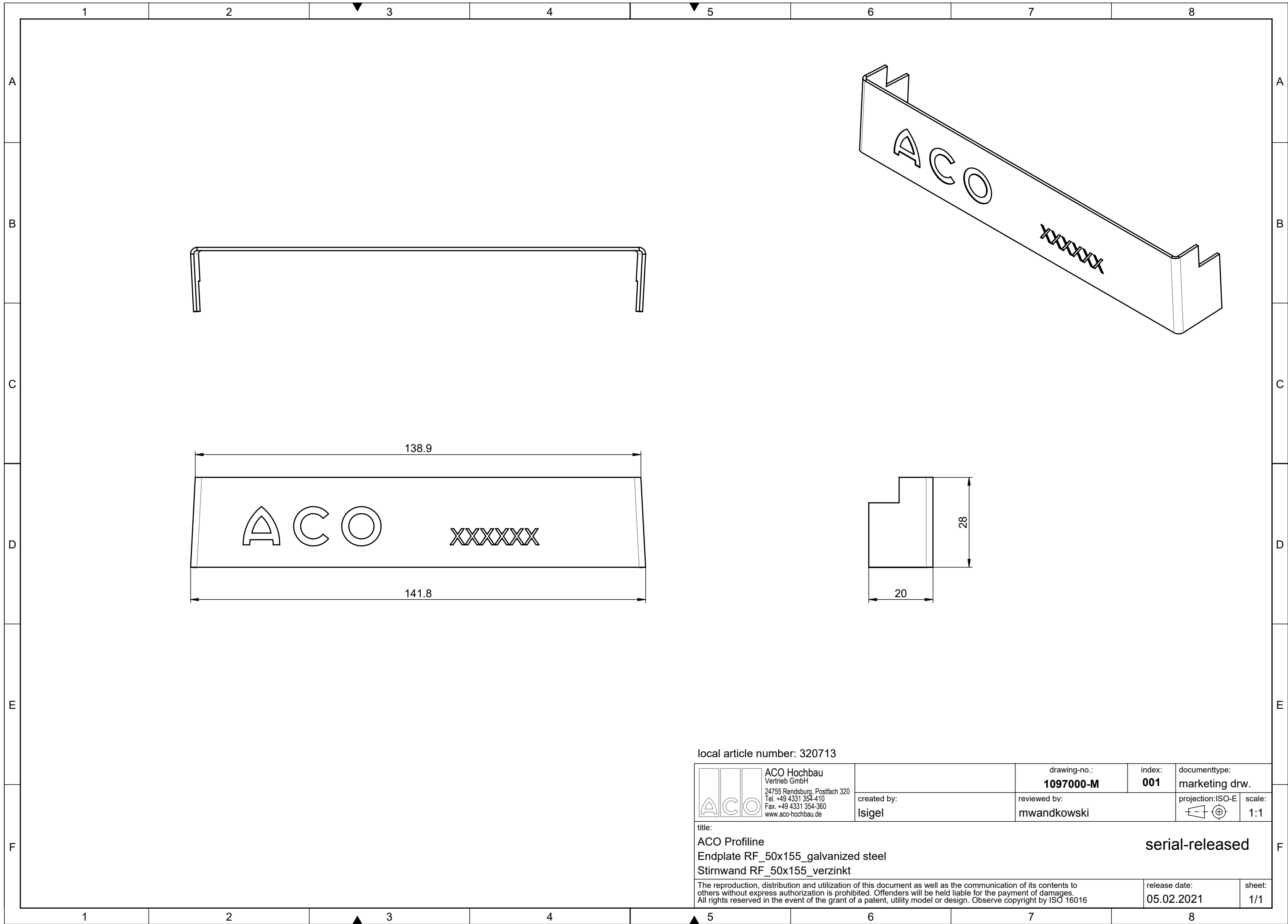

local article number: 320713

**ACO Hochbau**  
 Vertrieb GmbH  
 24755 Rendsburg, Postfach 320  
 Tel. +49 4331 354-410  
 Fax. +49 4331 354-360  
 www.aco-hochbau.de

drawing-no.:  
**1097000-M**  
 created by:  
**Isigel**

index:  
**001**  
 reviewed by:  
**mwandkowski**

documenttype:  
**marketing drw.**  
 projection:ISO-E  

 scale:  
**1:1**

title:  
**ACO Profiline**  
**Endplate RF\_50x155\_galvanized steel**  
**Stirnwand RF\_50x155\_verzinkt**

**serial-released**

The reproduction, distribution and utilization of this document as well as the communication of its contents to others without express authorization is prohibited. Offenders will be held liable for the payment of damages. All rights reserved in the event of the grant of a patent, utility model or design. Observe copyright by ISO 16016

release date:  
**05.02.2021**

sheet:  
**1/1**

S:\projekte\2019\001\_13\_Vertrieb\Z1



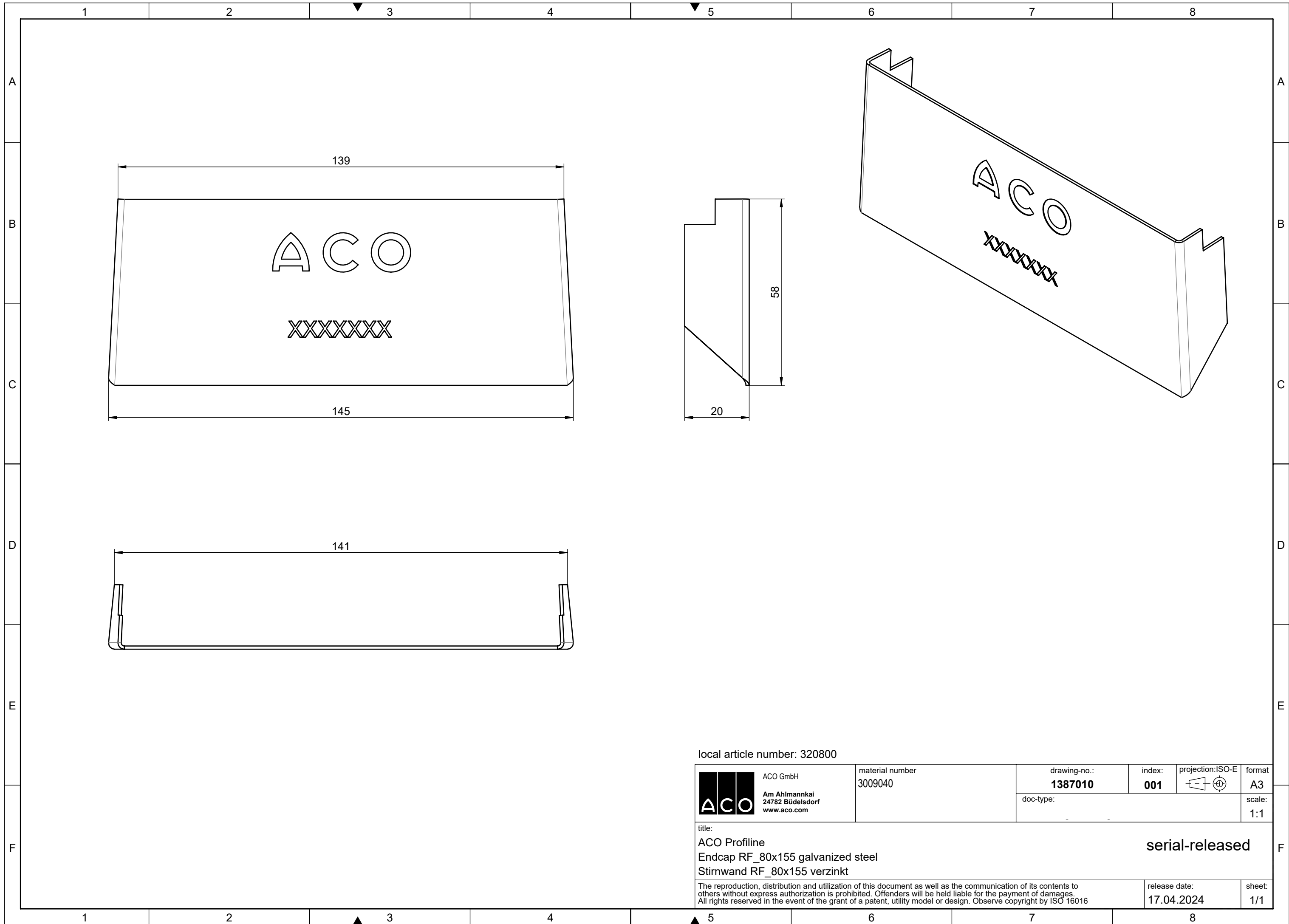

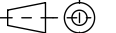

local article number: 320800

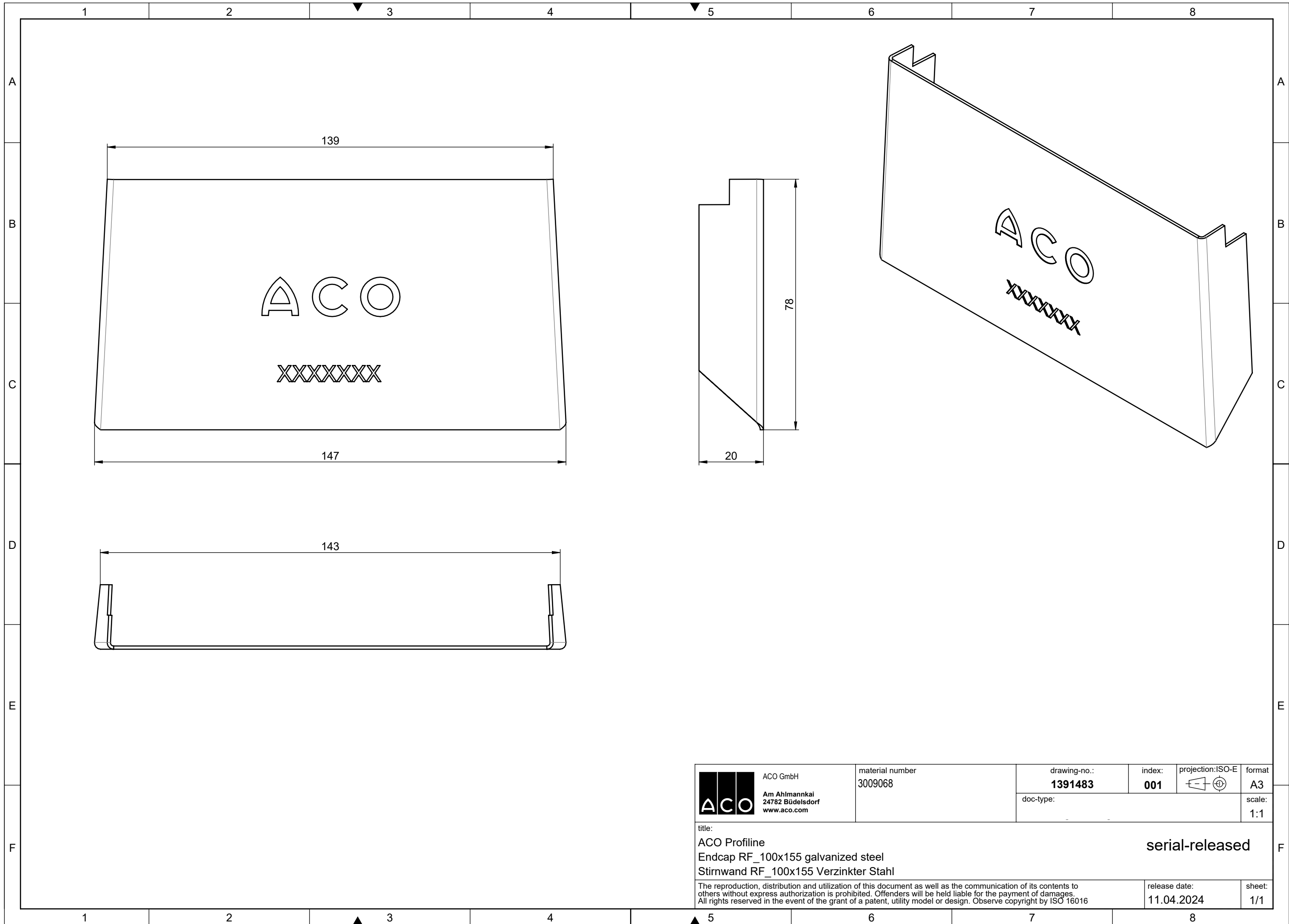
 ACO GmbH Am Ahlmannkai 24782 Büdelsdorf www.aco.com	material number 3009040	drawing-no.: <b>1387010</b>	index: <b>001</b>	projection: ISO-E 	format <b>A3</b>
		doc-type:			scale: <b>1:1</b>
title: <b>ACO Proflin</b> <b>Endcap RF_80x155 galvanized steel</b> <b>Stirnwand RF_80x155 verzinkt</b>					<b>serial-released</b>
<small>The reproduction, distribution and utilization of this document as well as the communication of its contents to others without express authorization is prohibited. Offenders will be held liable for the payment of damages. All rights reserved in the event of the grant of a patent, utility model or design. Observe copyright by ISO 16016</small>				release date: <b>17.04.2024</b>	sheet: <b>1/1</b>



 ACO GmbH Am Ahlmannkai 24782 Büdelsdorf www.aco.com	material number 3009068	drawing-no.: <b>1391483</b>	index: <b>001</b>	projection: ISO-E 	format <b>A3</b>
	doc-type:				scale: <b>1:1</b>
title: <b>ACO Proffline</b> <b>Endcap RF_100x155 galvanized steel</b> <b>Stirnwand RF_100x155 Verzinkter Stahl</b>					<b>serial-released</b>
The reproduction, distribution and utilization of this document as well as the communication of its contents to others without express authorization is prohibited. Offenders will be held liable for the payment of damages. All rights reserved in the event of the grant of a patent, utility model or design. Observe copyright by ISO 16016			release date: <b>11.04.2024</b>	sheet: <b>1/1</b>	

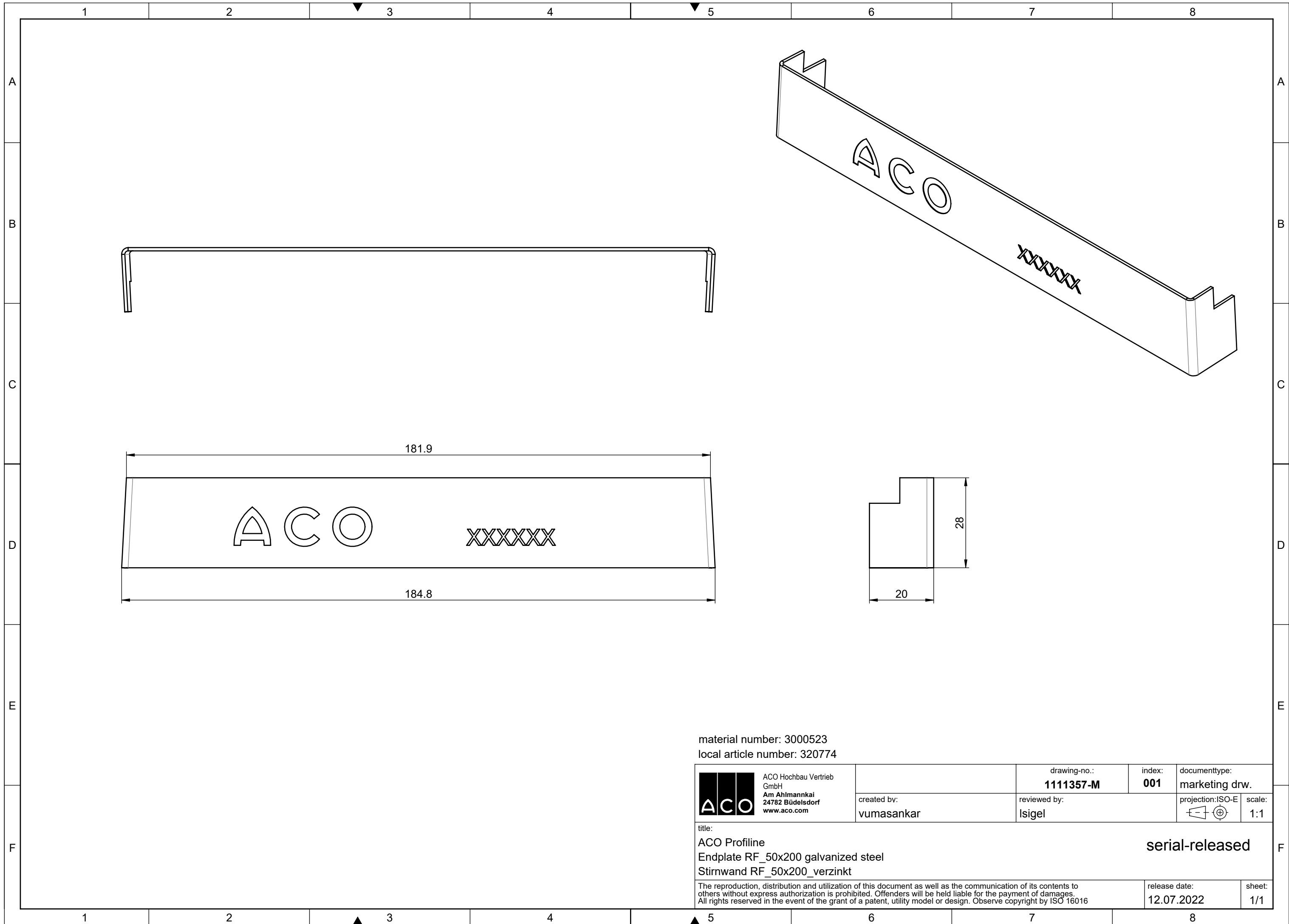

material number: 3000523  
 local article number: 320774

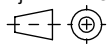
 ACO Hochbau Vertrieb GmbH Am Ahlmannkai 24782 Büdelsdorf www.aco.com	drawing-no.: <b>1111357-M</b>	index: <b>001</b>	documenttype: marketing drw.
	created by: vumasankar	reviewed by: Isigel	projection: ISO-E 
title: ACO Profiline Endplate RF_50x200 galvanized steel Stirnwand RF_50x200_verzinkt			serial-released
<small>The reproduction, distribution and utilization of this document as well as the communication of its contents to others without express authorization is prohibited. Offenders will be held liable for the payment of damages. All rights reserved in the event of the grant of a patent, utility model or design. Observe copyright by ISO 16016</small>			release date: 12.07.2022
			sheet: 1/1

S:\projekte\2019\001\_A3\_Vertrieb\Z1

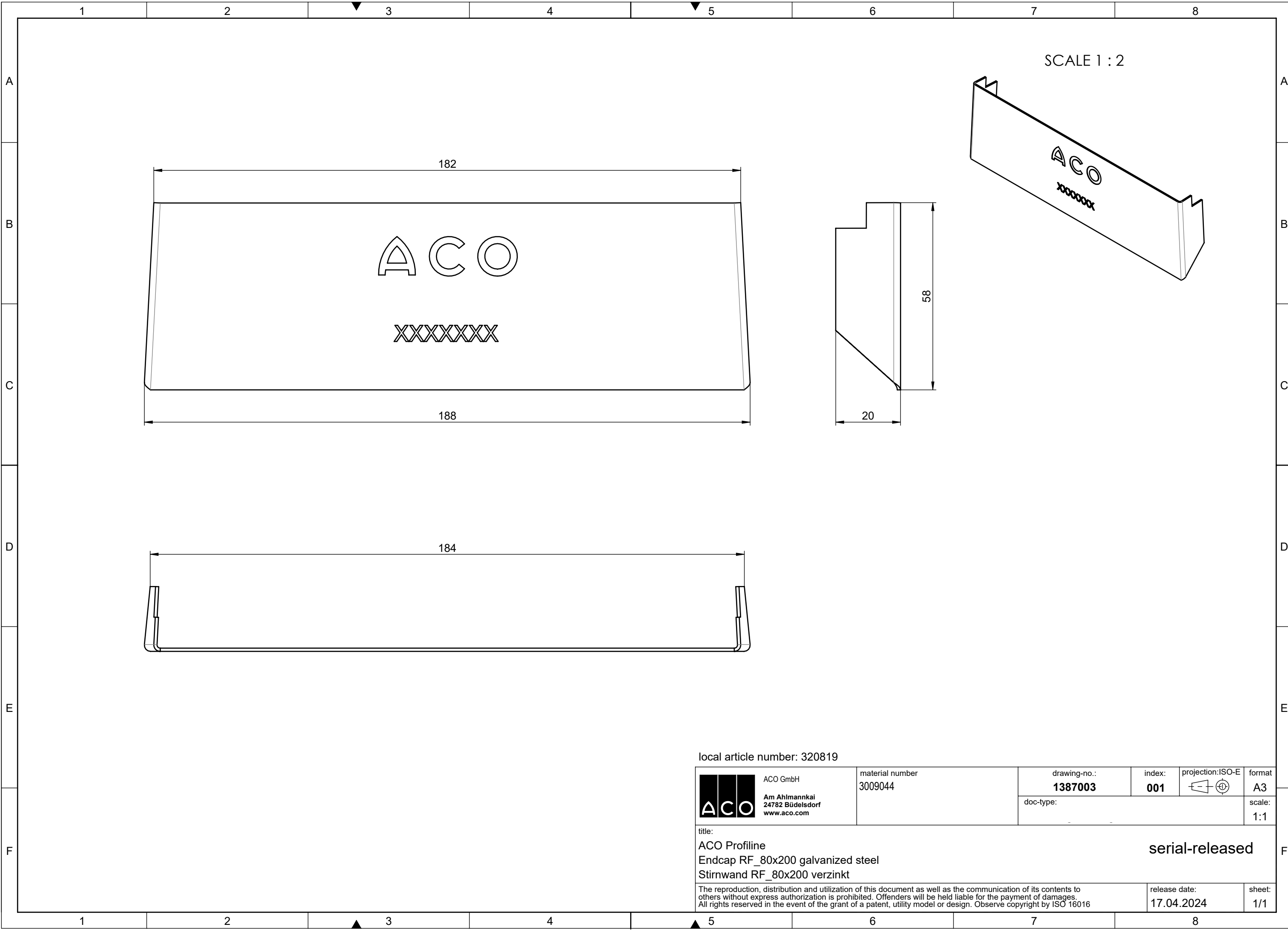

SCALE 1 : 2

ACO

XXXXXXXX

58

20

182

188

184

local article number: 320819

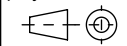
 ACO GmbH Am Ahlmannkai 24782 Büdelsdorf www.aco.com	material number 3009044	drawing-no.: <b>1387003</b>	index: <b>001</b>	projection: ISO-E 	format <b>A3</b>
	doc-type:				scale: <b>1:1</b>
title: ACO Profiline Endcap RF_80x200 galvanized steel Stirnwand RF_80x200 verzinkt					<b>serial-released</b>
The reproduction, distribution and utilization of this document as well as the communication of its contents to others without express authorization is prohibited. Offenders will be held liable for the payment of damages. All rights reserved in the event of the grant of a patent, utility model or design. Observe copyright by ISO 16016				release date: <b>17.04.2024</b>	sheet: <b>1/1</b>

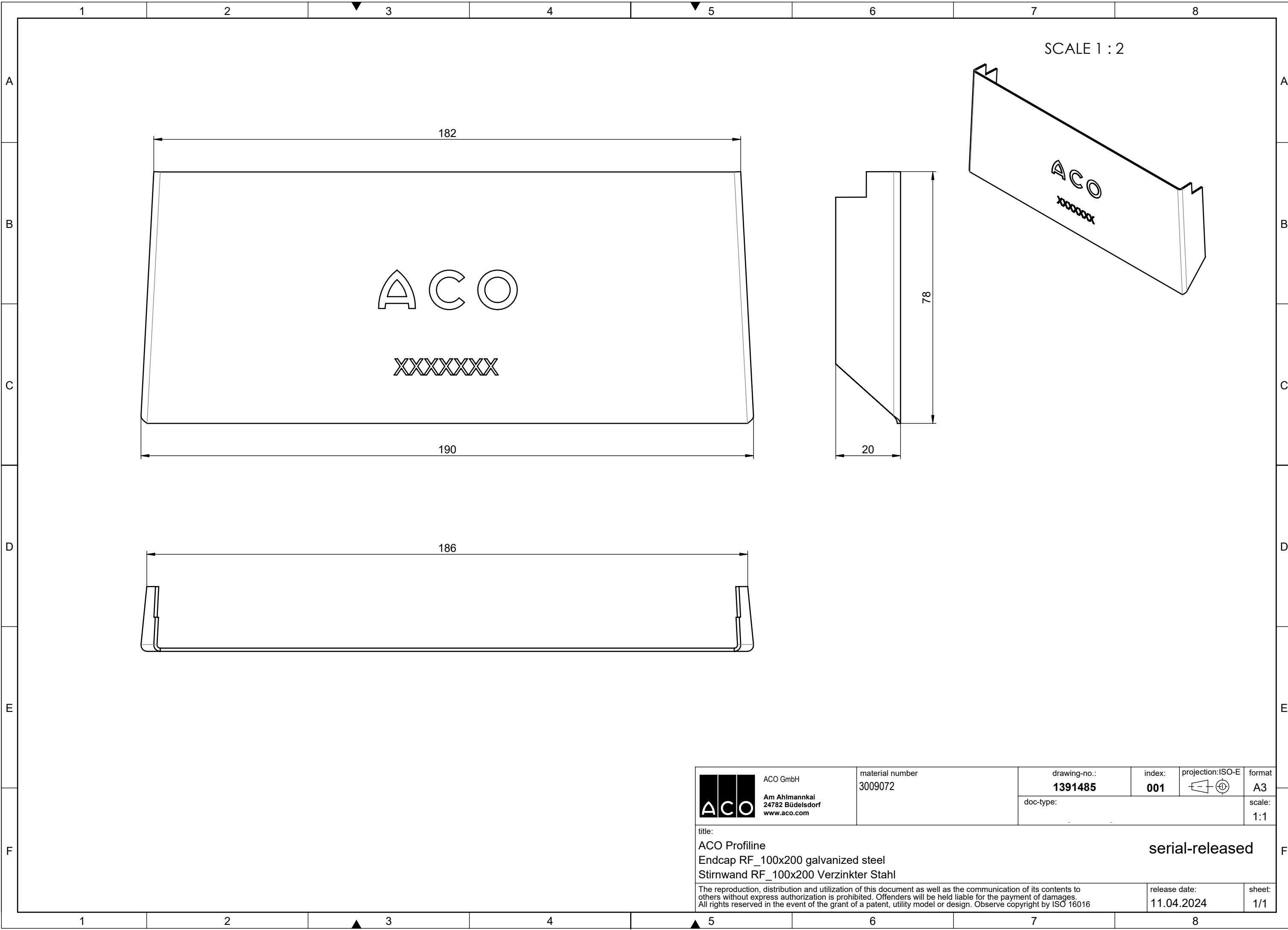

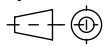
 ACO GmbH Am Ahlmannkai 24782 Büdelsdorf www.aco.com	material number 3009072	drawing-no.: <b>1391485</b>	index: <b>001</b>	projection: ISO-E 	format A3
	doc-type:				scale: 1:1
title: ACO Profiline Endcap RF_100x200 galvanized steel Stirnwand RF_100x200 Verzinkter Stahl					serial-released
The reproduction, distribution and utilization of this document as well as the communication of its contents to others without express authorization is prohibited. Offenders will be held liable for the payment of damages. All rights reserved in the event of the grant of a patent, utility model or design. Observe copyright by ISO 16016				release date: 11.04.2024	sheet: 1/1

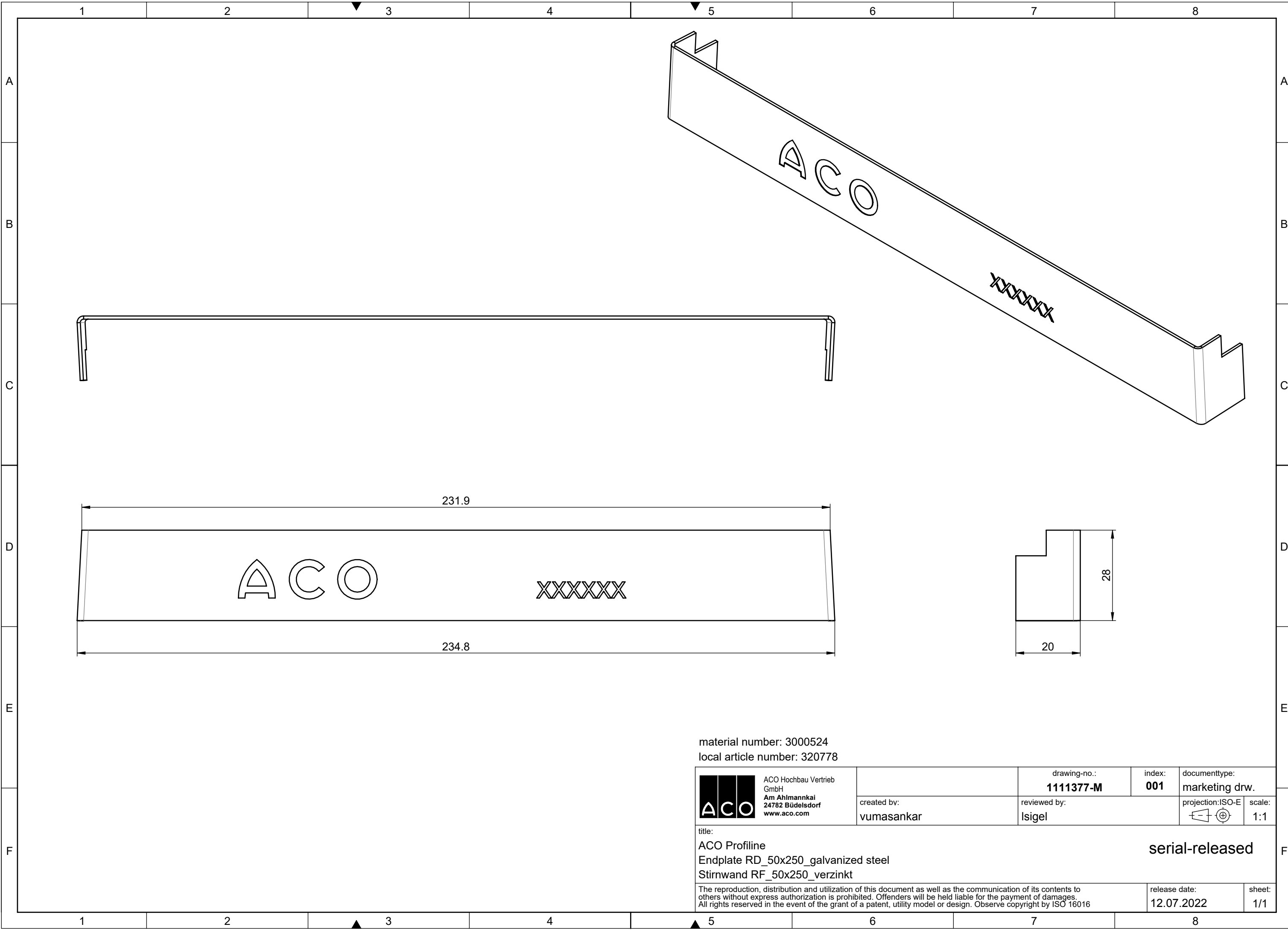

material number: 3000524  
 local article number: 320778

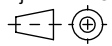
 ACO Hochbau Vertrieb GmbH Am Ahlmannkai 24782 Büdelsdorf www.aco.com	drawing-no.: <b>1111377-M</b>	index: <b>001</b>	documenttype: <b>marketing drw.</b>
	created by: <b>vumasankar</b>	reviewed by: <b>Isigel</b>	projection: ISO-E 
title: <b>ACO Proffline          Endplate RD_50x250_galvanized steel          Stirnwand RF_50x250_verzinkt</b>			<b>serial-released</b>
<small>The reproduction, distribution and utilization of this document as well as the communication of its contents to others without express authorization is prohibited. Offenders will be held liable for the payment of damages. All rights reserved in the event of the grant of a patent, utility model or design. Observe copyright by ISO 16016</small>			release date: <b>12.07.2022</b>
			sheet: <b>1/1</b>

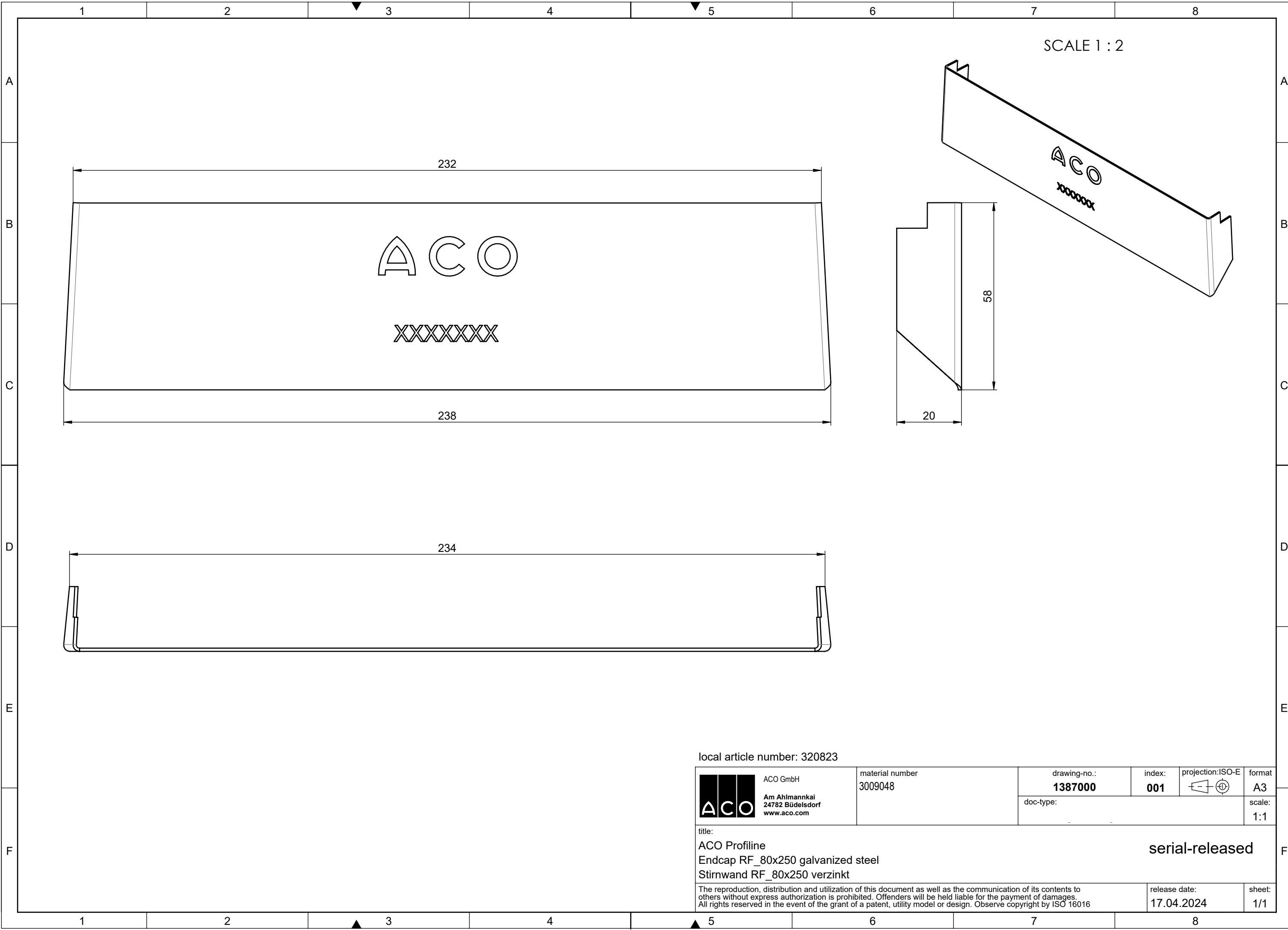

SCALE 1 : 2

ACO

XXXXXXXX

ACO  
XXXXXXXX

local article number: 320823

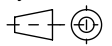
 ACO GmbH Am Ahlmannkai 24782 Büdelsdorf www.aco.com	material number 3009048	drawing-no.: <b>1387000</b>	index: <b>001</b>	projection: ISO-E 	format A3
	doc-type:				scale: 1:1
title: ACO Profiline Endcap RF_80x250 galvanized steel Stirnwand RF_80x250 verzinkt					serial-released
The reproduction, distribution and utilization of this document as well as the communication of its contents to others without express authorization is prohibited. Offenders will be held liable for the payment of damages. All rights reserved in the event of the grant of a patent, utility model or design. Observe copyright by ISO 16016			release date: 17.04.2024	sheet: 1/1	

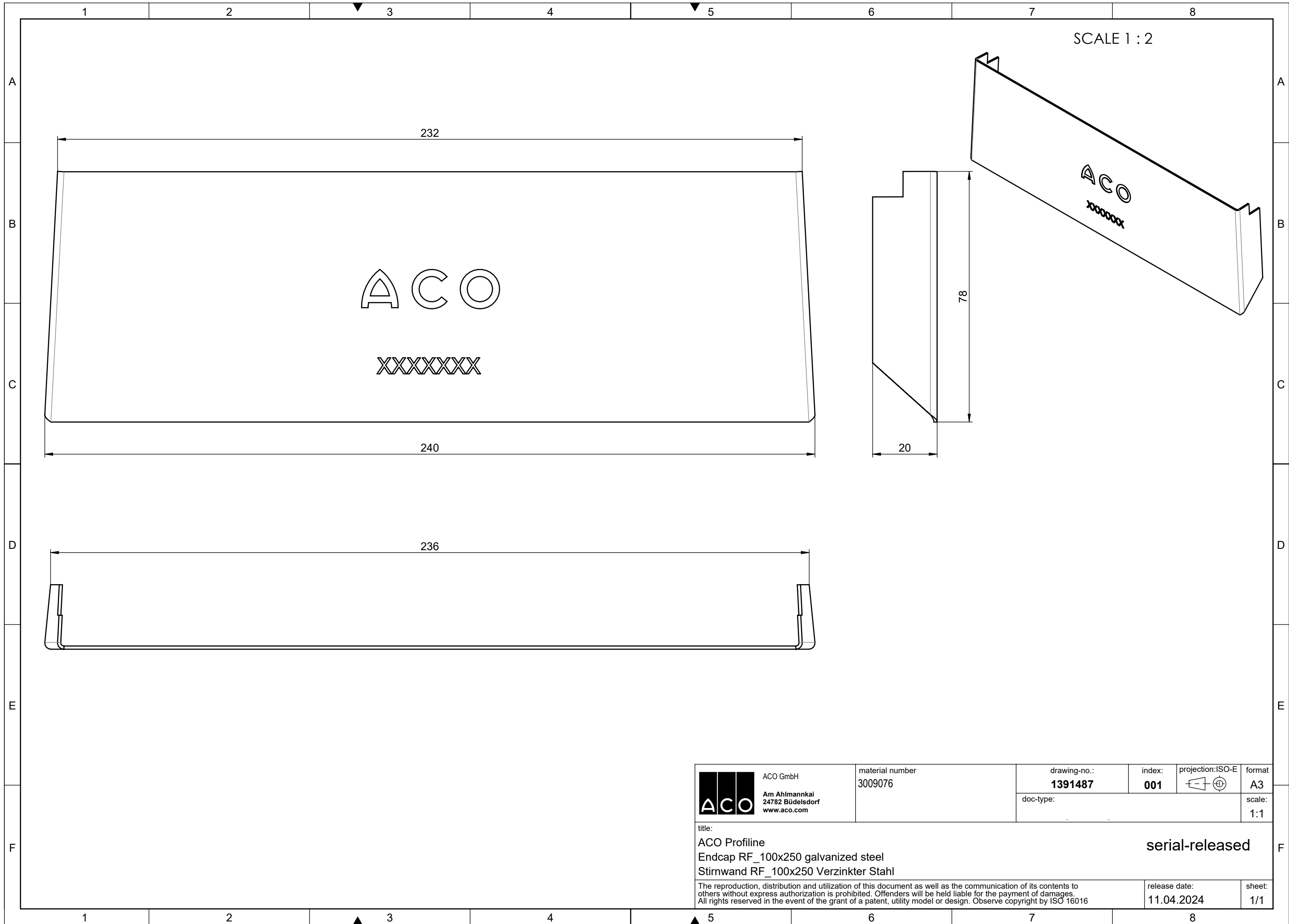

SCALE 1 : 2

232

ACO



XXXXXXXX

240

78

20

236

 ACO GmbH Am Ahlmannkai 24782 Büdelsdorf www.aco.com	material number 3009076	drawing-no.: <b>1391487</b>	index: <b>001</b>	projection: ISO-E 	format A3
	doc-type:				scale: 1:1
title: ACO Profiline Endcap RF_100x250 galvanized steel Stirnwand RF_100x250 Verzinkter Stahl					serial-released
The reproduction, distribution and utilization of this document as well as the communication of its contents to others without express authorization is prohibited. Offenders will be held liable for the payment of damages. All rights reserved in the event of the grant of a patent, utility model or design. Observe copyright by ISO 16016				release date: 11.04.2024	sheet: 1/1