

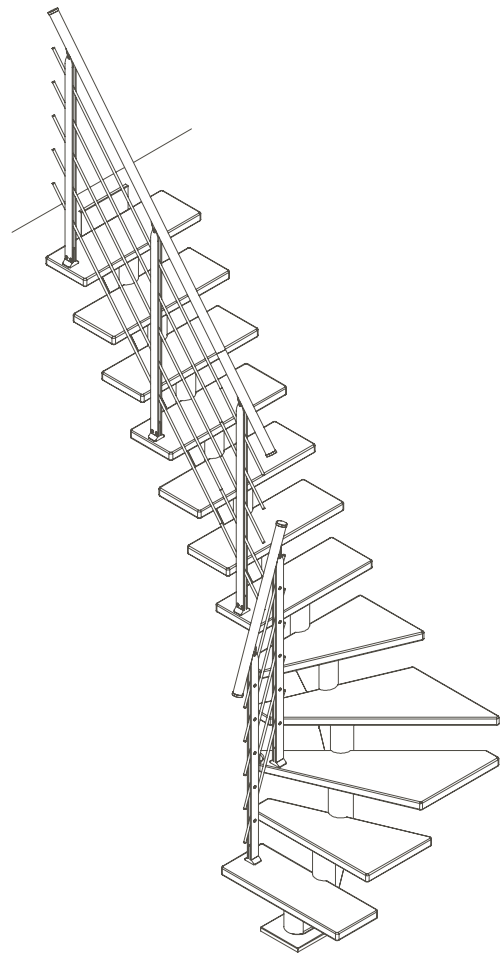

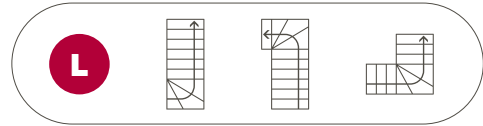

# FRANKFURT

## MASSE

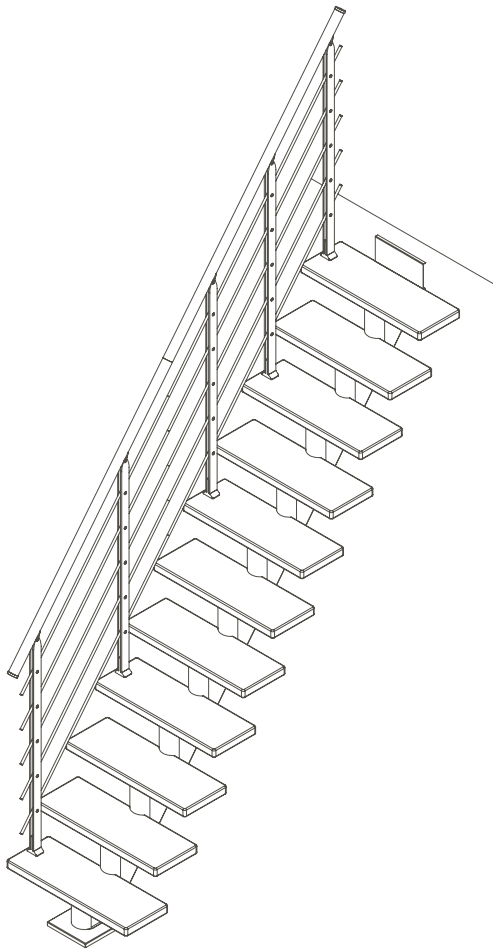
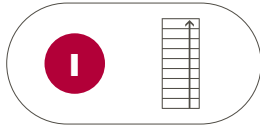

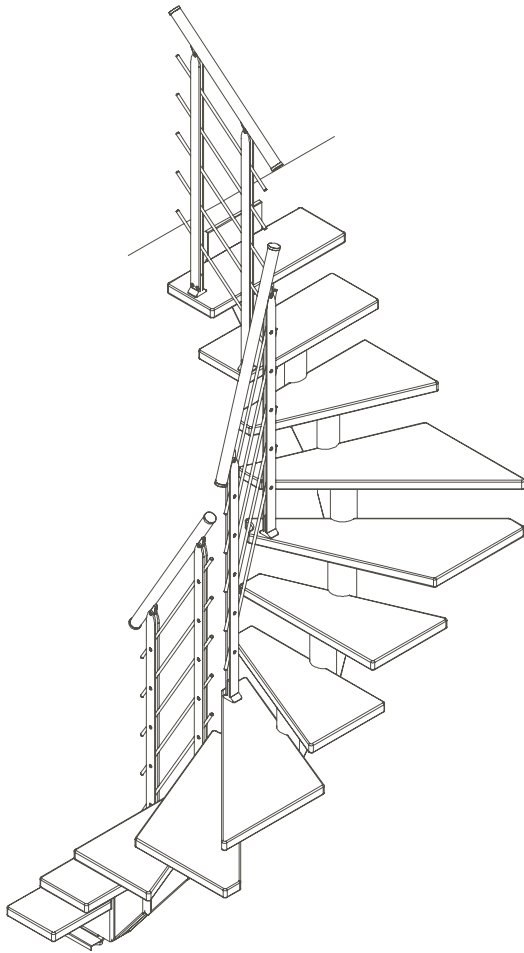
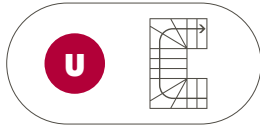
 Video: [www.dolle.de/frankfurt](http://www.dolle.de/frankfurt)







 Video: [www.dolle.de/frankfurt](http://www.dolle.de/frankfurt)

# BEZEICHNUNGEN

**C1**
**E**
**G**
**H**
**M**

	Staircase width w. 1 banister	Headroom	Going (of tread)	Height floor-to-floor	Upper floor opening length - min.
	Escalier à 1 rampe	Echappée	Giron	Hauteur sol-sol	Longueur de trémie min.
	Trappe bredde m. 1 gelænder	Frihøjde	Grund	Etagehøjde	Hulmål længde min.
	Trappbredd med 1 räcke	Frihöjd	Grund	Golv till golv höjd	Hålmått längd min.
	Treppenbreite inkl. 1 Geländer	Kopffreiheit	Auftrittsbreite	Geschosshöhe	Öffnungsgröße länge min.

**N**
**O**
**P**
**R**
**R1**

	Upper floor opening width - min.	Clear width	Pitch	Total going length	Total going width
	Largeur de trémie min.	Largeur utile	Pente de l'escalier	Recul total - longueur	Recul total - largeur
	Hulmål bredde min.	Fri bredde	Stjghed/hældning	Udladning længde	Udladning bredde
	Hålmått bredd min.	Fri bredd	Hällning	Trapplängd	Trappbredd
	Öffnungsgröße breite min.	Durchgangsmaß	Winkel	Ausladung länge	Ausladung breite

**S**
**T**
**V**
**W**
**X**

	Rise height	Number of treads	Tread depth	Tread width	Tread thickness
	Hauteur de marche	Nombre de marches	Profondeur de marche	Largeur de marche	Epaisseur de marche
	Stigningshøjde	Antal trin	Trin dybde	Trin bredde	Trin tykkelse
	Stigningshöjd	Antal steg	Stegdjup	Stegbredd	Stegjocklek
	Steigungshöhe	Anzahl Stufen	Stufen tiefe	Stufen breite	Stufen Stärke

**Z**

	Deck thickness
	Epaisseur de dalle
	Dæk tykkelse
	Bjälklagstjocklek
	Deckenstärke

# MASSE

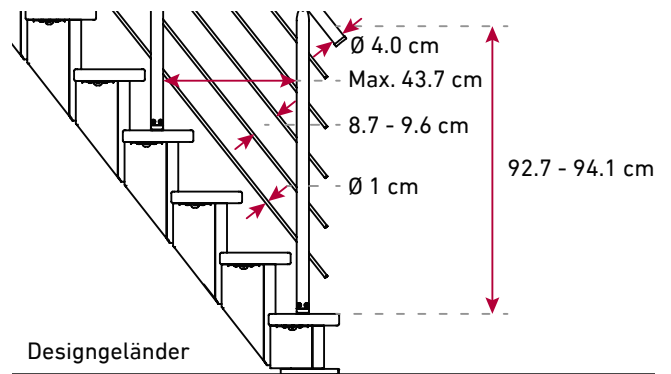
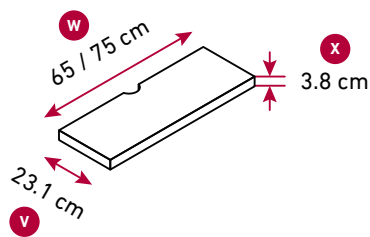
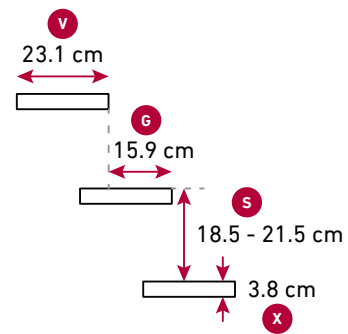
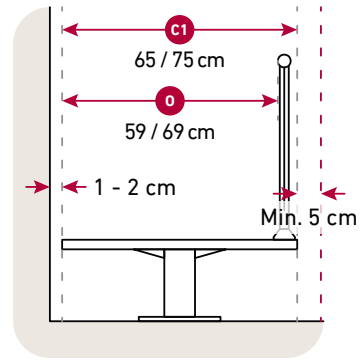
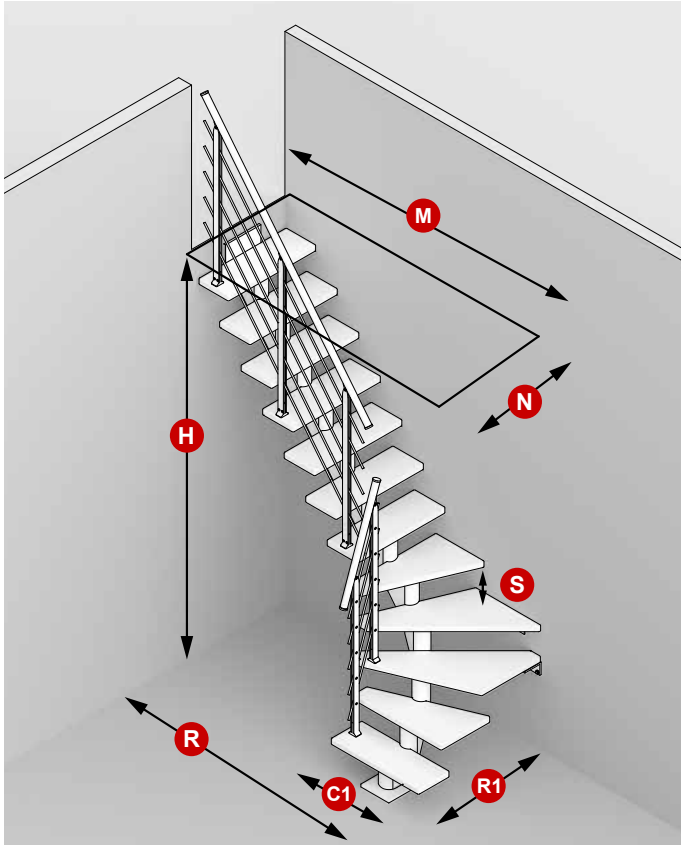

Breite 65 / 75 cm
A 94 / 99 cm
B 110 / 115 cm
C 126 / 131 cm
D 142 / 147 cm
E 158 / 163 cm
F 174 / 179 cm
G 189 / 194 cm
H 205 / 210 cm
I 219 / 224 cm

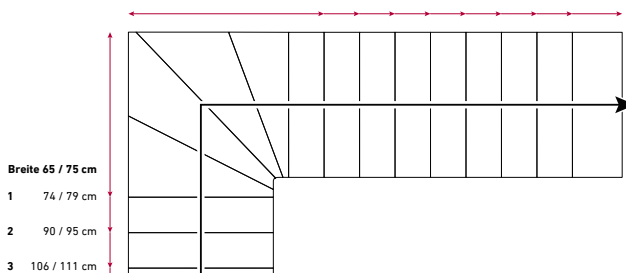

Breite 65 / 75 cm
A 94 / 99 cm
B 110 / 115 cm
C 126 / 131 cm
D 142 / 147 cm
E 158 / 163 cm

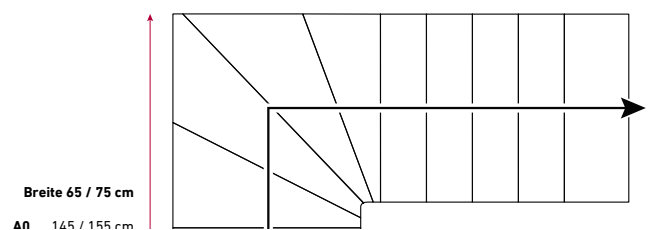

# MASSE

- H** (13T) 259 - 301 cm
- (12T) 240.5 - 279.5 cm
- (11T) 222 - 258 cm
- (10T) 203.5 - 236.5 cm
- (9T) 185 - 215 cm

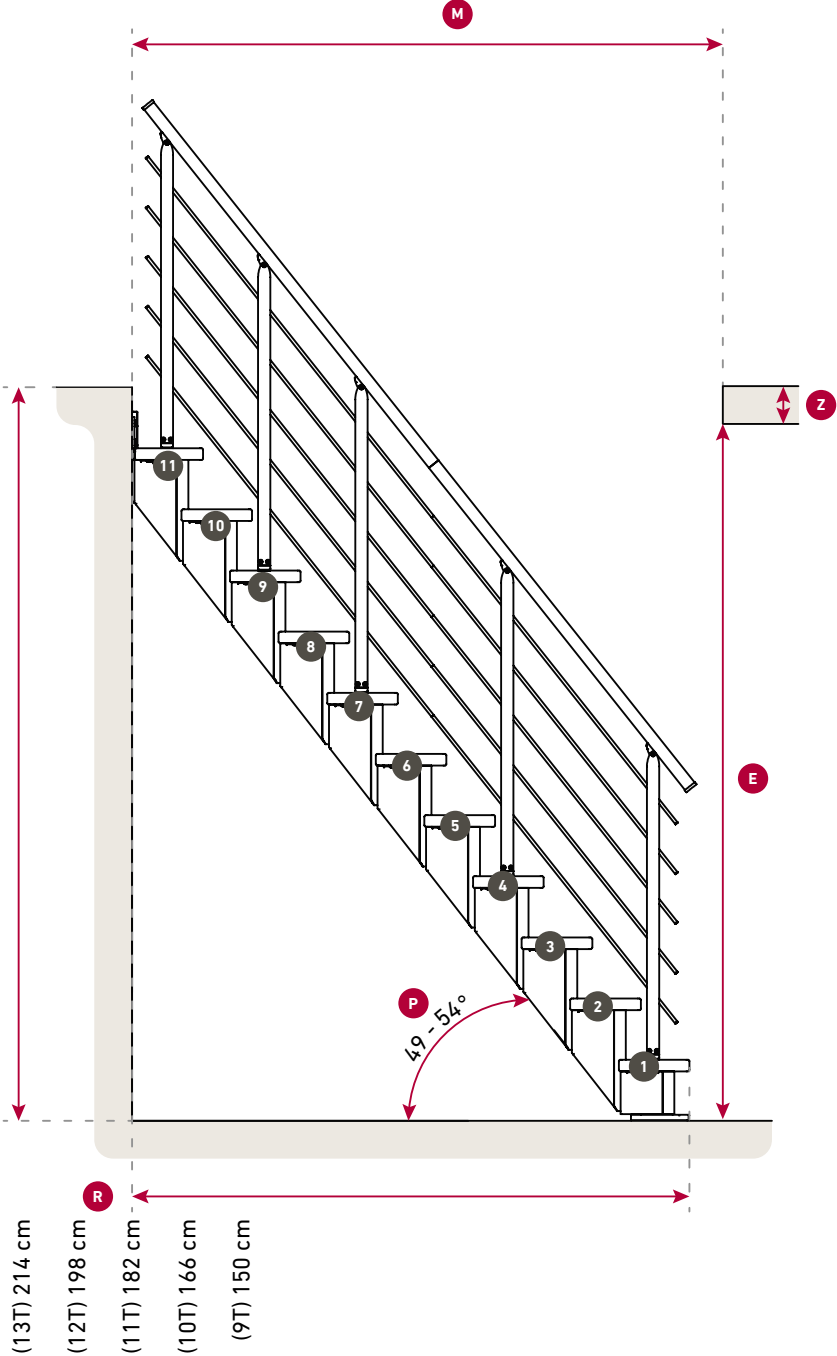

# FRANKFURT 11 STUFEN – BREITE 65 CM

H 222 - 258 cm

— Treppenmaße inkl. einseitigem Designgeländer

--- Die Größe der Deckenöffnung in diesen Beispielen basiert auf den Annahmen: 2 cm Abstand zur Wand, 5 cm Abstand für die Hand, 19 cm Steigungshöhe, 25 cm Deckenstärke, 200 cm Kopfhöhe.

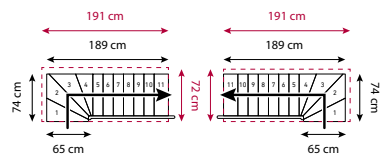
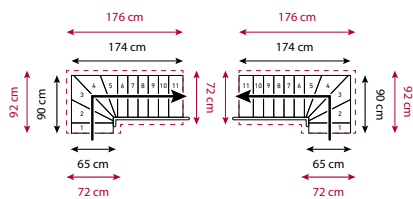
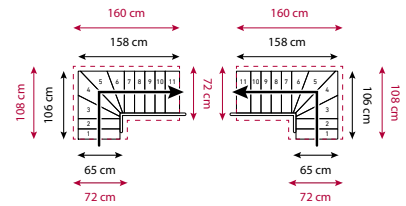
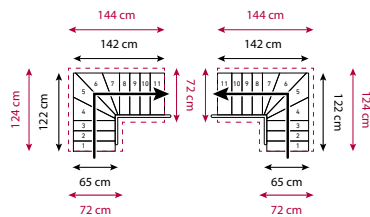
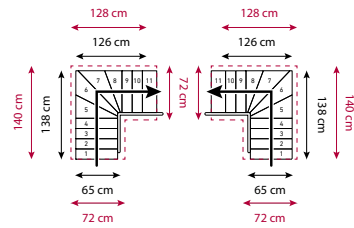
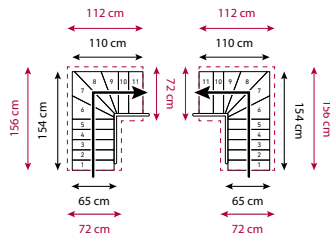
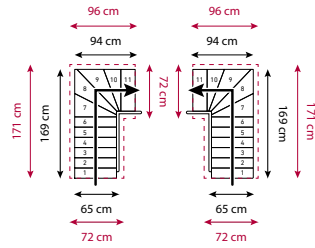
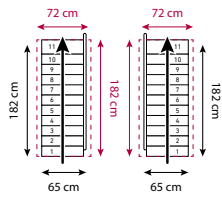

# FRANKFURT 11 STUFEN – BREITE 65 CM

H 228 - 300 cm

— Treppenmaße inkl. einseitigem Designgeländer

- - - Die Größe der Deckenöffnung in diesen Beispielen basiert auf den Annahmen: 2 cm Abstand zur Wand, 5 cm Abstand für die Hand, 19 cm Steigungshöhe, 25 cm Deckenstärke, 200 cm Kopfhöhe.

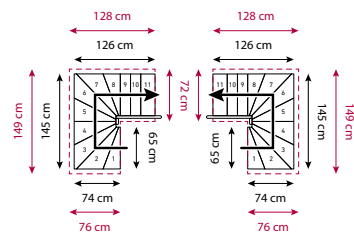
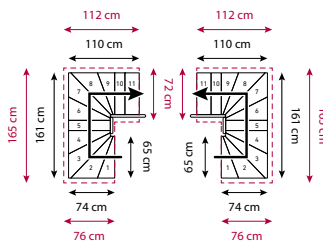
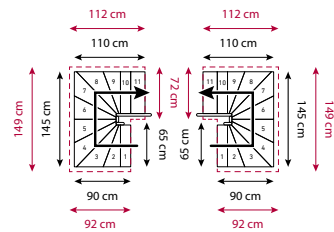
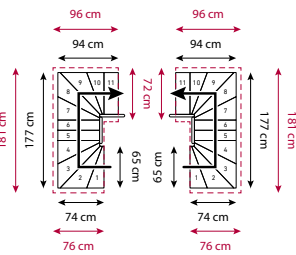
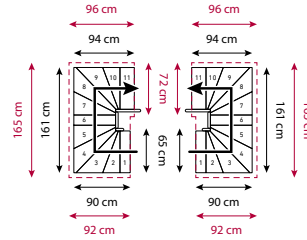
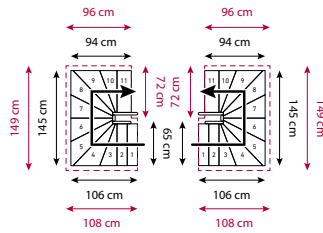



# FRANKFURT 12 STUFEN – BREITE 65 CM

H 240.5 - 279.5 cm

— Treppenmaße inkl. einseitigem Designgeländer

- - Die Größe der Deckenöffnung in diesen Beispielen basiert auf den Annahmen: 2 cm Abstand zur Wand, 5 cm Abstand für die Hand, 19 cm Steigungshöhe, 25 cm Deckenstärke, 200 cm Kopfhöhe.

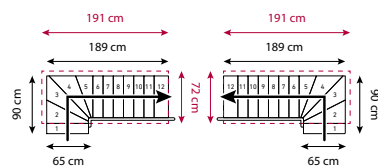
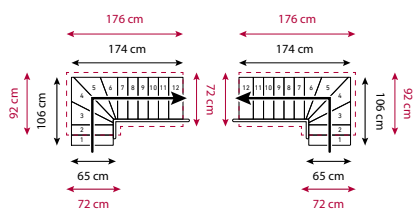
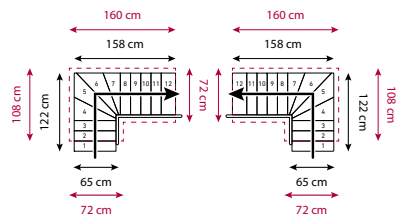
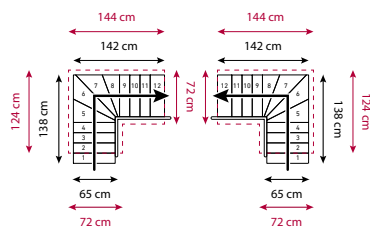
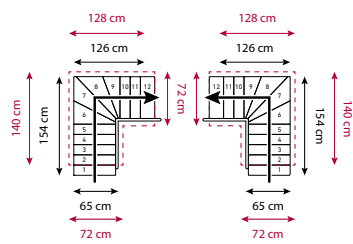
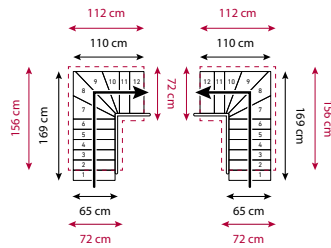
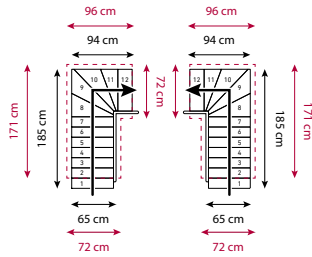
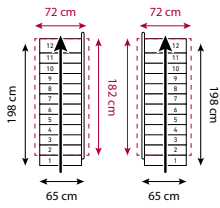

# FRANKFURT 12 STUFEN – BREITE 65 CM

H 240.5 - 279.5 cm

— Treppenmaße inkl. einseitigem Designgeländer

- - Die Größe der Deckenöffnung in diesen Beispielen basiert auf den Annahmen: 2 cm Abstand zur Wand, 5 cm Abstand für die Hand, 19 cm Steigungshöhe, 25 cm Deckenstärke, 200 cm Kopfhöhe.

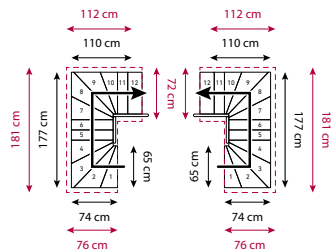
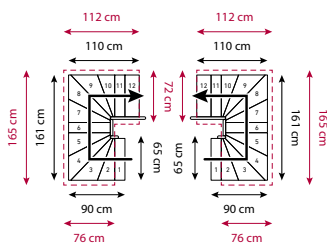
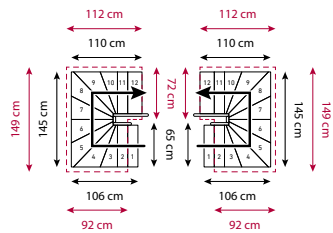
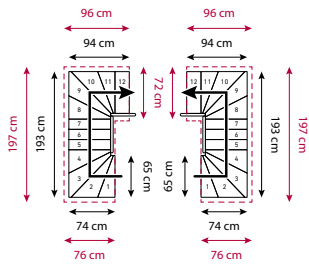
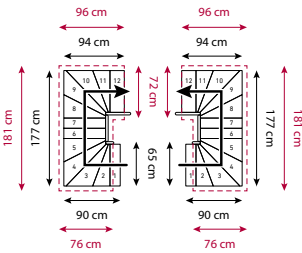
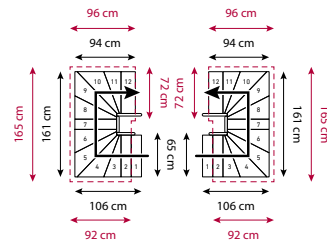
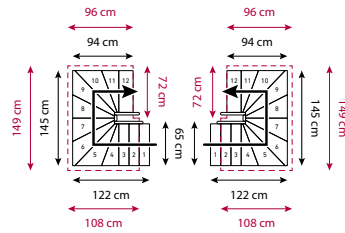
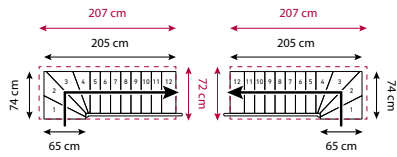

# FRANKFURT 12 STUFEN – BREITE 65 CM

H 240.5 - 279.5 cm

— Treppenmaße inkl. einseitigem Designgeländer

- - Die Größe der Deckenöffnung in diesen Beispielen basiert auf den Annahmen: 2 cm Abstand zur Wand, 5 cm Abstand für die Hand, 19 cm Steigungshöhe, 25 cm Deckenstärke, 200 cm Kopfhöhe.

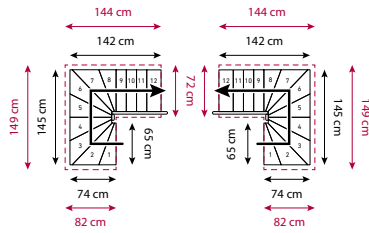
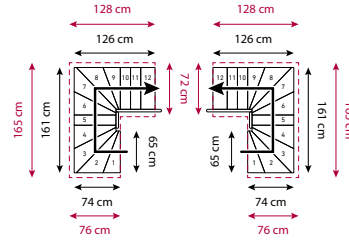
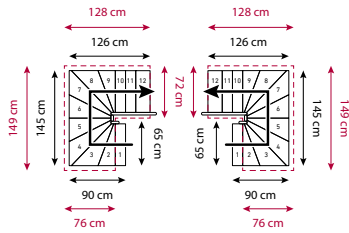

# FRANKFURT 13 STUFEN – BREITE 65 CM

H 259 - 301 cm

— Treppenmaße inkl. einseitigem Designgeländer

- - Die Größe der Deckenöffnung in diesen Beispielen basiert auf den Annahmen: 2 cm Abstand zur Wand, 5 cm Abstand für die Hand, 19 cm Steigungshöhe, 25 cm Deckenstärke, 200 cm Kopfhöhe.

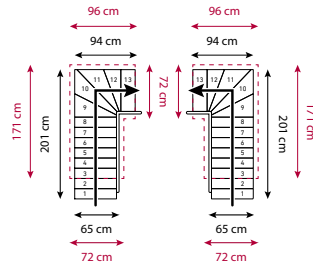
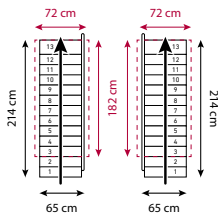

# FRANKFURT 13 STUFEN – BREITE 65 CM

H 259 - 301 cm

Treppenmaße inkl. einseitigem Designgeländer

Die Größe der Deckenöffnung in diesen Beispielen basiert auf den Annahmen: 2 cm Abstand zur Wand, 5 cm Abstand für die Hand, 19 cm Steigungshöhe, 25 cm Deckenstärke, 200 cm Kopfhöhe.

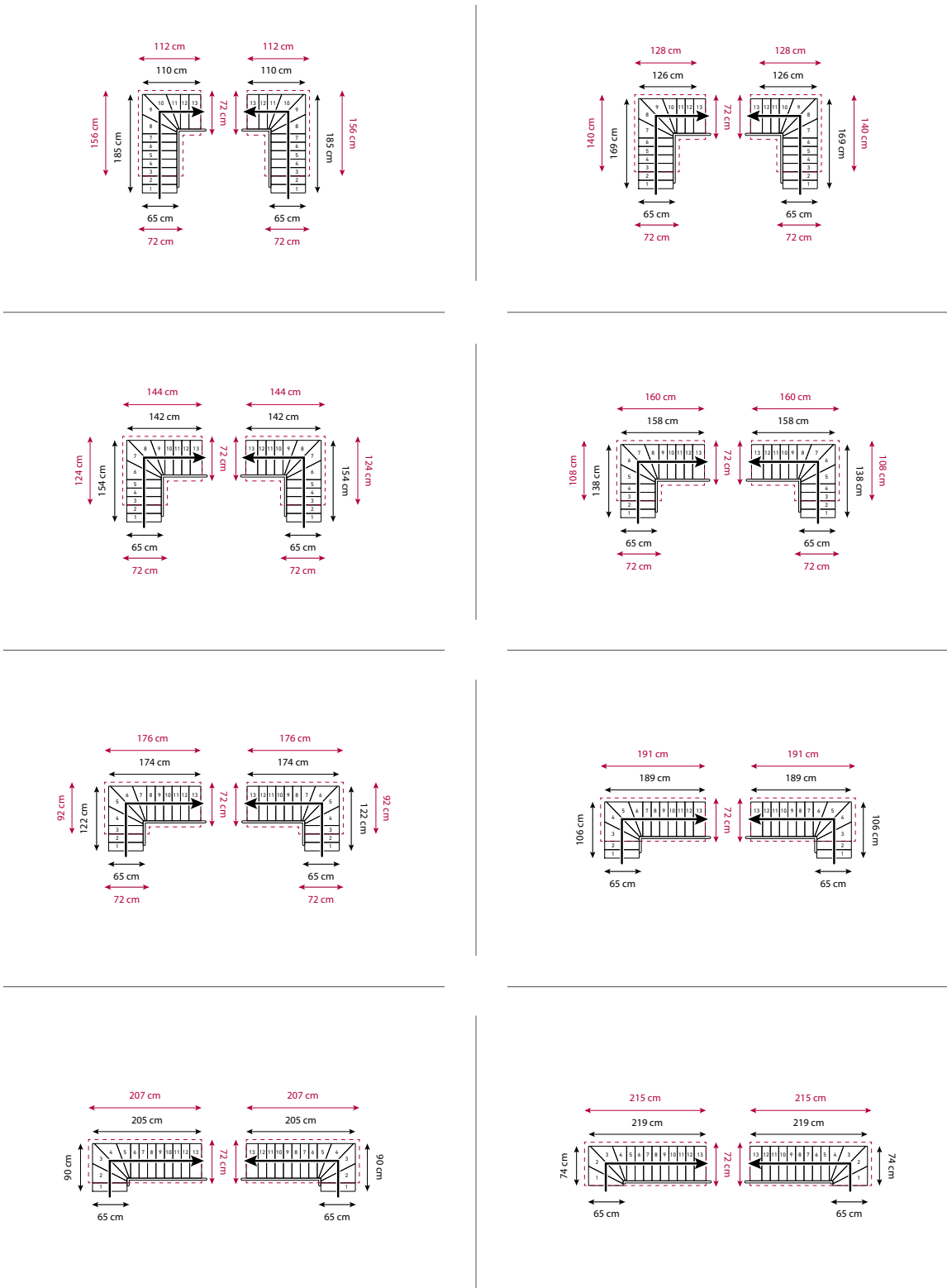

# FRANKFURT 13 STUFEN – BREITE 65 CM

H 259 - 301 cm

— Treppenmaße inkl. einseitigem Designgeländer

- - - Die Größe der Deckenöffnung in diesen Beispielen basiert auf den Annahmen: 2 cm Abstand zur Wand, 5 cm Abstand für die Hand, 19 cm Steigungshöhe, 25 cm Deckenstärke, 200 cm Kopfhöhe.

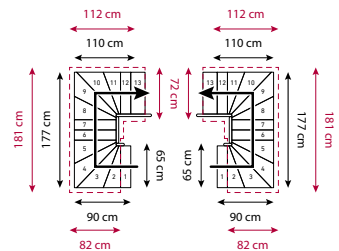
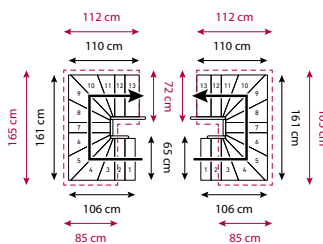
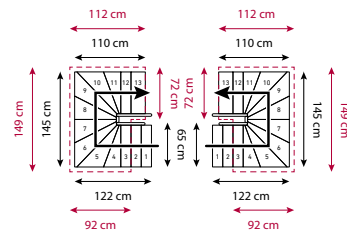
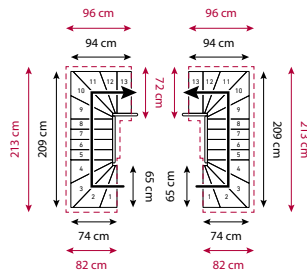
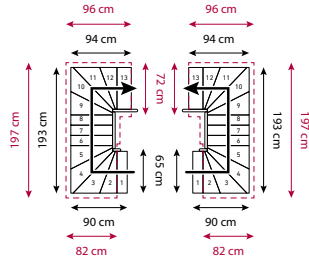
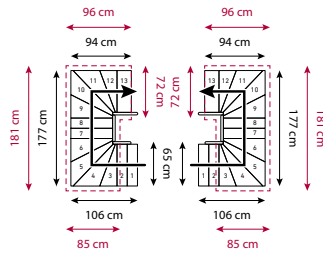
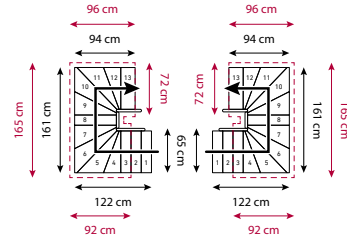
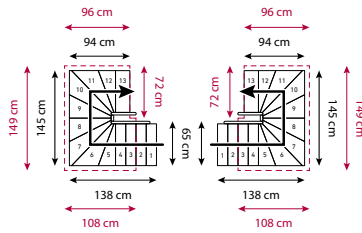

# FRANKFURT 13 STUFEN – BREITE 65 CM

H 259 - 301 cm

Treppenmaße inkl. einseitigem Designgeländer

Die Größe der Deckenöffnung in diesen Beispielen basiert auf den Annahmen: 2 cm Abstand zur Wand, 5 cm Abstand für die Hand, 19 cm Steigungshöhe, 25 cm Deckenstärke, 200 cm Kopfhöhe.

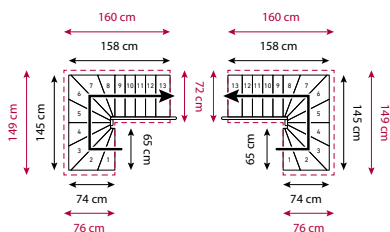
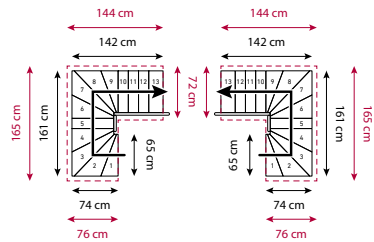
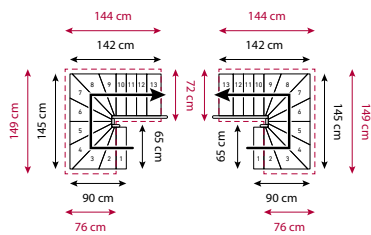
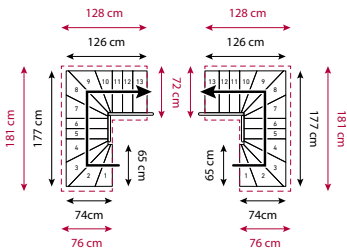
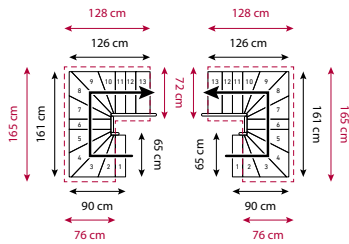
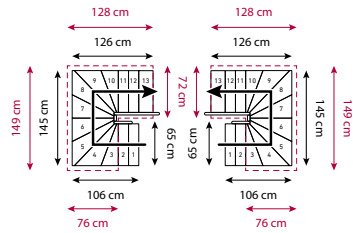
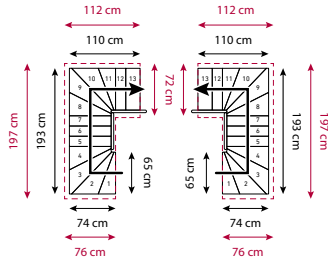

# FRANKFURT 11 STUFEN – BREITE 75 CM

H 222 - 258 cm

— Treppenmaße inkl. einseitigem Designgeländer

- - - Die Größe der Deckenöffnung in diesen Beispielen basiert auf den Annahmen: 2 cm Abstand zur Wand, 5 cm Abstand für die Hand, 19 cm Steigungshöhe, 25 cm Deckenstärke, 200 cm Kopfhöhe.

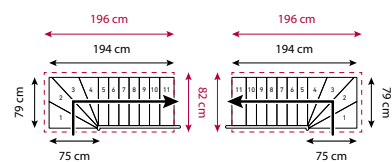
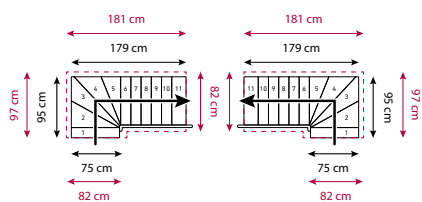
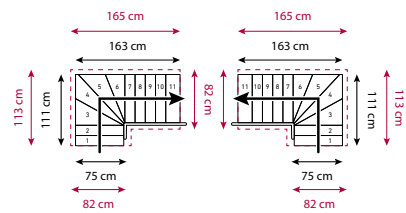
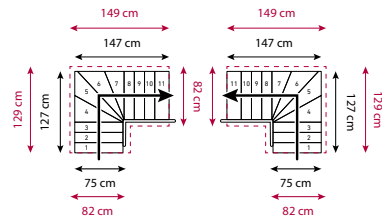
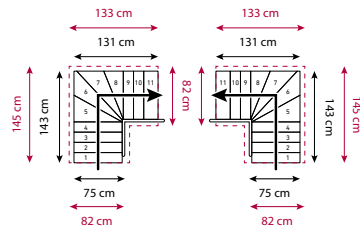
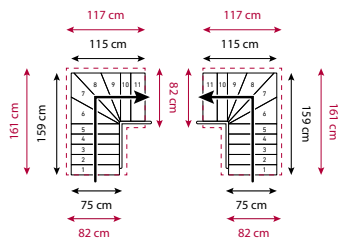
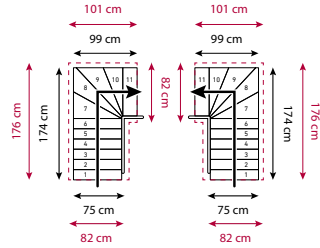
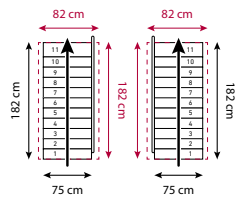

# FRANKFURT 11 STUFEN – BREITE 75 CM

H 222 - 258 cm

— Treppenmaße inkl. einseitigem Designgeländer

- - - Die Größe der Deckenöffnung in diesen Beispielen basiert auf den Annahmen: 2 cm Abstand zur Wand, 5 cm Abstand für die Hand, 19 cm Steigungshöhe, 25 cm Deckenstärke, 200 cm Kopfhöhe.

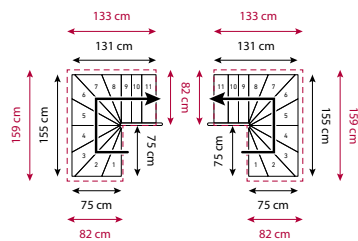
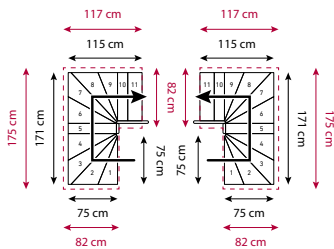
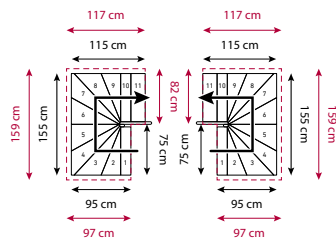
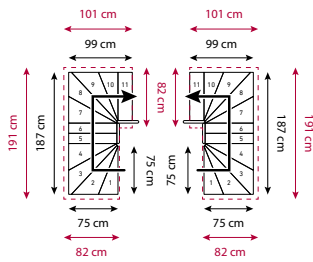
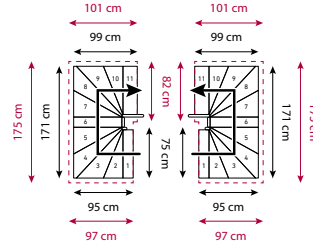
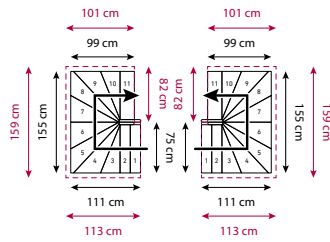



# FRANKFURT 12 STUFEN – BREITE 75 CM

H 240.5 - 279.5 cm

— Treppenmaße inkl. einseitigem Designgeländer

- - Die Größe der Deckenöffnung in diesen Beispielen basiert auf den Annahmen: 2 cm Abstand zur Wand, 5 cm Abstand für die Hand, 19 cm Steigungshöhe, 25 cm Deckenstärke, 200 cm Kopfhöhe.

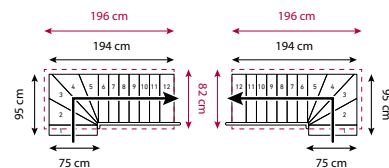
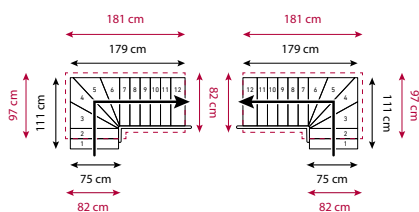
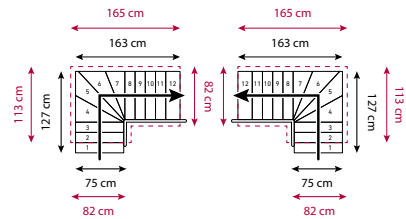
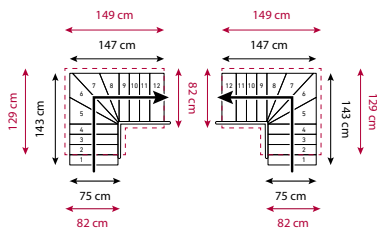
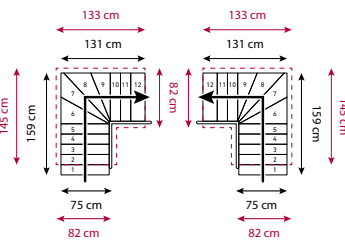
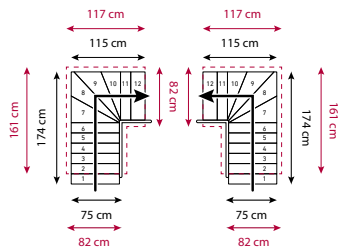
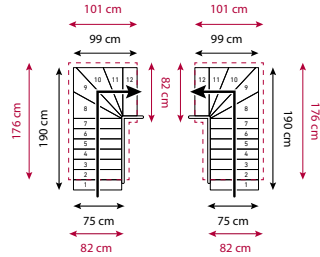
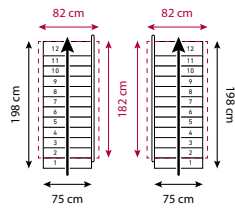

# FRANKFURT 12 STUFEN – BREITE 75 CM

H 240.5 - 279.5 cm

— Treppenmaße inkl. einseitigem Designgeländer

- - Die Größe der Deckenöffnung in diesen Beispielen basiert auf den Annahmen: 2 cm Abstand zur Wand, 5 cm Abstand für die Hand, 19 cm Steigungshöhe, 25 cm Deckenstärke, 200 cm Kopfhöhe.

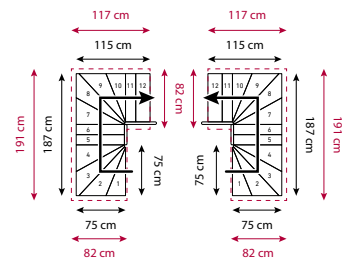
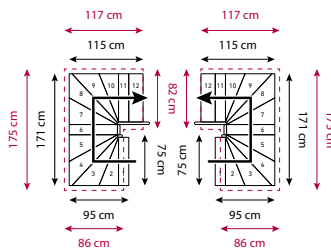
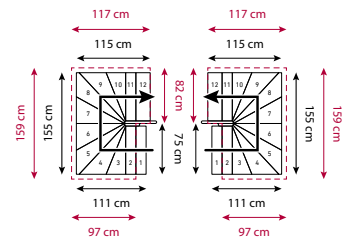
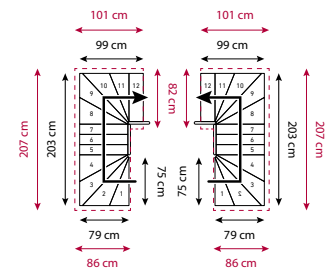
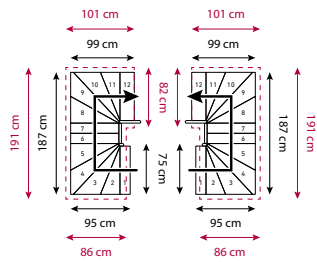
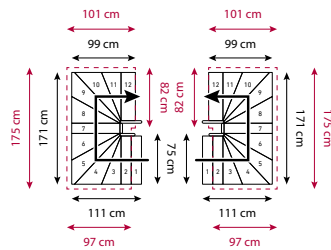
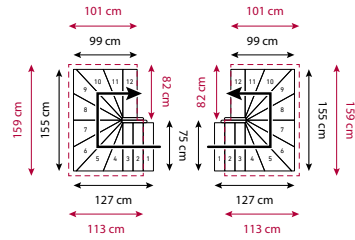
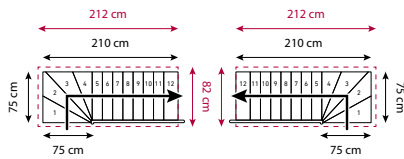

# FRANKFURT 12 STUFEN – BREITE 75 CM

H 240.5 - 279.5 cm

Treppenmaße inkl. einseitigem Designgeländer

Die Größe der Deckenöffnung in diesen Beispielen basiert auf den Annahmen: 2 cm Abstand zur Wand, 5 cm Abstand für die Hand, 19 cm Steigungshöhe, 25 cm Deckenstärke, 200 cm Kopfhöhe.

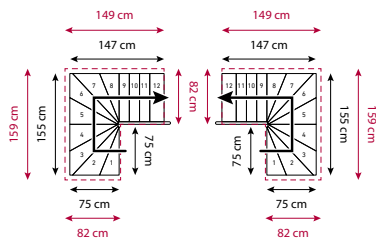
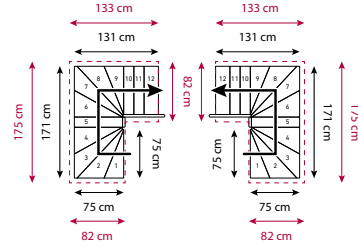
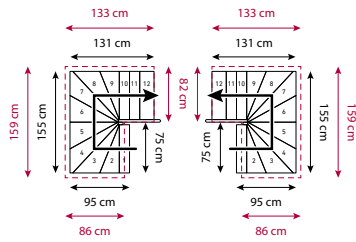

# FRANKFURT 13 STUFEN – BREITE 75 CM

H 259 - 301 cm

Treppenmaße inkl. einseitigem Designgeländer

Die Größe der Deckenöffnung in diesen Beispielen basiert auf den Annahmen: 2 cm Abstand zur Wand, 5 cm Abstand für die Hand, 19 cm Steigungshöhe, 25 cm Deckenstärke, 200 cm Kopfhöhe.

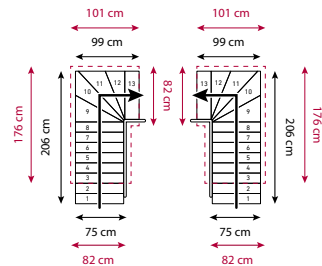
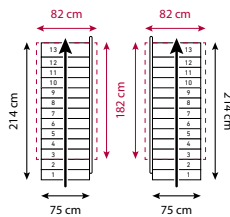

# FRANKFURT 13 STUFEN – BREITE 75 CM

H 259 - 301 cm

Treppenmaße inkl. einseitigem Designgeländer

Die Größe der Deckenöffnung in diesen Beispielen basiert auf den Annahmen: 2 cm Abstand zur Wand, 5 cm Abstand für die Hand, 19 cm Steigungshöhe, 25 cm Deckenstärke, 200 cm Kopfhöhe.



# FRANKFURT 13 STUFEN – BREITE 75 CM

**H** 259 - 301 cm

— Treppenmaße inkl. einseitigem Designgeländer

--- Die Größe der Deckenöffnung in diesen Beispielen basiert auf den Annahmen: 2 cm Abstand zur Wand, 5 cm Abstand für die Hand, 19 cm Steigungshöhe, 25 cm Deckenstärke, 200 cm Kopfhöhe.

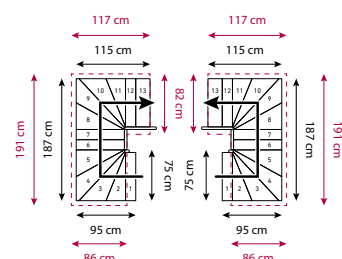
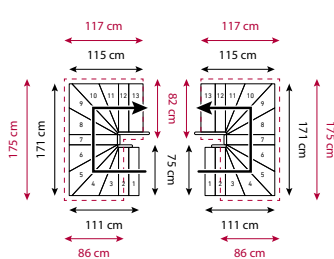
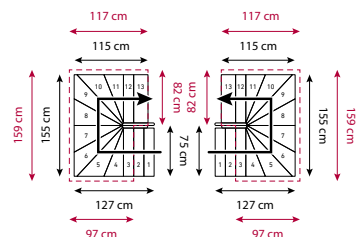
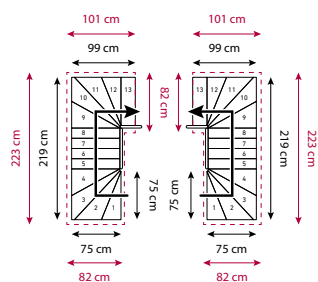
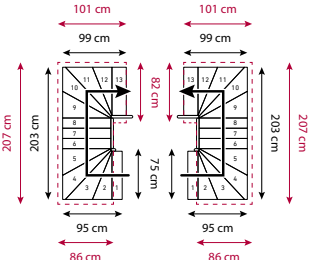
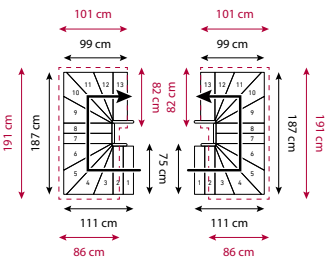
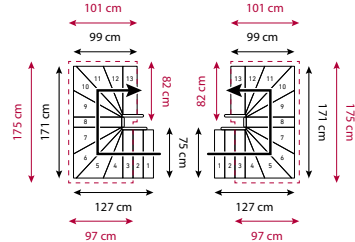
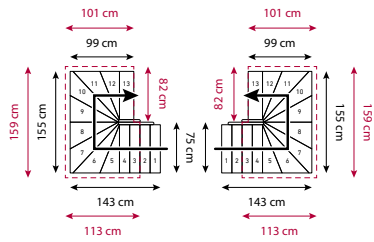

# FRANKFURT 13 STUFEN – BREITE 75 CM

H 259 - 301 cm

— Treppenmaße inkl. einseitigem Designgeländer

--- Die Größe der Deckenöffnung in diesen Beispielen basiert auf den Annahmen: 2 cm Abstand zur Wand, 5 cm Abstand für die Hand, 19 cm Steigungshöhe, 25 cm Deckenstärke, 200 cm Kopfhöhe.



# FRANKFURT 1/4-GEWENDELT

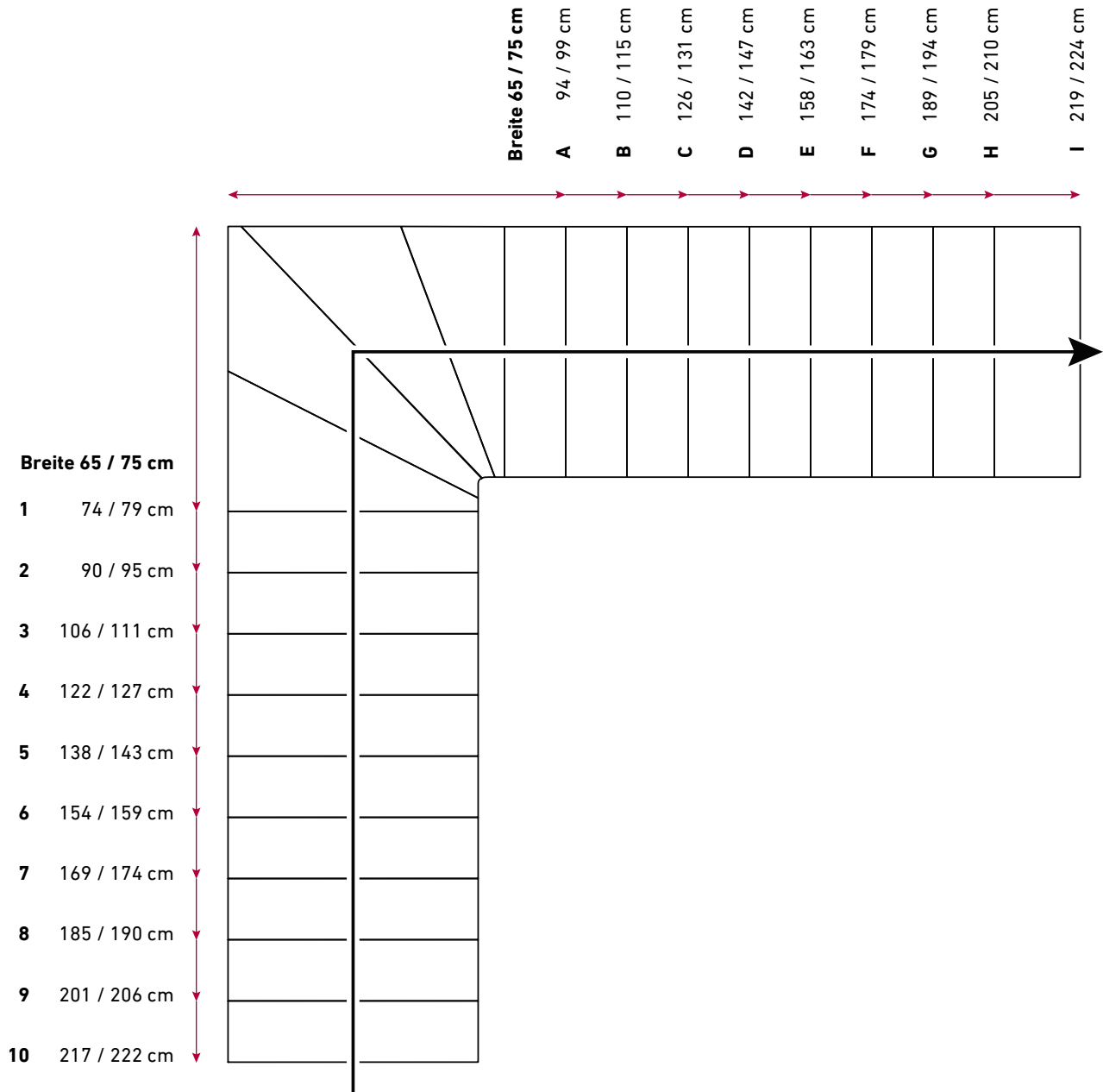

# FRANKFURT 1/2-GEWENDELT

