

# Lisa 44-A XL

Wandaußenmaß: 360 x 300 cm

Bohlenstärke: 44 mm



Lisa 44-A. Vom Kunden farblich behandelt.

Kontrolliert durch:

Achtung: Alle angegebenen Maße sind ca.-Maße!

# 3D-Darstellung Lisa 44-A XL

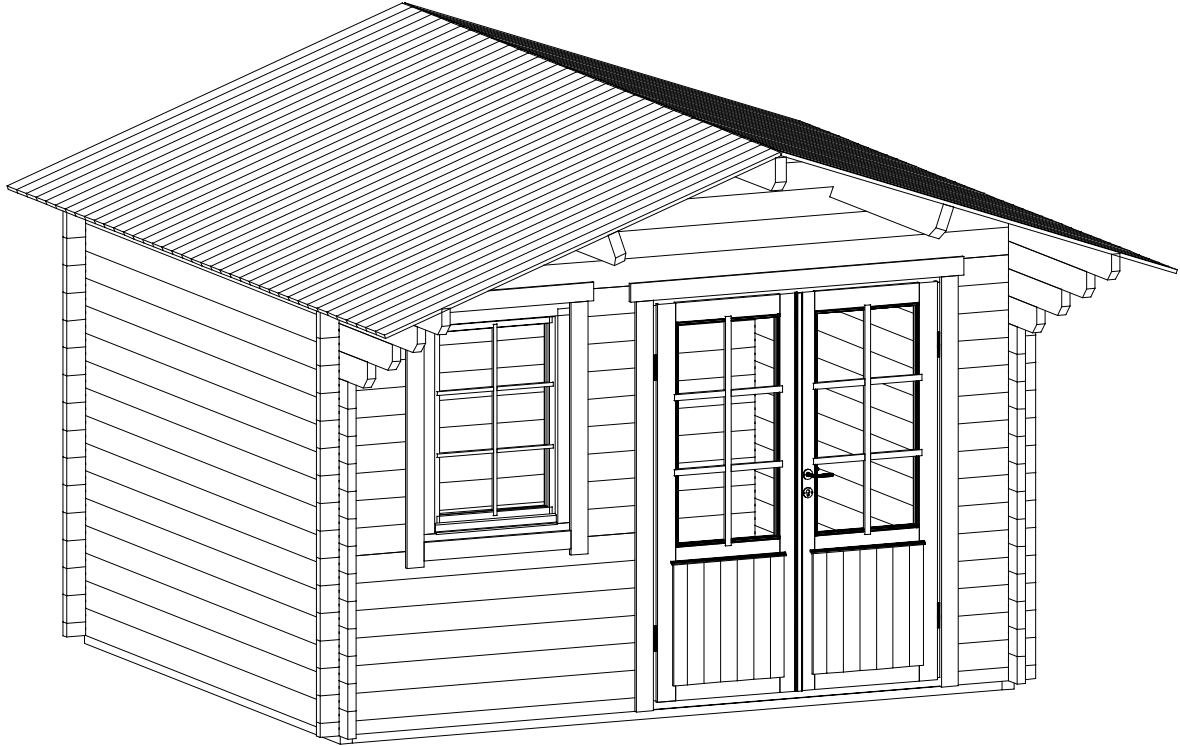

# Grundriss Lisa 44-A XL

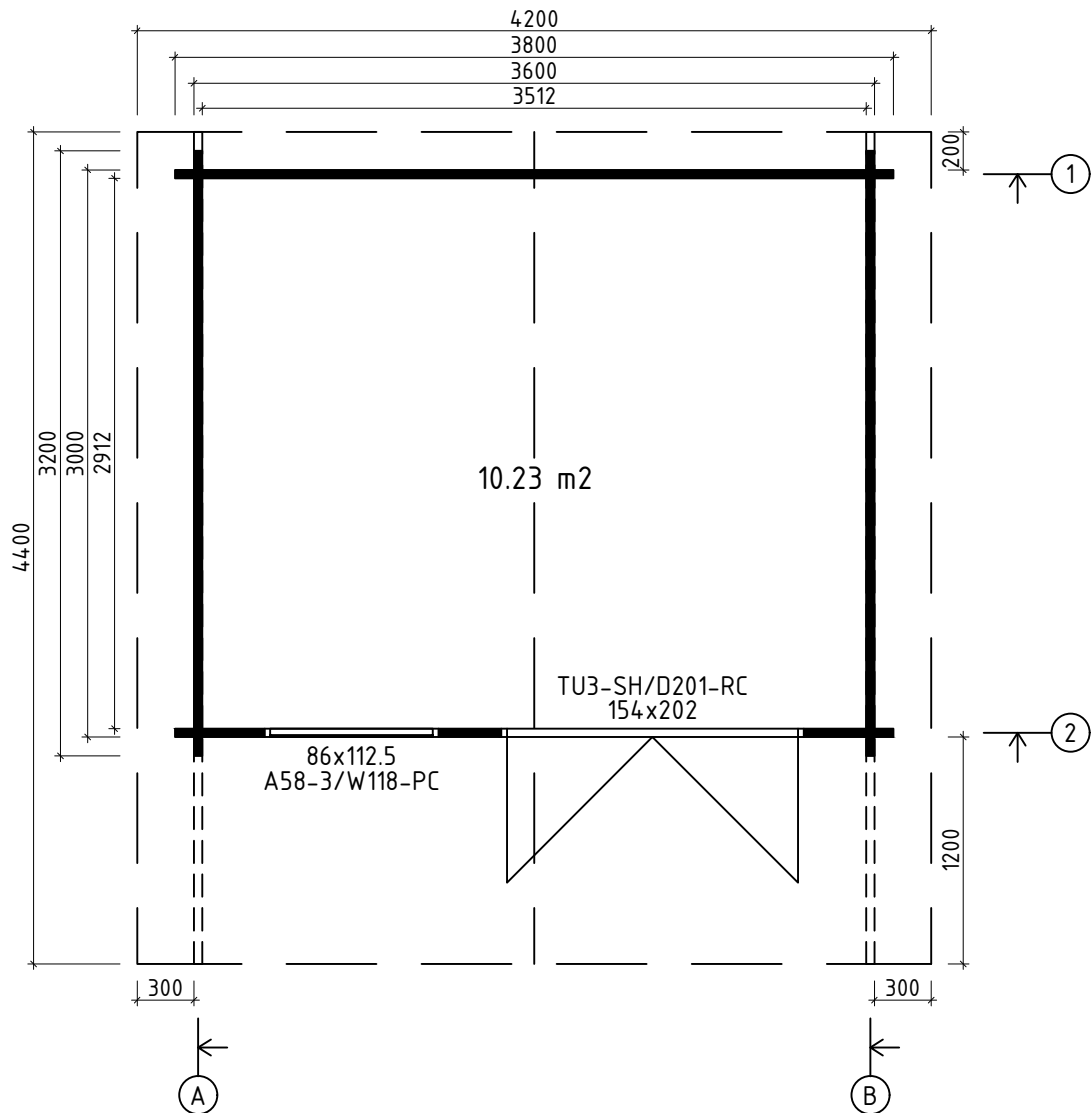

# Lagerholzplan und Fundamentplan

## Lisa 44-A XL



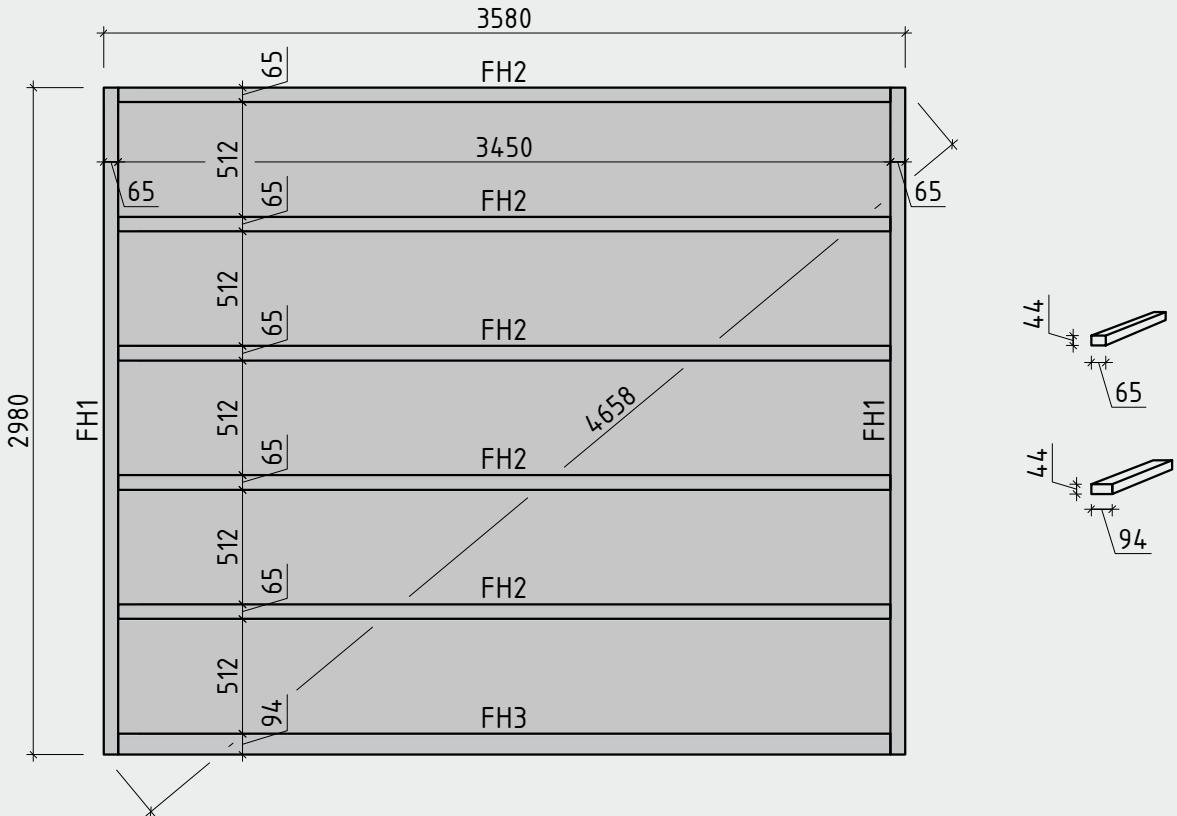







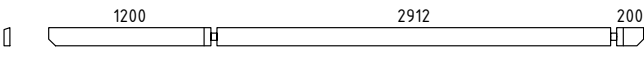
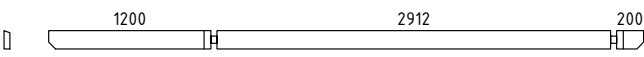
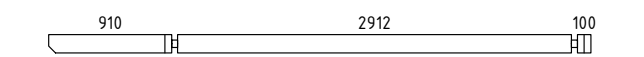
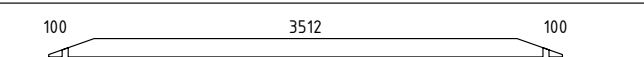
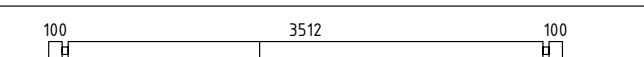
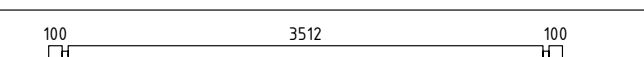
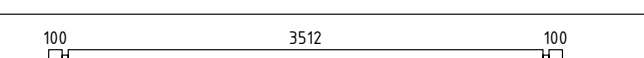
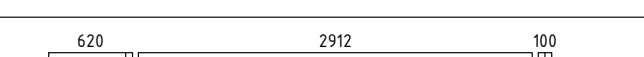
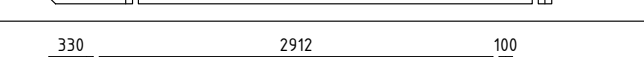
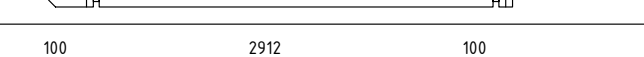
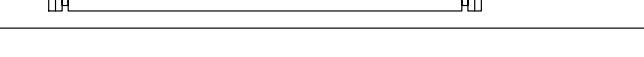
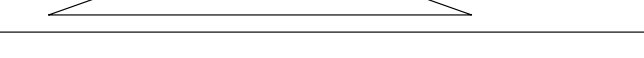
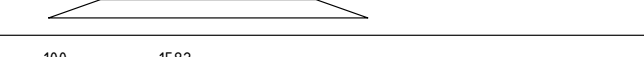

Wir empfehlen als Fundament für Ihr Gartenhaus eine vollflächig, festgegründete gepflasterte oder betonierte Fläche. Wahlweise ist auch ein Punkt- oder Streifenfundament möglich.



**Q4** – Qualitätsklasse für Fenster und Türen





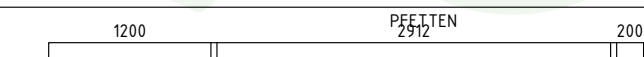





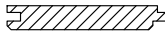





# Teileliste 1

## Lisa 44-A XL

Pos		Stck.	Profil (mm)	Länge (mm)
001		1	44x135	4400
002		1	44x135	4400
003		2	44x135	4010
004		2	44x135	3800
005		1	44x135	3800
006		16	44x135	3800
007		1	44x68	3800
008		2	44x135	3720
009		2	44x135	3430
010		26	44x135	3200
011		2	44x135	3128
012		2	44x135	2361
013		1	44x68	1726
014		5	44x135	1726
015		1	44x135	1726
016		2	44x135	1593
017		1	44x68	474
018		24	44x135	474
019		4	44x135	389
020		9	44x135	332
FH3	FUNDAMENTHÖLZER (imprägniert) 	1	94x44	3450
FH2	FUNDAMENTHÖLZER (imprägniert) 	5	65x44	3450
FH1	FUNDAMENTHÖLZER (imprägniert) 	2	65x44	2980
PF1		3	58x170	4400
	DACHBRETTER 	78+1	113x18	2226

# Teileliste 2

## Lisa 44-A XL

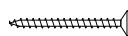
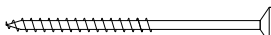
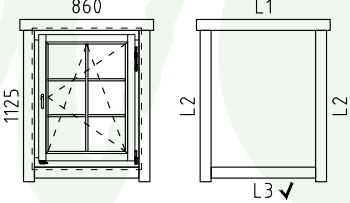
Pos		Stck	Profil (mm)	Länge (mm)
	FUSSBODENBRETTER 	32+1	113x18	2907
	FUSSBODENLEISTEN  ✓		18x40	13,0 lfm
G02-1	GIEBELBRETTER 18x120  19,4° ✓	4	18x120	2306
G06-1	GIEBELDECKLEISTEN 18x58  19,4° ✓	4	18x58	2306
T01-1	TRAUFBRETTER 18x95 	2	18x95	4400
T06-1	TRAUFNLEISTEN 18x40  ✓		18x40	9,0 lfm
GS	Giebelsegment 	2		
SH	Schlaghölzer 	3		
ML1	Metallstange 	1	D10	1440
KL1	Gewindestange M8 	4	M8	2000
KL2	Gewindestange M8 	4	M8	325
	Mutter M8 	8	M8	
	U-Scheibe M8 Ø25 	8	M8	
	Befestigungsmutter M8 	4	M8	
NG04	NÄGEL 2.5x50 Dachbretter Fussbodenbretter 	852		
SR32	SCHRAUBEN 3.0x30 Fussbodenleisten Traufenleisten 40x18 	46		
SR37	SCHRAUBEN 3.5x45 Giebelbretter, Traufenleisten 18x58 Giebelsegment, Fenster- und Türleisten 	110		
SR57	SCHRAUBEN 5.0x100 Fundamenthölzer 	32		
	FENSTER <u>Q4</u> W4-S44P-06C-08601125  A58-3 / W118-PC L1 18x90 L=1100mm 2x L2 18x90 L=1125mm 4x L3 18x90 L=860mm 2x ✓	1		

# Teileliste 3

## Lisa 44-A XL

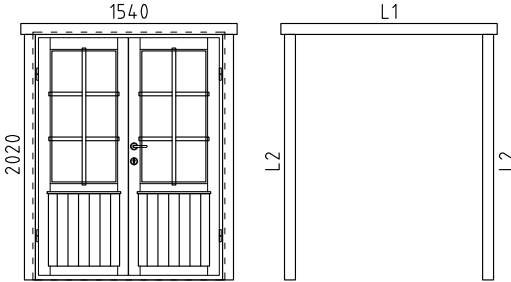
Pos		Stck	Profil (mm)	Länge (mm)
TÜR <u>Q4</u>	D4-D44R-56C-15402020	1		
	 <p>TU3-SH / D201-RC</p> <p>L1 18x90 L=1780mm 2x            L2 18x90 L=2020mm 4x ✓</p> <p>DIN rechts</p>			
✓	- bitte selber anpassen (falls nötig)!			

# Wandplan 1 und 2

## Lisa 44-A XL

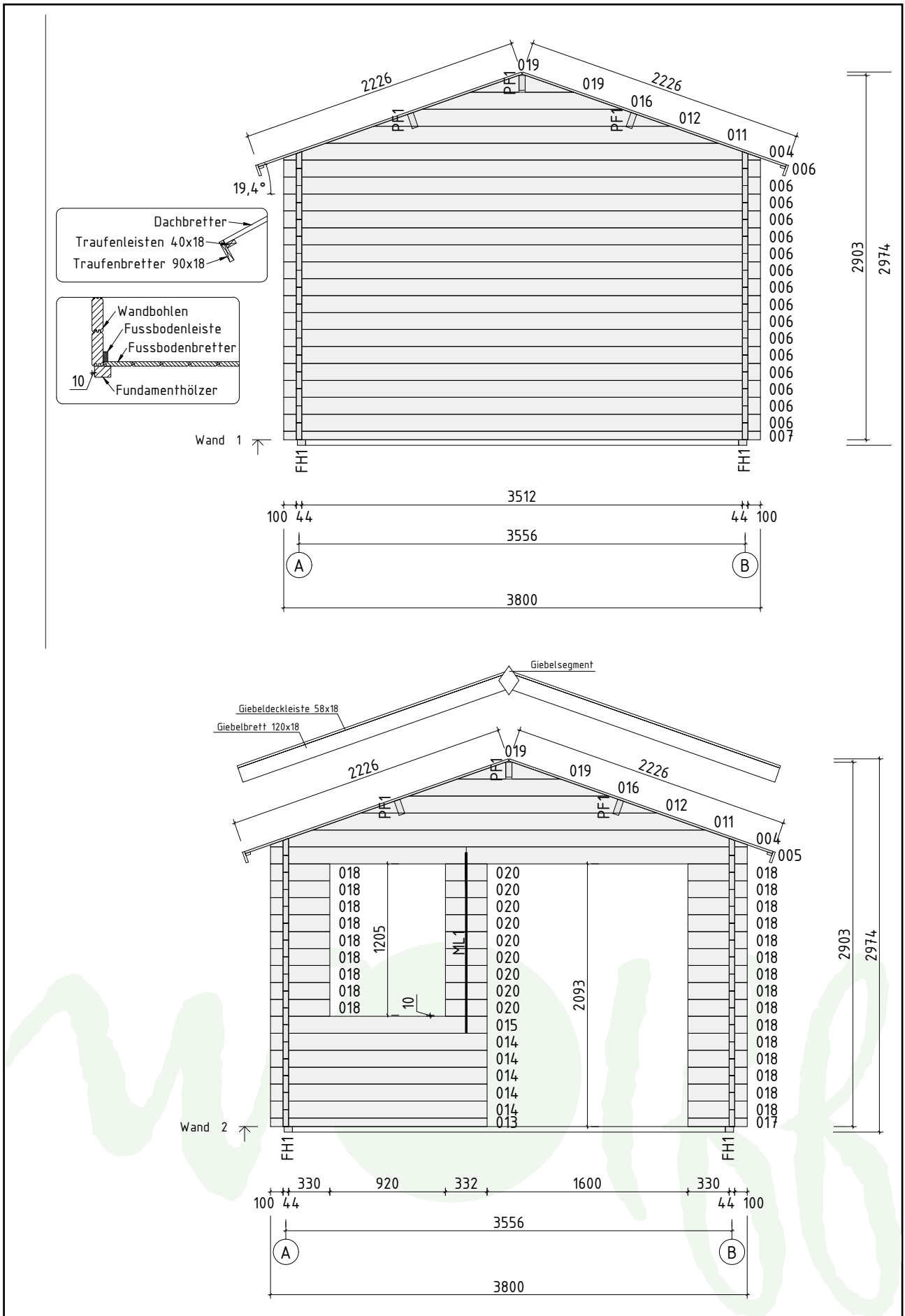



# Wandplan A und B

## Lisa 44-A XL

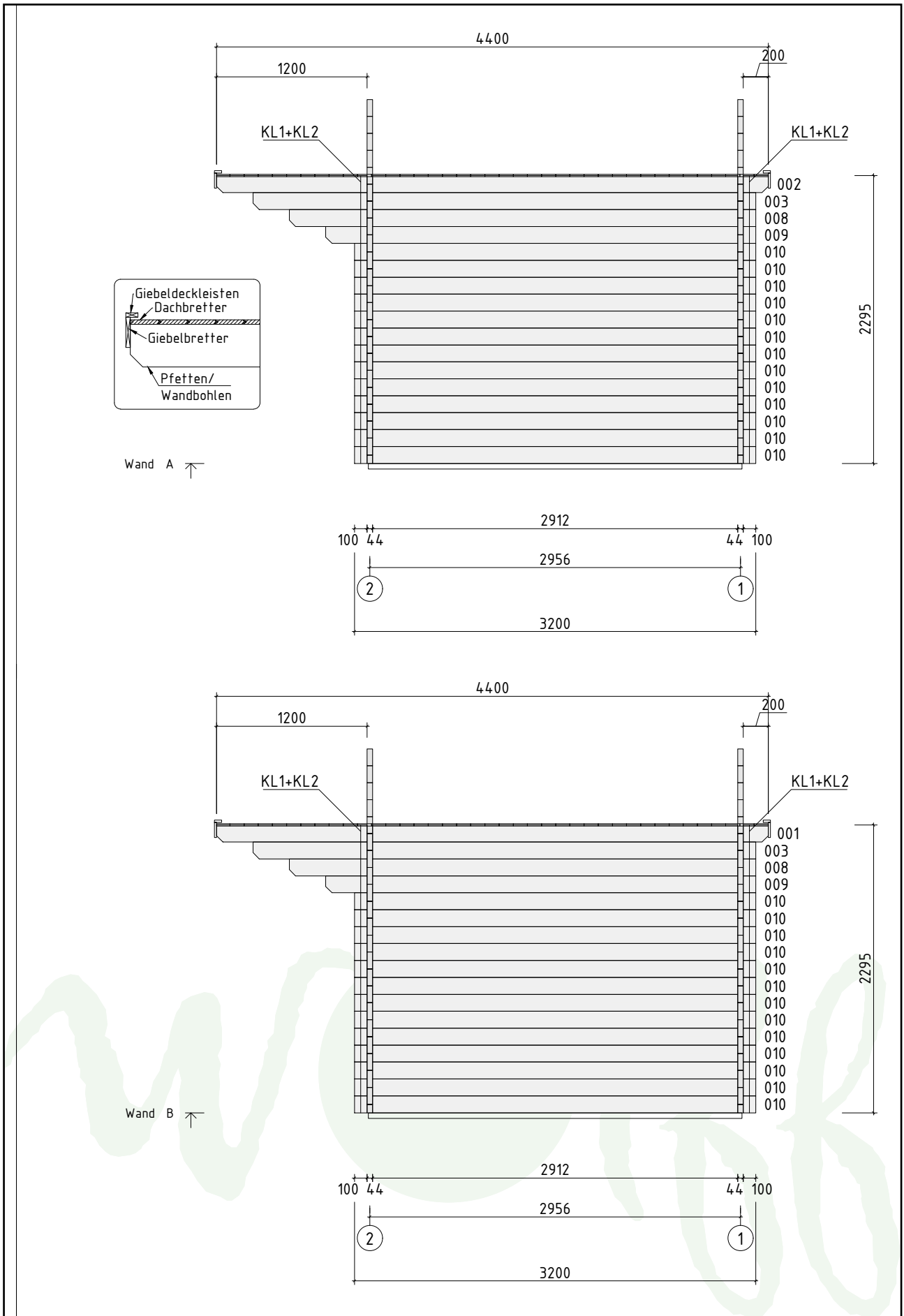

# Details

## Lisa 44-A XL

Akna tüüp / Fenster typ / Window type - A68  
(GH+ / SH)

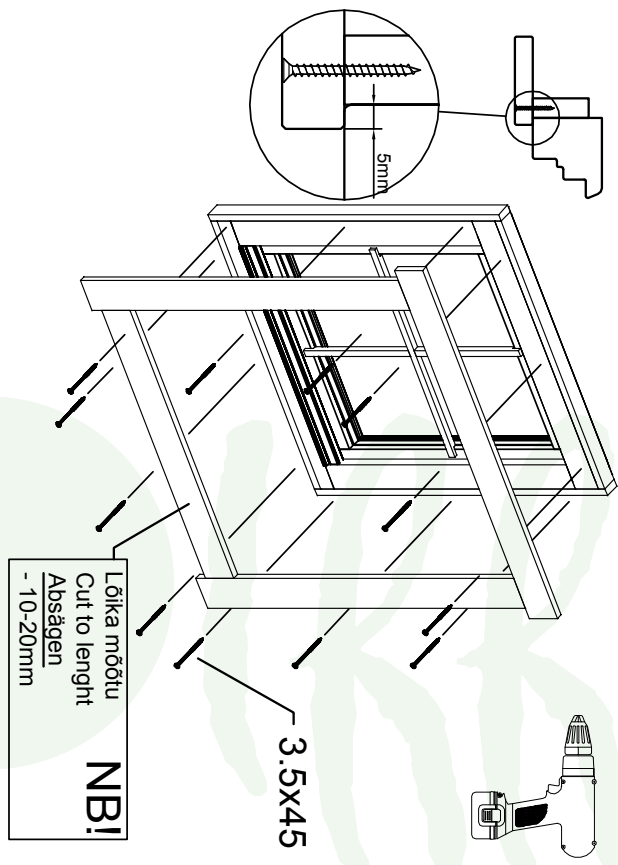
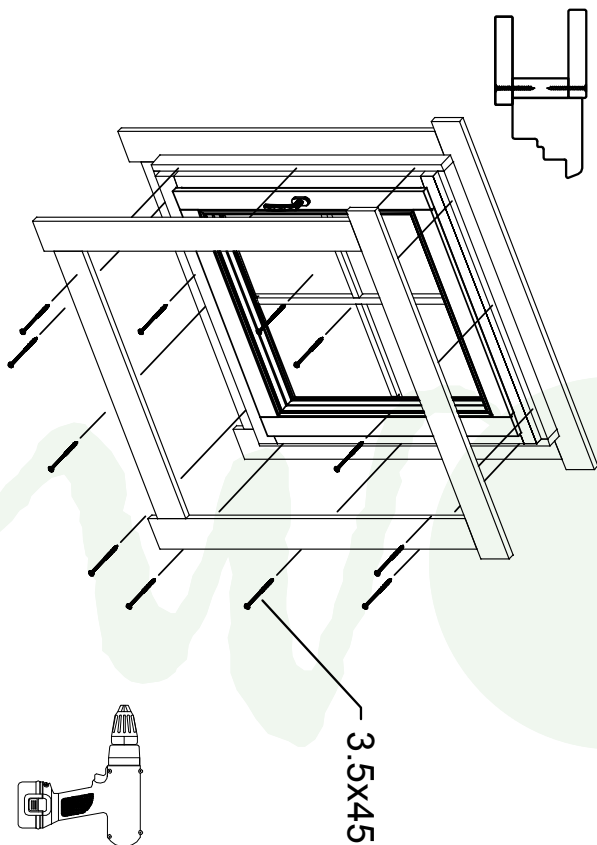
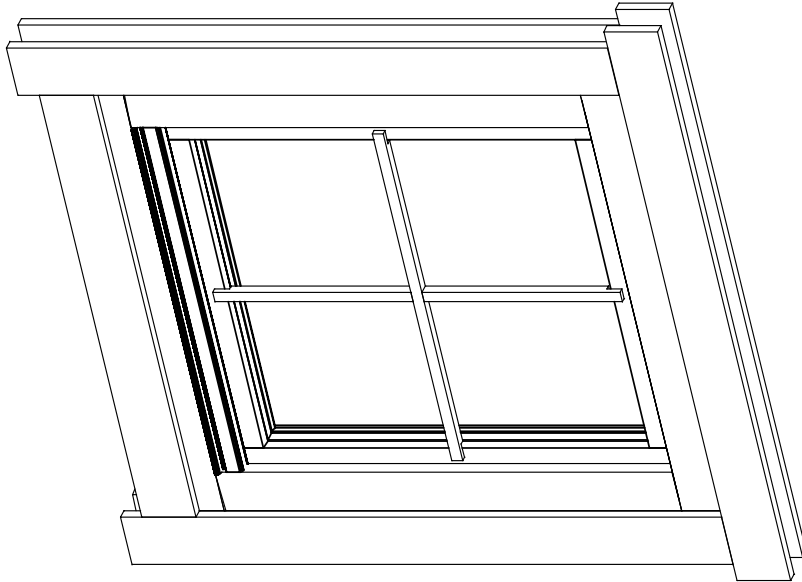

# Details

## Lisa 44-A XL

Uksee montaaž / Tür montage / Door assembly  
(GH+ / SH)

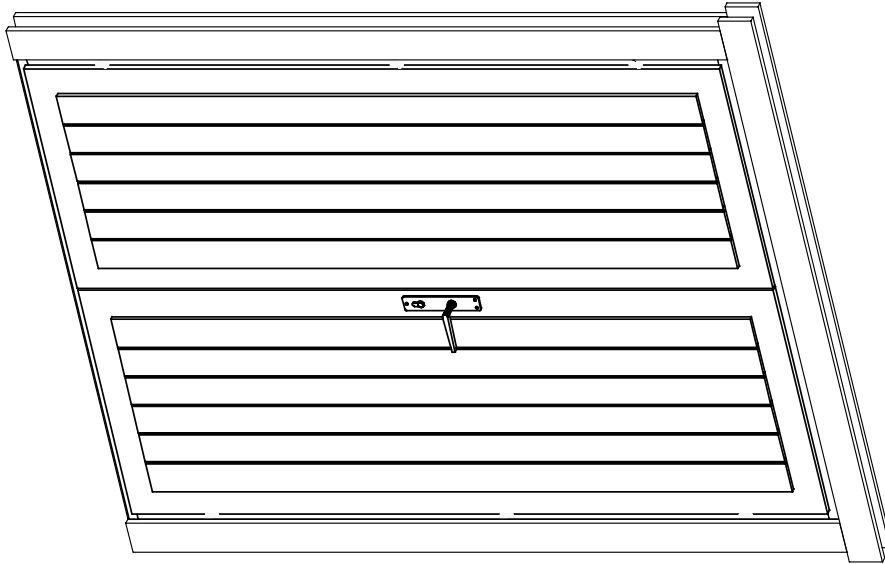

# Details

## Lisa 44-A XL

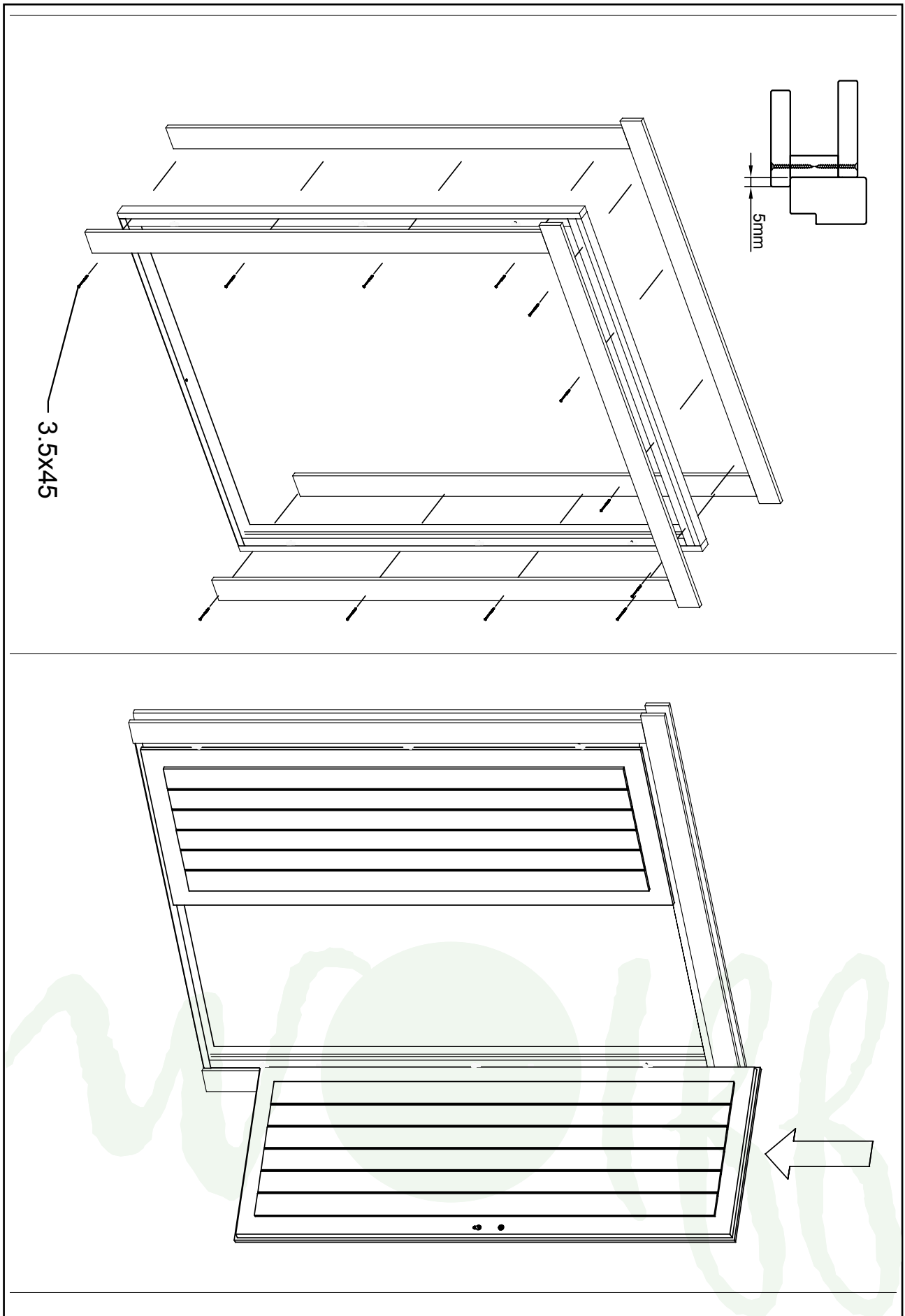

# Details

## Lisa 44-A XL

