

Technische Daten

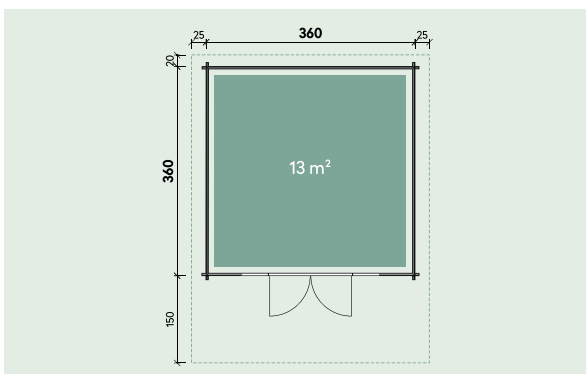

Artikelnummer:

870 510





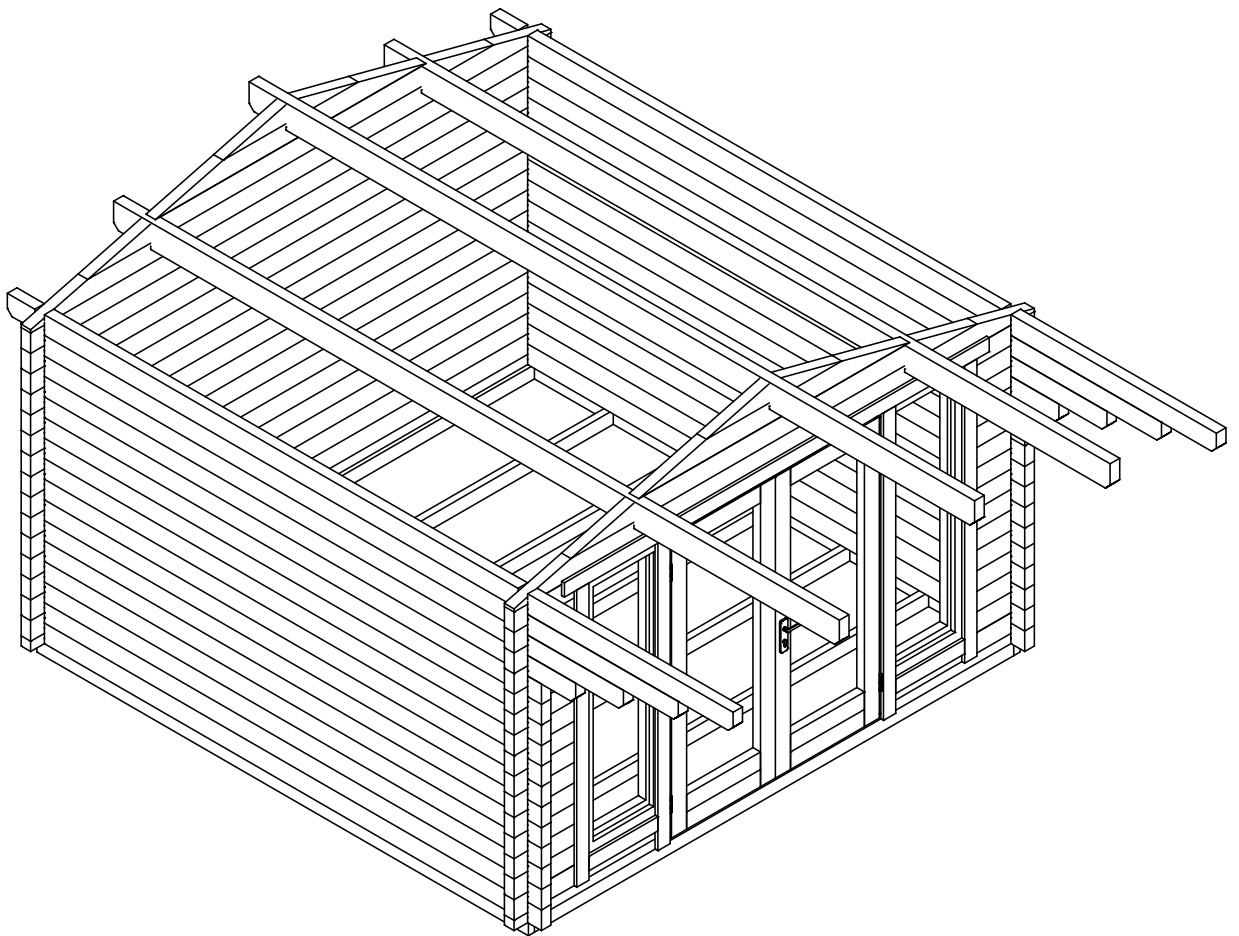

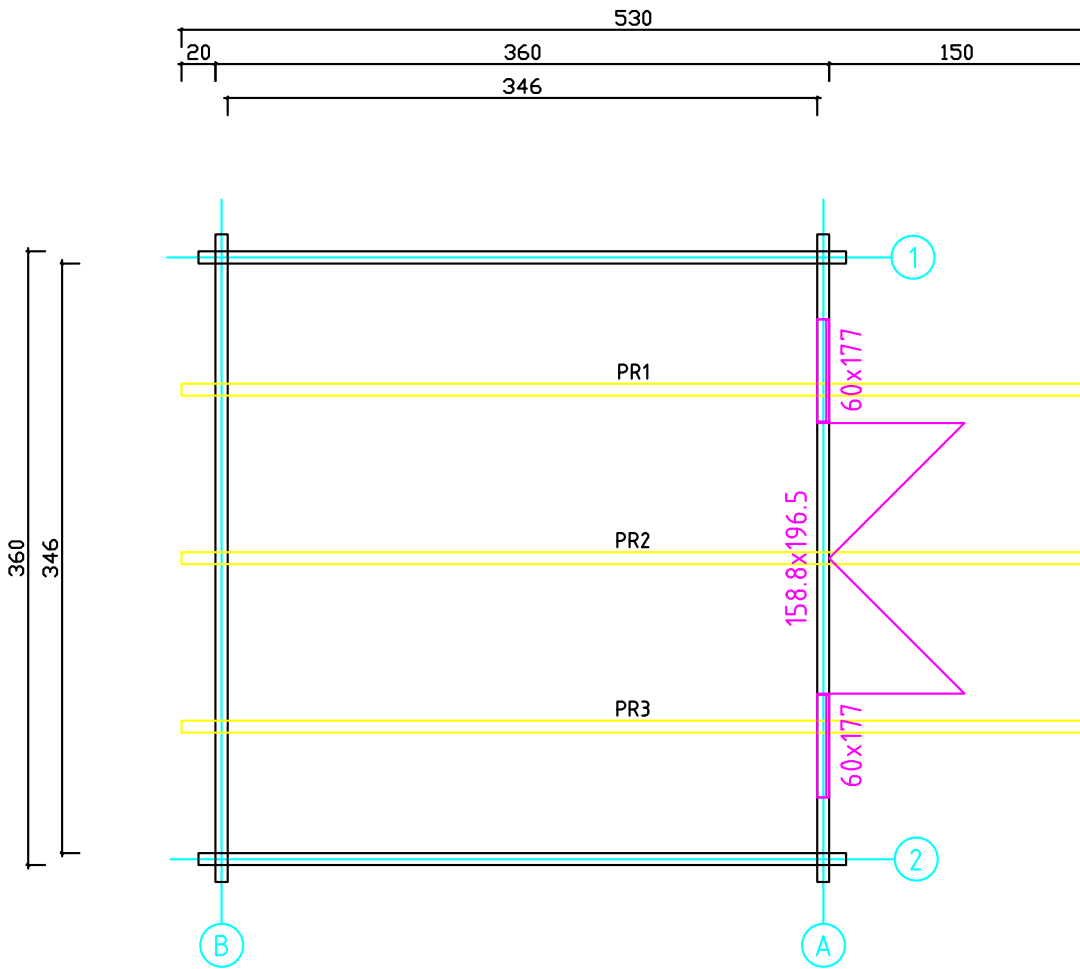

Kontrolliert durch:

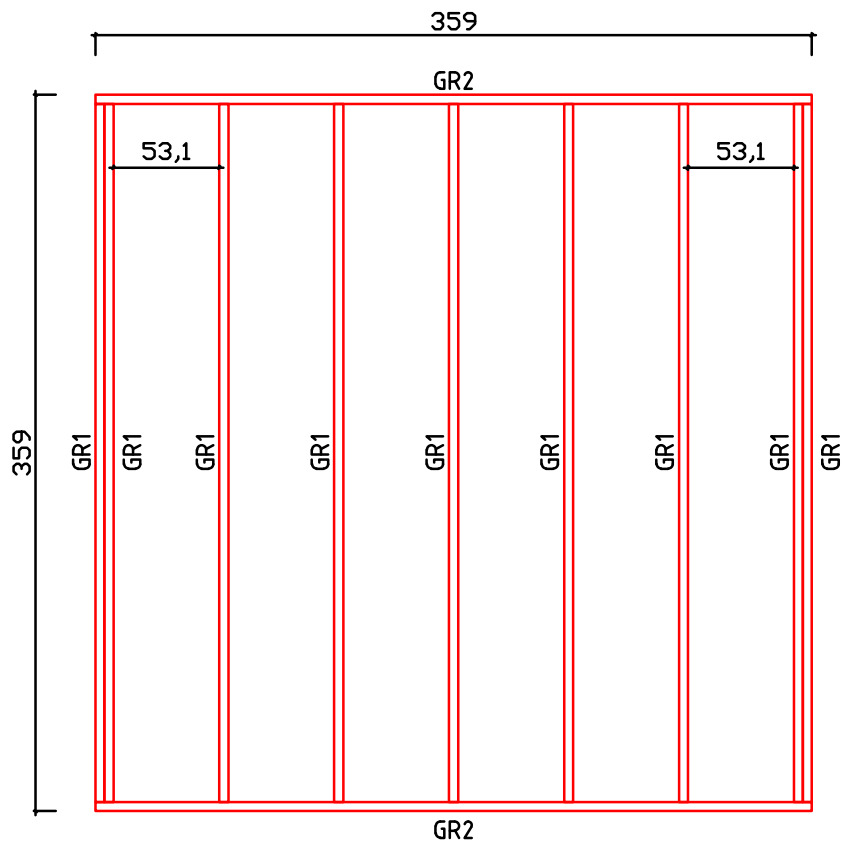

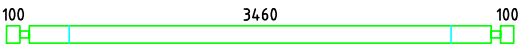
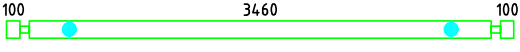
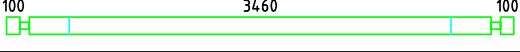
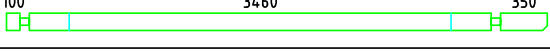
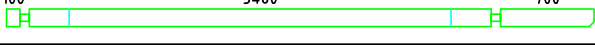
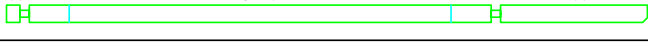
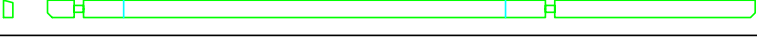
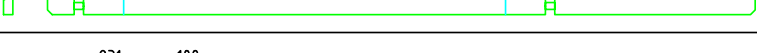
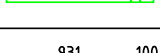
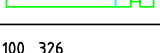

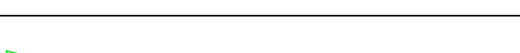

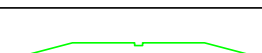
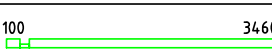

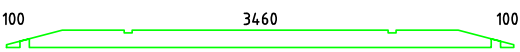
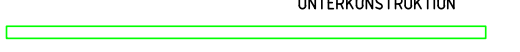
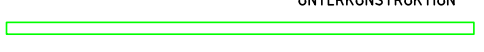
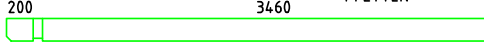
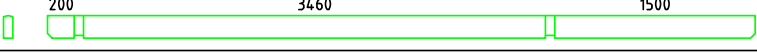
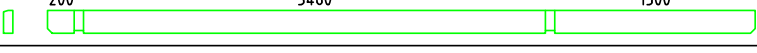
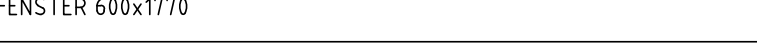



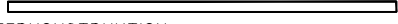





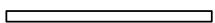

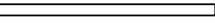

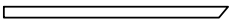

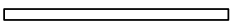



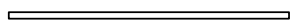

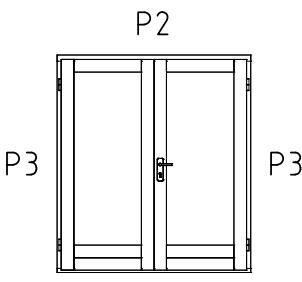
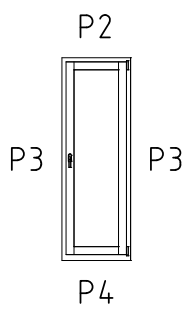

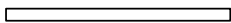
Wir empfehlen als Fundament für Ihr Gartenhaus eine vollflächig festgegründete, gepflasterte oder betonierte Fläche. Wahlweise ist auch ein Punkt- oder Streifenfundament möglich.

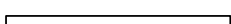

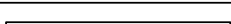
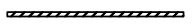
Pos		Stck.	Profil (mm)	Lenght (mm)
001		2	70x130	3800
002		2	70x130	3800
003		20	70x130	3800
004		2	70x130	4050
005		2	70x130	4400
006		2	70x130	4800
007		1	70x130	5300
008		1	70x130	5300
009		2	70x65	1101
010		2	70x130	1101
011		28	70x130	496
012		1	70x130	3800
013		8	70x122	464
014		2	70x130	1917
015		2	70x130	1977
016		1	70x65	3800
017		15	70x130	3800
018		1	70x130	3800
GR2	UNTERKONSTRUKTION 	2	45x90	3590
GR1	UNTERKONSTRUKTION 	9	45x90	3500
PR1	200 3460 1500 PFETTEN 	1	70x170	5300
PR2	200 3460 1500 PFETTEN 	1	70x170	5300
PR3	200 3460 1500 PFETTEN 	1	70x170	5300
	FENSTER 600x1770	2		
	TÜR 1588x1965	1		

Pos		Stck.	Profil (mm)	Lenght (mm)
1	Screws/Schrauben/Vis 5x100 mm- For fixing first row of wall logs /Fixierung des ersten Bohlenkranzes/Pour fixer les lamesde plancher	6		
2	Nails/Nägel/Clous 2.5x50 - For fixing floorboards/ Befestigung Fussbodenbretter/Pour fixer les lames de plancher	280		
3	Nails/Nägel/Clous 2.5x50 - For fixing roofboards/ Befestigung Dachbretter/Pour fixer les voliges	370		
4	Nails/Nägel/Clous 2.5x50 - For fixing floor edge trims/ Befestigung Fussleisten/Pour fixer les plinthes du plancher	30		
5	Nails/Nägel/Clous 2.5x50 - For fixing roofing felt fillet/ Befestigung giebelabschlussbrett/Pour fixer la latte de finition de la couverture	20		
6	Screws/Schrauben/Vis 2,5x50 mm- For fixing roof side boards and roof edge reinforcement Befestigung Traufenbretter und Traufenleisten Pour fixer les planches de rive et le tasseau de refront	44		
7	Screws/Schrauben/Vis 2,5x50 mm- For fixing fascia boards and diamonds/ Befestigung Giebelblende und Raute Pour fixer les planches de rive et le diamant	28		
8	Screws/Schrauben/Vis 2,5x50 mm- For fixing fwindow and door trims/ Befestigung Fenster und türen/ Pour fixer les croisillons des fenetres et des portes	44		
9	Metal storm Brace/Gewindestange/Tige filetee 8 mm	4		
10	Shim;Nuts/Mutter ,U-Scheibe/Ecrou;Rondelle 8 mm For fixing storm braces/ Pour fixer les anti tempete/ Für Sturmleisten Pour fixer les croisillons des fenetres et des portes	4/4		
	Metal storm Brace/Gewindestange/Tige filetee 8 mm KL1 M8 1,95 m 4 Screws 180 8 pcs. Plastic caps 4 pcs. SP 14x390 18 Metallspindeln			

POS	ST.	B	H	L	Teileliste		
GR	Vt. spetsi					UNTERKONSTRUKTION	
F1	12m ²	28		3455		FUSSBODENBRETTER	
PR	3	70	170	5300		PFETTEN	
RB1	22,5m ²	20		2120		DACHBRETTER	
R1	2	20	120	5300		TRAUFENBRETTER	
R2	2	45	65	5300		TRAUFENBRETTER	
R3	4	20	120	2300		GIEBELABSCHLUSSLEISTE	
R4	4	20	45	2300		GIEBELABSCHLUSSLEISTE	
R5	4	45	45	2300		GIEBELABSCHLUSSLEISTE (45 degrees; alla lahti lõigata)	
SK	2	70	65			SCHLAGKLOTZ	
SL1	2	30	30	1720		RUTSCHLEISTE	
SP	18		Ø14	390		METALLSPINDELN	
DR1	1	1588	1965				
WN1	2	600	1770				
P1	15m	20	40			Fussbodenleiste	
P2	1+1	20	90	3090		Türleiste DR1, Fensterleiste WN1	
P3	4+4	20	90	1945		Türleiste DR1, Fensterleiste WN1	
P4	2+2	20	90	560		Fensterleiste WN1	
   							
							

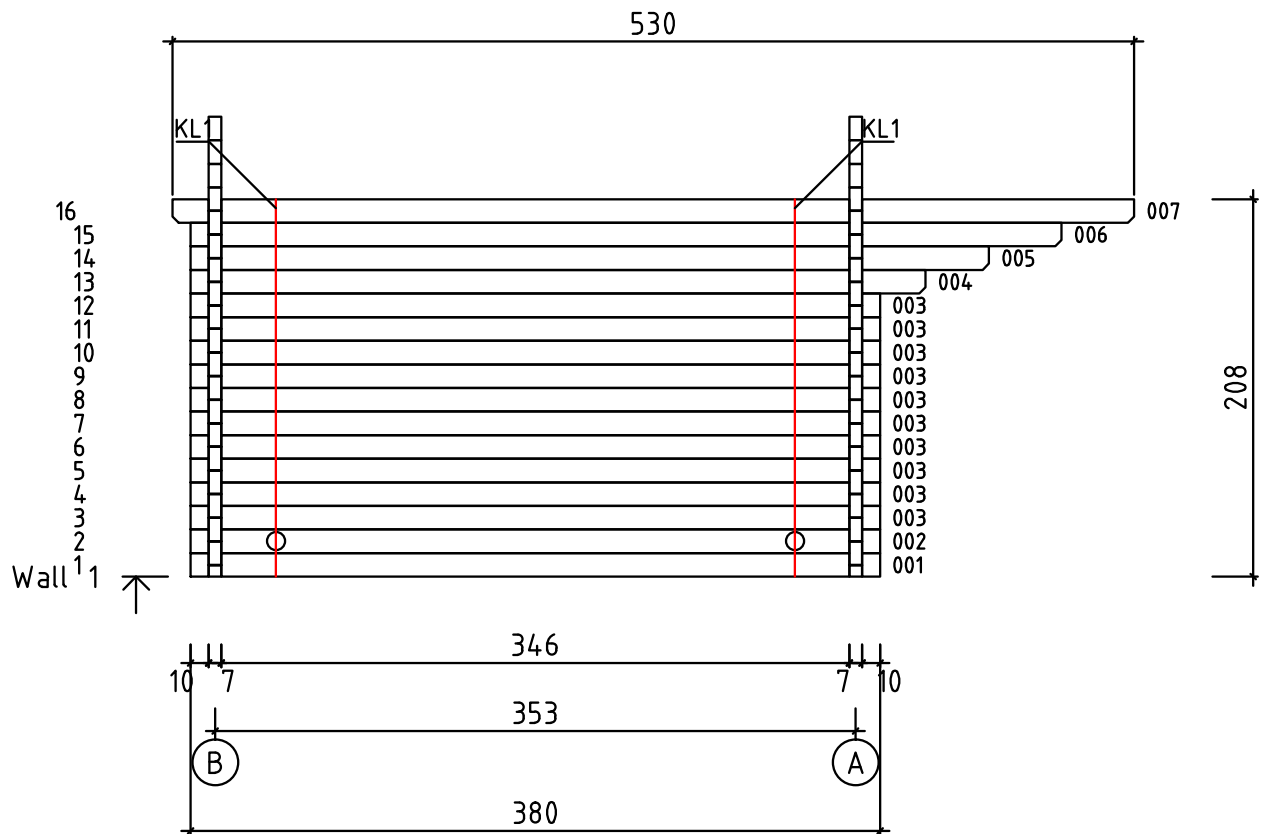

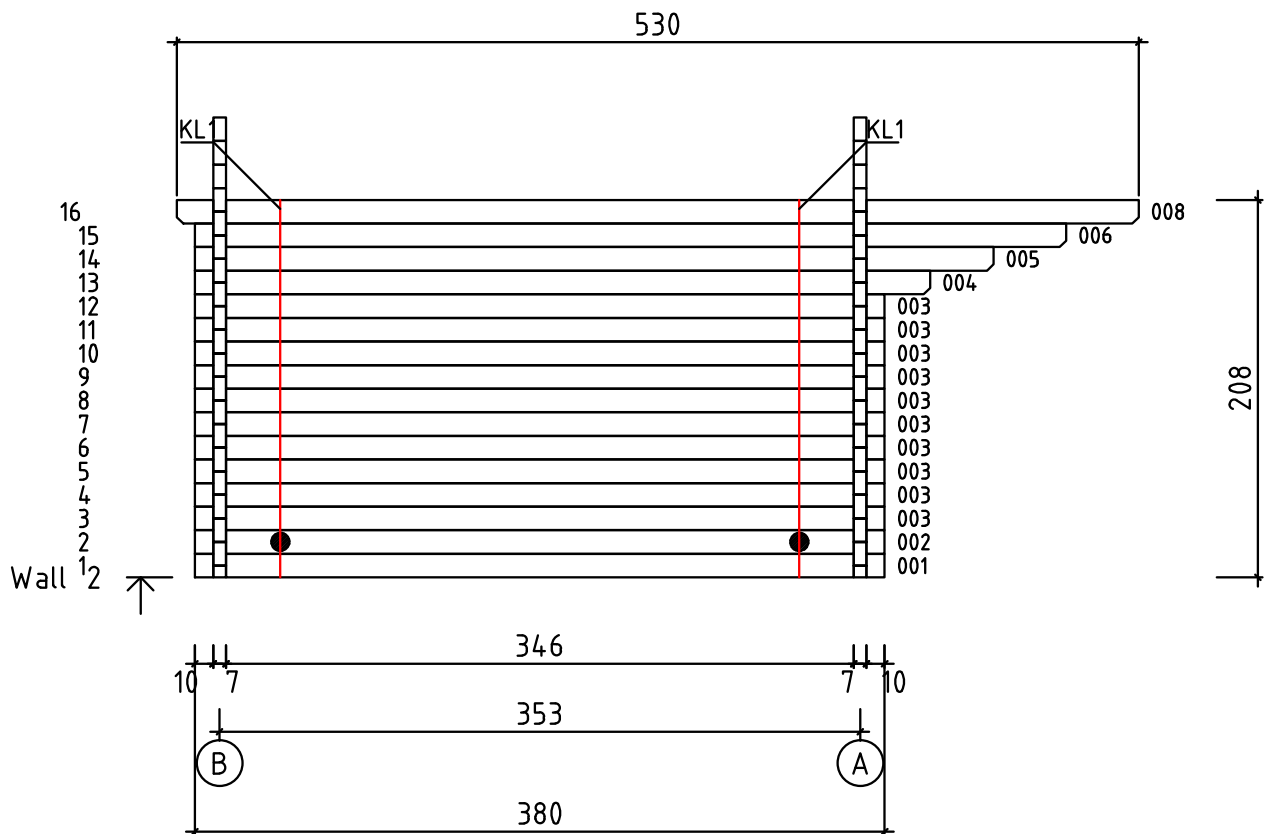

In diese Bohrungen müssen während der Montage nach jeweils drei Blockbohlenreihen Metallspindeln mit dem Durchmesser $\varnothing 14$ mm x 390 mm Länge eingeschlagen werden. Eine nachträgliche Montage dieser Spindeln ist nicht möglich !

